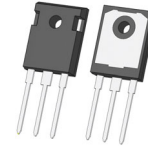

# Silicon Carbide (SiC) Cascode JFET - EliteSiC, Power N-Channel, TO247-3, 1200 V, 80 mohm

## UJ3C120080K3S

 TO247-3 15.90x20.96x5.03, 5.44P  
 CASE 340AK

### Description

This SiC FET device is based on a unique ‘cascode’ circuit configuration, in which a normally-on SiC JFET is co-packaged with a Si MOSFET to produce a normally-off SiC FET device. The device’s standard gate-drive characteristics allows for a true “drop-in replacement” to Si IGBTs, Si FETs, SiC MOSFETs or Si super-junction devices. Available in the TO247-3 package, this device exhibits ultra-low gate charge and exceptional reverse recovery characteristics, making it ideal for switching inductive loads, and any application requiring standard gate drive.

### Features

- Typical On-resistance  $R_{DS(on),typ}$ : 80 mΩ
- Maximum Operating Temperature of 175 °C
- Excellent Reverse Recovery
- Low Gate Charge
- Low Intrinsic Capacitance
- ESD Protected: HBM Class 2 and CDM Class C3
- This Device is Pb-Free, Halogen Free and is RoHS Compliant

### Typical Applications

- EV Charging
- PV Inverters
- Switch Mode Power Supplies
- Power Factor Correction Modules
- Motor Drives
- Induction Heating

### MARKING DIAGRAM

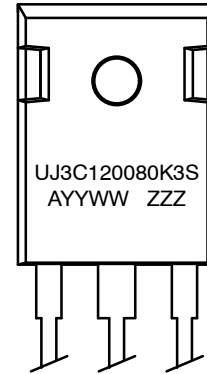

UJ3C120080K3S	= Specific Device Code
A	= Assembly Location
YY	= Year
WW	= Work Week
ZZZ	= Lot ID

### PIN CONNECTIONS

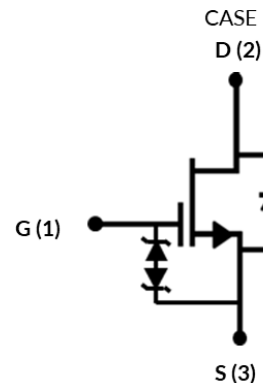

### ORDERING INFORMATION

See detailed ordering and shipping information on page 8 of this data sheet.

# UJ3C120080K3S

## MAXIMUM RATINGS

Parameter	Symbol	Test Conditions	Value	Unit
Drain-source Voltage	$V_{DS}$		1200	V
Gate-source Voltage	$V_{GS}$	DC	-25 to +25	V
Continuous Drain Current (Note 1)	$I_D$	$T_C = 25\text{ }^\circ\text{C}$	33	A
		$T_C = 100\text{ }^\circ\text{C}$	24	A
Pulsed Drain Current (Note 2)	$I_{DM}$	$T_C = 25\text{ }^\circ\text{C}$	77	A
Single Pulsed Avalanche Energy (Note 3)	$E_{AS}$	$L = 15\text{ mH}$ , $I_{AS} = 2.8\text{ A}$	58.5	mJ
Power Dissipation	$P_{tot}$	$T_C = 25\text{ }^\circ\text{C}$	254.2	W
Maximum Junction Temperature	$T_{J,max}$		175	$^\circ\text{C}$
Operating and Storage Temperature	$T_J$ , $T_{STG}$		-55 to 175	$^\circ\text{C}$
Max. Lead Temperature for Soldering, 1/8" from Case for 5 Seconds	$T_L$		250	$^\circ\text{C}$

Stresses exceeding those listed in the Maximum Ratings table may damage the device. If any of these limits are exceeded, device functionality should not be assumed, damage may occur and reliability may be affected.

- Limited by  $T_{J,max}$ .
- Pulse width  $t_p$  limited by  $T_{J,max}$ .
- Starting  $T_J = 25\text{ }^\circ\text{C}$ .

## THERMAL CHARACTERISTICS

Parameter	Symbol	Test Conditions	Min	Typ	Max	Unit
Thermal Resistance, Junction-to-Case	$R_{\theta JC}$		-	0.45	0.59	$^\circ\text{C/W}$

## ELECTRICAL CHARACTERISTICS ( $T_J = +25\text{ }^\circ\text{C}$ unless otherwise specified)

Parameter	Symbol	Test Conditions	Min	Typ	Max	Unit
-----------	--------	-----------------	-----	-----	-----	------

### TYPICAL PERFORMANCE – STATIC

Drain-source Breakdown Voltage	$BV_{DS}$	$V_{GS} = 0\text{ V}$ , $I_D = 1\text{ mA}$	1200	-	-	V	
Total Drain Leakage Current	$I_{DSS}$	$V_{DS} = 1200\text{ V}$ , $V_{GS} = 0\text{ V}$ , $T_J = 25\text{ }^\circ\text{C}$	-	10	75	$\mu\text{A}$	
		$V_{DS} = 1200\text{ V}$ , $V_{GS} = 0\text{ V}$ , $T_J = 175\text{ }^\circ\text{C}$	-	50	-		
Total Gate Leakage Current	$I_{GSS}$	$V_{DS} = 0\text{ V}$ , $T_J = 25\text{ }^\circ\text{C}$ , $V_{GS} = -20\text{ V} / +20\text{ V}$	-	6	$\pm 20$	$\mu\text{A}$	
Drain-source On-resistance	$R_{DS(on)}$	$V_{GS} = 12\text{ V}$ , $I_D = 20\text{ A}$	$T_J = 25\text{ }^\circ\text{C}$	-	80	100	m $\Omega$
			$T_J = 125\text{ }^\circ\text{C}$	-	130	-	
			$T_J = 175\text{ }^\circ\text{C}$	-	172	-	
Gate Threshold Voltage	$V_{G(th)}$	$V_{DS} = 5\text{ V}$ , $I_D = 10\text{ mA}$	4	5	6	V	
Gate Resistance	$R_G$	$f = 1\text{ MHz}$ , open drain	-	4.5	-	$\Omega$	

### TYPICAL PERFORMANCE – REVERSE DIODE

Diode Continuous Forward Current (Note 4)	$I_S$	$T_C = 25\text{ }^\circ\text{C}$	-	-	33	A
Diode Pulse Current (Note 5)	$I_{S,pulse}$	$T_C = 25\text{ }^\circ\text{C}$	-	-	77	A
Forward Voltage	$V_{FSD}$	$V_{GS} = 0\text{ V}$ , $I_S = 10\text{ A}$ , $T_J = 25\text{ }^\circ\text{C}$	-	1.5	2	V
		$V_{GS} = 0\text{ V}$ , $I_S = 10\text{ A}$ , $T_J = 175\text{ }^\circ\text{C}$	-	2	-	
Reverse Recovery Charge	$Q_{rr}$	$V_{DS} = 800\text{ V}$ , $I_S = 20\text{ A}$ , $V_{GS} = 0\text{ V}$ , $R_{G,EXT} = 10\text{ }^\circ\Omega$ , $di/dt = 2200\text{ A}/\mu\text{s}$ , $T_J = 150\text{ }^\circ\text{C}$	-	180	-	nC
Reverse Recovery Time	$t_{rr}$		-	30	-	ns

# UJ3C120080K3S

## ELECTRICAL CHARACTERISTICS ( $T_J = +25\text{ }^\circ\text{C}$ unless otherwise specified) (continued)

Parameter	Symbol	Test Conditions	Min	Typ	Max	Unit
<b>TYPICAL PERFORMANCE – DYNAMIC</b>						
Input Capacitance	$C_{iss}$	$V_{DS} = 100\text{ V}, V_{GS} = 0\text{ V},$ $f = 100\text{ kHz}$	–	1500	–	pF
Output Capacitance	$C_{oss}$		–	100	–	
Reverse Transfer Capacitance	$C_{rss}$		–	2.1	–	
Effective Output Capacitance, Energy Related	$C_{oss(er)}$	$V_{DS} = 0\text{ V to } 800\text{ V}, V_{GS} = 0\text{ V}$	–	59	–	pF
Effective Output Capacitance, Time Related	$C_{oss(tr)}$		–	136	–	pF
$C_{oss}$ Stored Energy	$E_{oss}$	$V_{DS} = 800\text{ V}, V_{GS} = 0\text{ V}$	–	19	–	$\mu\text{J}$
Total Gate Charge	$Q_G$	$V_{DS} = 800\text{ V}, I_D = 20\text{ A},$ $V_{GS} = -5\text{ V to } 15\text{ V}$	–	51	–	nC
Gate-drain Charge	$Q_{GD}$		–	11	–	
Gate-source Charge	$Q_{GS}$		–	19	–	
Turn-on Delay Time	$t_{d(on)}$	$V_{DS} = 800\text{ V}, I_D = 20\text{ A},$ Gate Driver = $-5\text{ V to } +15\text{ V},$ Turn-on $R_{G\_EXT} = 1\ \Omega,$ Turn-off $R_{G\_EXT} = 20\ \Omega,$ Inductive Load, FWD: UJ2D1215T, $T_J = 150\text{ }^\circ\text{C}$	–	22	–	ns
Rise Time	$t_r$		–	14	–	
Turn-off Delay Time	$t_{d(off)}$		–	61	–	
Fall Time	$t_f$		–	14	–	
Turn-on Energy	$E_{ON}$		–	260	–	$\mu\text{J}$
Turn-off Energy	$E_{OFF}$		–	108	–	
Total Switching Energy	$E_{TOTAL}$	–	368	–		

Product parametric performance is indicated in the Electrical Characteristics for the listed test conditions, unless otherwise noted. Product performance may not be indicated by the Electrical Characteristics if operated under different conditions.

4. Limited by  $T_{J,max}$ .

5. Pulse width  $t_p$  limited by  $T_{J,max}$ .

TYPICAL PERFORMANCE DIAGRAMS

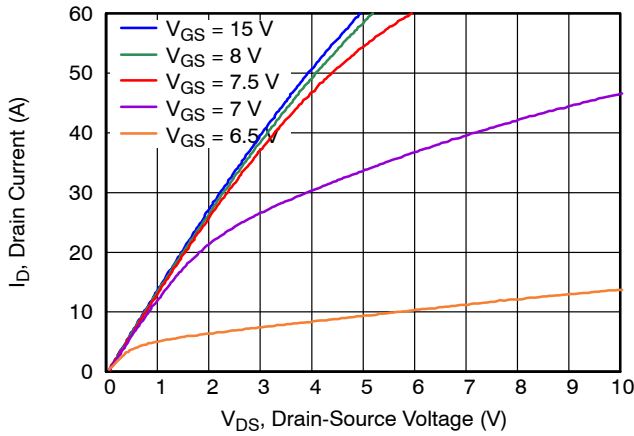

Figure 1. Typical Output Characteristics at  $T_J = -55\text{ }^\circ\text{C}$ ,  $t_p < 250\text{ }\mu\text{s}$

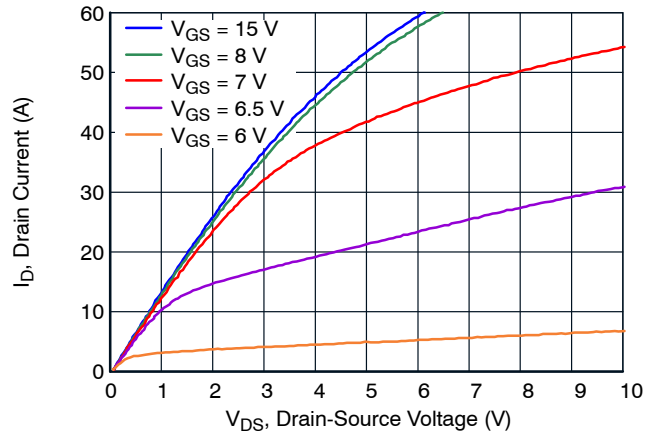

Figure 2. Typical Output Characteristics at  $T_J = 25\text{ }^\circ\text{C}$ ,  $t_p < 250\text{ }\mu\text{s}$

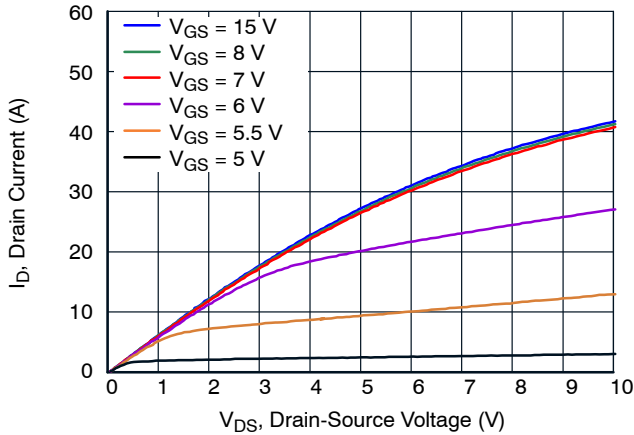

Figure 3. Typical Output Characteristics at  $T_J = 175\text{ }^\circ\text{C}$ ,  $t_p < 250\text{ }\mu\text{s}$

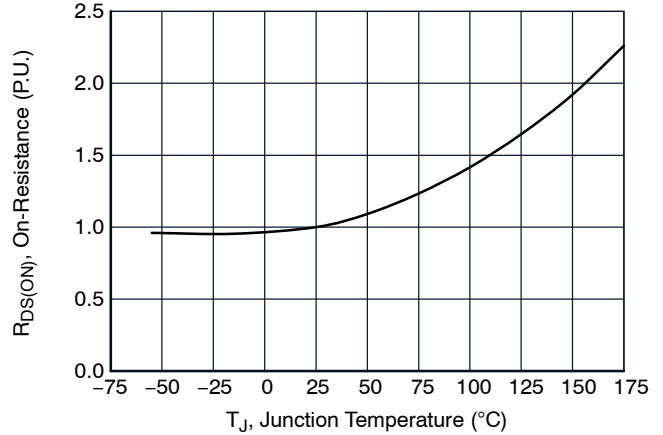

Figure 4. Normalized On-Resistance vs. Temperature at  $V_{GS} = 12\text{ V}$  and  $I_D = 20\text{ A}$

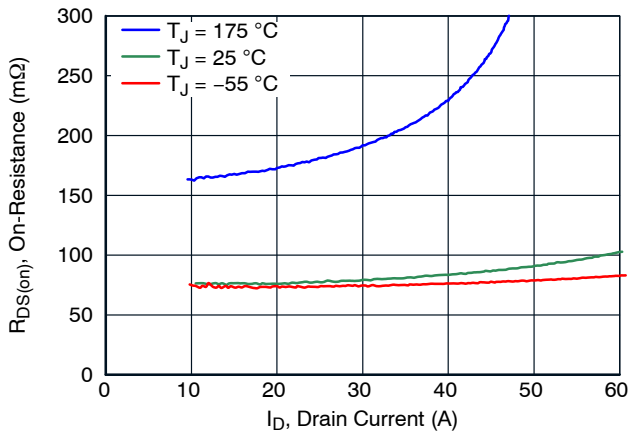

Figure 5. Typical Drain-Source On-Resistances at  $V_{GS} = 12\text{ V}$

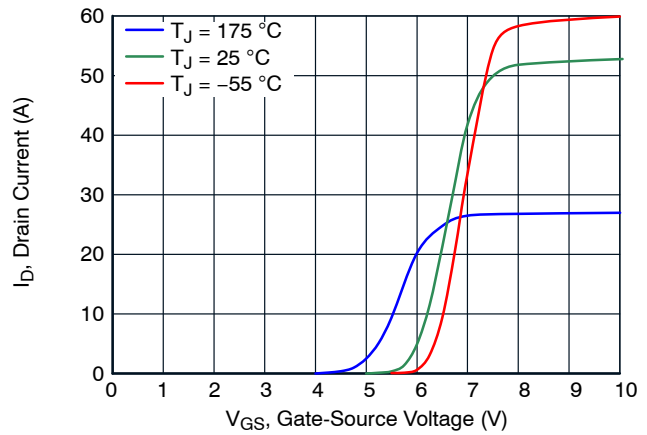

Figure 6. Typical Transfer Characteristics at  $V_{DS} = 5\text{ V}$

TYPICAL PERFORMANCE DIAGRAMS (continued)

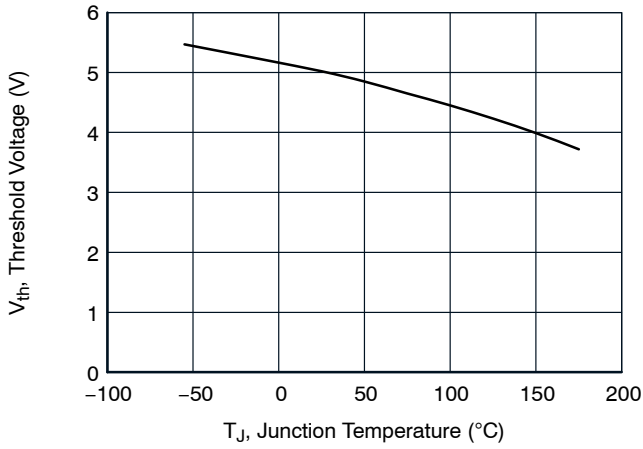

Figure 7. Threshold Voltage vs. Junction Temperature at  $V_{DS} = 5\text{ V}$  and  $I_D = 10\text{ mA}$

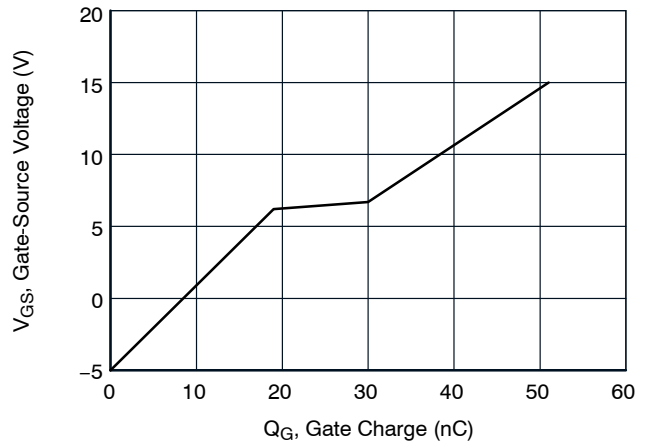

Figure 8. Typical Gate Charge at  $V_{DS} = 800\text{ V}$  and  $I_D = 20\text{ A}$

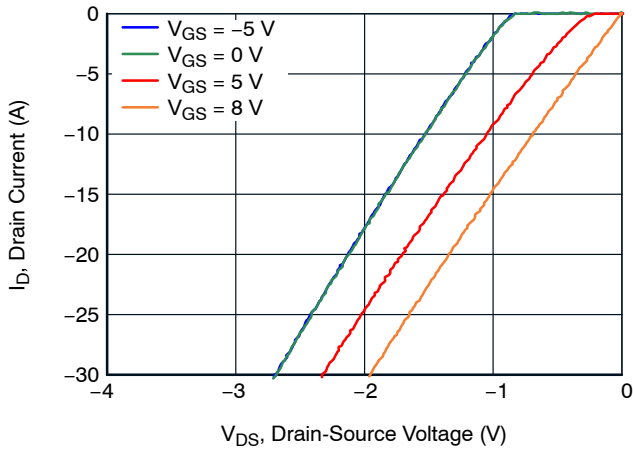

Figure 9. 3<sup>rd</sup> Quadrant Characteristics at  $T_J = -55\text{ }^\circ\text{C}$

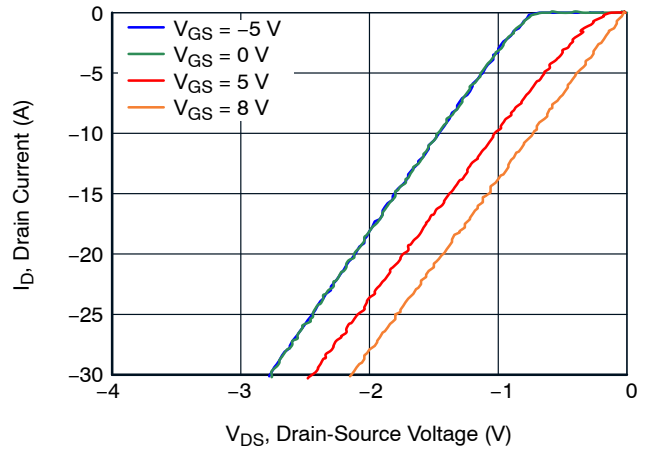

Figure 10. 3<sup>rd</sup> Quadrant Characteristics at  $T_J = 25\text{ }^\circ\text{C}$

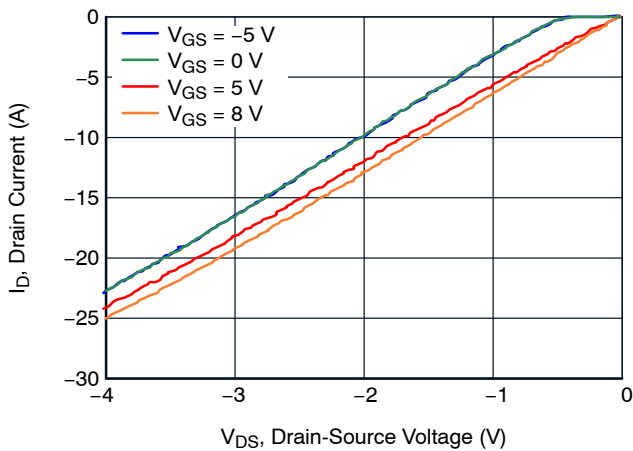

Figure 11. 3<sup>rd</sup> Quadrant Characteristics at  $T_J = 175\text{ }^\circ\text{C}$

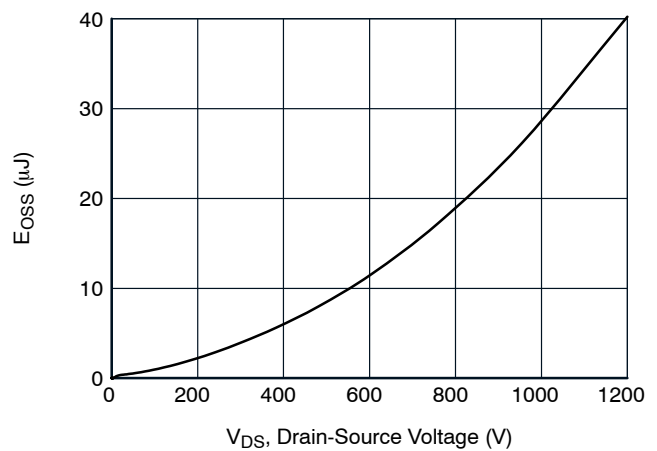

Figure 12. Typical Stored Energy in  $C_{OSS}$  at  $V_{GS} = 0\text{ V}$

TYPICAL PERFORMANCE DIAGRAMS (continued)

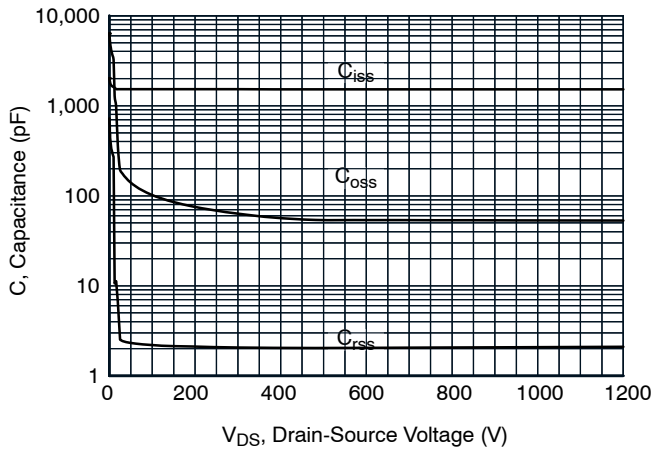

Figure 13. Typical Capacitances at  $f = 100 \text{ kHz}$  and  $V_{GS} = 0 \text{ V}$

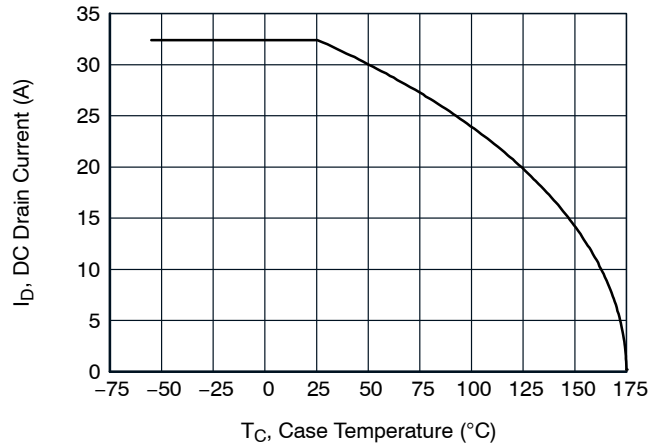

Figure 14. DC Drain Current Derating

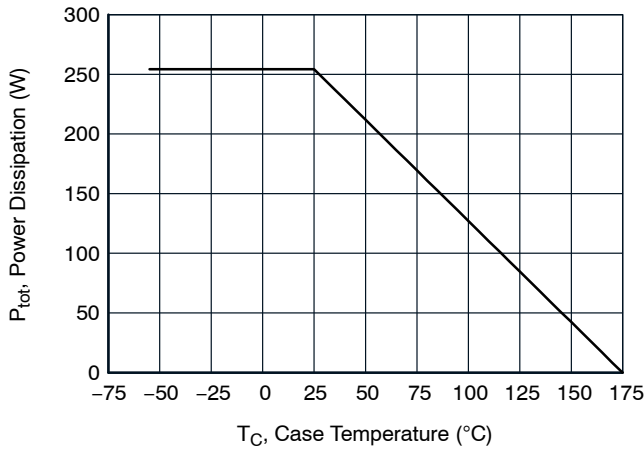

Figure 15. Total Power Dissipation

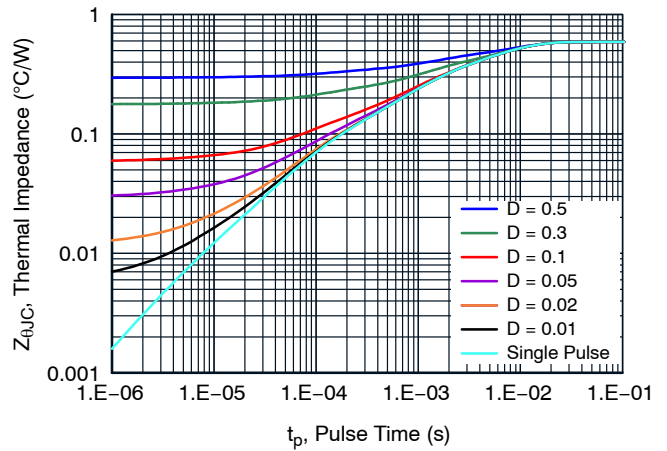

Figure 16. Maximum Transient Thermal Impedance

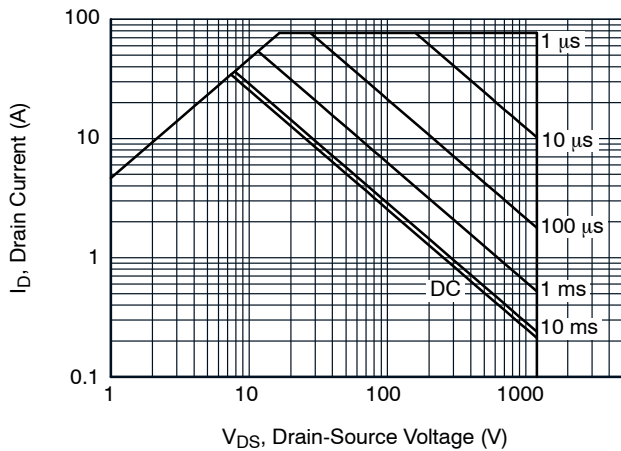

Figure 17. Safe Operation Area at  $T_C = 25 \text{ °C}$ ,  $D = 0$ , Parameter  $t_p$

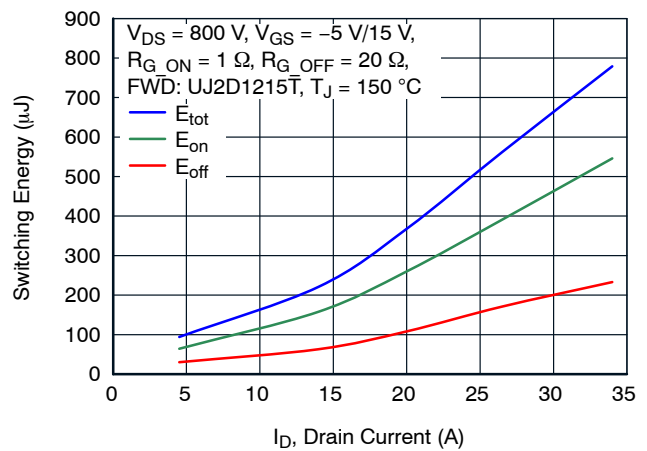
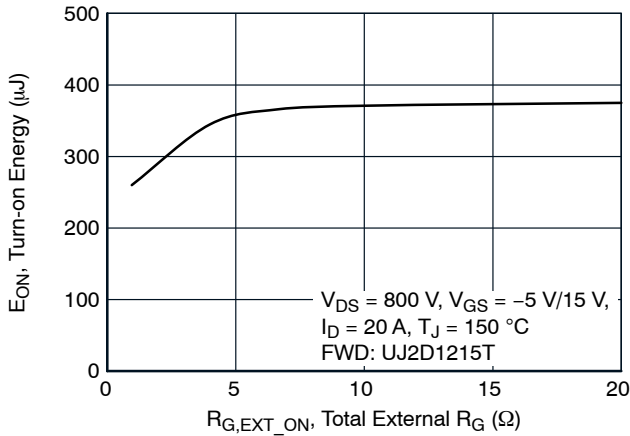
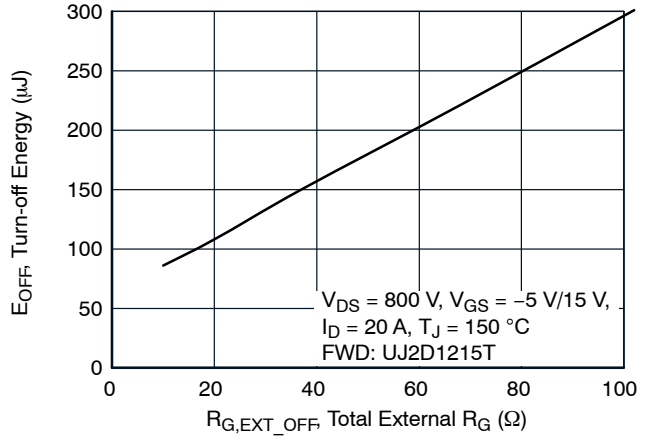

Figure 18. Clamped Inductive Switching Energy vs. Drain Current at  $T_J = 150 \text{ °C}$

TYPICAL PERFORMANCE DIAGRAMS (continued)



**Figure 19. Clamped Inductive Switching Turn-on Energy vs.  $R_{G,EXT\_ON}$**



**Figure 20. Clamped Inductive Switching Turn-off Energy vs.  $R_{G,EXT\_OFF}$**

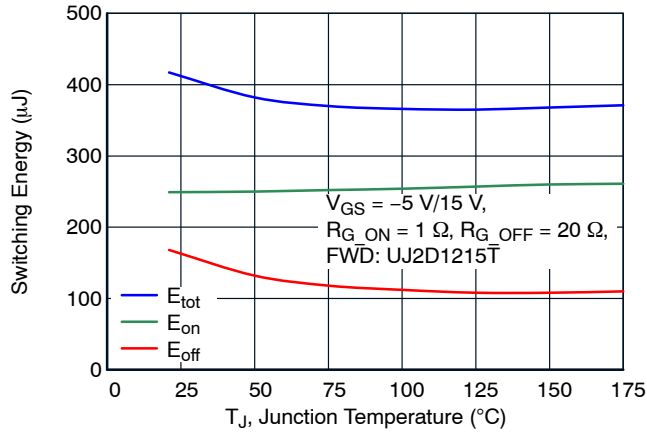

**Figure 21. Clamped Inductive Switching Energy vs. Junction Temperature at  $V_{DS} = 800\text{ V}$  and  $I_D = 20\text{ A}$**

# UJ3C120080K3S

## APPLICATIONS INFORMATION

SiC FETs are enhancement-mode power switches formed by a high-voltage SiC depletion-mode JFET and a low-voltage silicon MOSFET connected in series. The silicon MOSFET serves as the control unit while the SiC JFET provides high voltage blocking in the off state. This combination of devices in a single package provides compatibility with standard gate drivers and offers superior performance in terms of low on-resistance ( $R_{DS(on)}$ ), output capacitance ( $C_{oss}$ ), gate charge ( $Q_G$ ), and reverse recovery charge ( $Q_{rr}$ ) leading to low conduction and switching losses. The SiC FETs also provide excellent reverse conduction capability eliminating the need for an external anti-parallel diode.

Like other high performance power switches, proper PCB layout design to minimize circuit parasitics is strongly recommended due to the high  $dv/dt$  and  $di/dt$  rates. An external gate resistor is recommended when the FET is working in the diode mode in order to achieve the optimum

reverse recovery performance. For more information on SiC FET operation, see [www.onsemi.com](http://www.onsemi.com).

A snubber circuit with a small  $R_{(G)}$ , or gate resistor, provides better EMI suppression with higher efficiency compared to using a high  $R_{(G)}$  value. There is no extra gate delay time when using the snubber circuitry, and a small  $R_{(G)}$  will better control both the turn-off  $V_{(DS)}$  peak spike and ringing duration, while a high  $R_{(G)}$  will damp the peak spike but result in a longer delay time. In addition, the total switching loss when using a snubber circuit is less than using high  $R_{(G)}$ , while greatly reducing  $E_{(OFF)}$  from mid-to-full load range with only a small increase in  $E_{(ON)}$ . Efficiency will therefore improve with higher load current. For more information on how a snubber circuit will improve overall system performance, visit the **onsemi** website at [www.onsemi.com](http://www.onsemi.com).

## ORDERING INFORMATION

Part Number	Marking	Package	Shipping
UJ3C120080K3S	UJ3C120080K3S	TO247-3 15.90x20.96x5.03, 5.44P (Pb-Free, Halogen Free)	600 / Tube

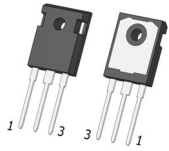

TO247-3 15.90x20.96x5.03, 5.44P  
CASE 340AK  
ISSUE B

DATE 14 APR 2025

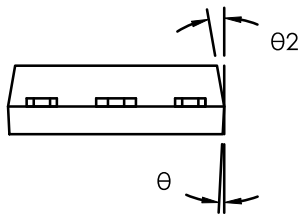
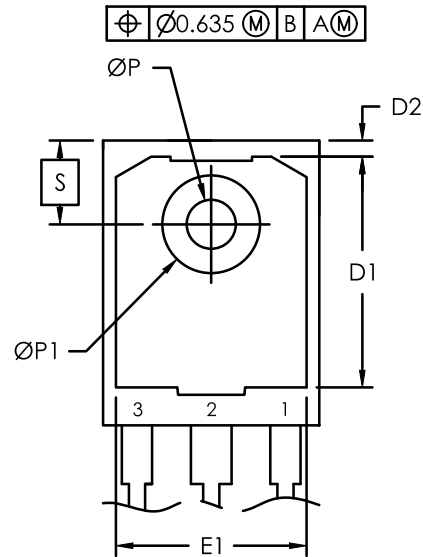
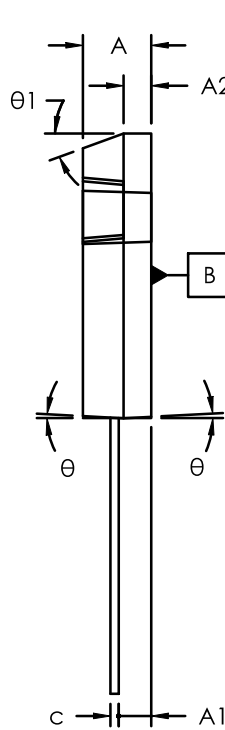
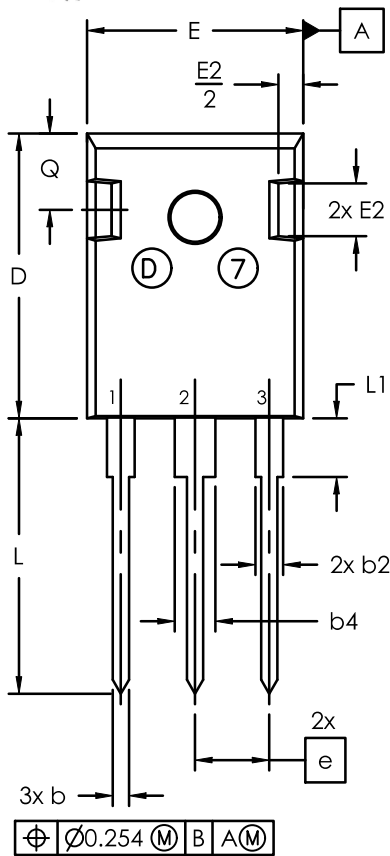

NOTE:

1. Dimensioning and tolerancing as per ASME Y14.5 - 2018
2. Controlling dimension : millimeters
3. Package Outline in compliance with JEDEC standard var. AD.
4. Dimensions D & E does not include mold flash.
5. ØP to have max draft angle of 1.7° to the top with max. hole diameter of 3.91mm.

SYM	millimeters		
	MIN	NOM	MAX
A	4.70	5.03	5.31
A1	2.21	2.40	2.59
A2	1.50	2.03	2.49
b	0.99	1.20	1.40
b2	1.65	2.03	2.39
b4	2.59	3.00	3.43
c	0.38	0.60	0.89
D	20.70	20.96	21.46
D1	13.08	—	—
D2	0.51	1.19	1.35
E	15.49	15.90	16.26
e	5.44 BSC		
E1	13.00	13.30	13.60
E2	3.43	3.89	5.20
L	19.62	20.27	20.32
L1	—	—	4.50
ØP	3.40	3.60	3.80
ØP1	7.06	7.19	7.39
Q	5.38	5.62	6.20
S	6.15 BSC		
Ø	3°		
Ø1	20°		
Ø2	10°		

DOCUMENT NUMBER:	98AON88794E	Electronic versions are uncontrolled except when accessed directly from the Document Repository. Printed versions are uncontrolled except when stamped "CONTROLLED COPY" in red.
DESCRIPTION:	TO247-3 15.90x20.96x5.03, 5.44P	PAGE 1 OF 1

onsemi and ONSEMI are trademarks of Semiconductor Components Industries, LLC dba onsemi or its subsidiaries in the United States and/or other countries. onsemi reserves the right to make changes without further notice to any products herein. onsemi makes no warranty, representation or guarantee regarding the suitability of its products for any particular purpose, nor does onsemi assume any liability arising out of the application or use of any product or circuit, and specifically disclaims any and all liability, including without limitation special, consequential or incidental damages. onsemi does not convey any license under its patent rights nor the rights of others.

**onsemi**, **Onsemi**, and other names, marks, and brands are registered and/or common law trademarks of Semiconductor Components Industries, LLC dba "**onsemi**" or its affiliates and/or subsidiaries in the United States and/or other countries. **onsemi** owns the rights to a number of patents, trademarks, copyrights, trade secrets, and other intellectual property. A listing of **onsemi**'s product/patent coverage may be accessed at [www.onsemi.com/site/pdf/Patent-Marking.pdf](http://www.onsemi.com/site/pdf/Patent-Marking.pdf). **onsemi** reserves the right to make changes at any time to any products or information herein, without notice. The information herein is provided "as-is" and **onsemi** makes no warranty, representation or guarantee regarding the accuracy of the information, product features, availability, functionality, or suitability of its products for any particular purpose, nor does **onsemi** assume any liability arising out of the application or use of any product or circuit, and specifically disclaims any and all liability, including without limitation special, consequential or incidental damages. Buyer is responsible for its products and applications using **onsemi** products, including compliance with all laws, regulations and safety requirements or standards, regardless of any support or applications information provided by **onsemi**. "Typical" parameters which may be provided in **onsemi** data sheets and/or specifications can and do vary in different applications and actual performance may vary over time. All operating parameters, including "Typicals" must be validated for each customer application by customer's technical experts. **onsemi** does not convey any license under any of its intellectual property rights nor the rights of others. **onsemi** products are not designed, intended, or authorized for use as a critical component in life support systems or any FDA Class 3 medical devices or medical devices with a same or similar classification in a foreign jurisdiction or any devices intended for implantation in the human body. Should Buyer purchase or use **onsemi** products for any such unintended or unauthorized application, Buyer shall indemnify and hold **onsemi** and its officers, employees, subsidiaries, affiliates, and distributors harmless against all claims, costs, damages, and expenses, and reasonable attorney fees arising out of, directly or indirectly, any claim of personal injury or death associated with such unintended or unauthorized use, even if such claim alleges that **onsemi** was negligent regarding the design or manufacture of the part. **onsemi** is an Equal Opportunity/Affirmative Action Employer. This literature is subject to all applicable copyright laws and is not for resale in any manner.

## ADDITIONAL INFORMATION

### TECHNICAL PUBLICATIONS:

Technical Library: [www.onsemi.com/design/resources/technical-documentation](http://www.onsemi.com/design/resources/technical-documentation)  
onsemi Website: [www.onsemi.com](http://www.onsemi.com)

### ONLINE SUPPORT: [www.onsemi.com/support](http://www.onsemi.com/support)

For additional information, please contact your local Sales Representative at [www.onsemi.com/support/sales](http://www.onsemi.com/support/sales)