

Silicon Carbide (SiC) Cascode JFET Module – EliteSiC, Full-Bridge Module, 1200 V, 35 mohm

UFB25SC12E1BC3N

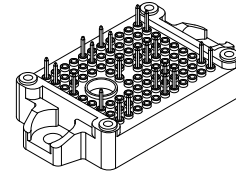

PIM20 33.80x42.50x12.00 E1B
 FULL BRIDGE (SOLDER PIN)
 CASE 180DG

Description

This SiC FET device is based on a unique ‘cascode’ circuit configuration, in which a normally-on SiC JFET is co-packaged with a Si MOSFET to produce a normally-off SiC FET device. The device’s silicon-like gate-drive characteristics allows the use of unipolar gate drives, compatible with Si IGBTs, Si FETs, SiC MOSFETs or Si superjunction devices. Available in the E1B module package, this device exhibits ultra-low gate charge and exceptional reverse recovery characteristics, making it ideal for switching inductive loads, and any application requiring standard gate drive. Advanced Ag sintering die attach technology gives the module superior thermal performance.

Features

- On-resistance $R_{DS(on)}$: 35 m Ω (Typ)
- Operating Temperature: 150 °C (Max)
- Excellent Reverse Recovery: Q_{rr} = 244 nC
- Low Body Diode Voltage : V_{FSD} = 1.4 V
- Low Gate Charge: Q_G = 42.5 nC
- Threshold Voltage $V_{G(th)}$: 5 V (Typ) Allowing 0 to 15 V Drive
- Low Intrinsic Capacitance
- ESD Protected: HBM Class 2 and CDM Class C3
- This Device is Pb-Free, Halogen Free and is RoHS Compliant

Typical Applications

- EV Charging
- PV Inverters
- Switch Mode Power Supplies
- Power Factor Correction Modules
- Motor Drives
- Induction Heating

MARKING DIAGRAM



UFB25SC12E1BC3N = Specific Device Code
 A = Assembly Location
 YY = Year
 WW = Work Week

PIN CONNECTIONS

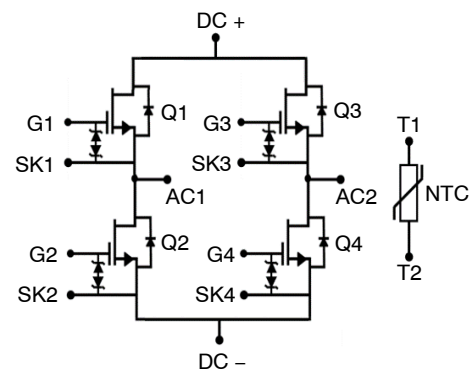

ORDERING INFORMATION

See detailed ordering and shipping information on page 9 of this data sheet.

UFB25SC12E1BC3N

MAXIMUM RATINGS

Parameter	Symbol	Test Conditions	Value	Unit
Drain-source Voltage	V_{DS}		1200	V
Gate-source Voltage	V_{GS}	DC	-20 to +20	V
		AC ($f > 1$ Hz)	-25 to +25	
Continuous Drain Current (Note 1)	I_D	$T_C = 25$ °C	36	A
		$T_C = 90$ °C	25	
Pulsed Drain Current (Note 2)	I_{DM}	$T_C = 25$ °C	175	A
Power Dissipation per Switch	P_{tot}	$T_C = 25$ °C	114	W
Maximum Junction Temperature	$T_{J,max}$		150	°C
Operating and Storage Temperature	T_J, T_{STG}		-55 to 150	°C

Stresses exceeding those listed in the Maximum Ratings table may damage the device. If any of these limits are exceeded, device functionality should not be assumed, damage may occur and reliability may be affected.

- Limited by $T_{J,max}$
- Pulse width t_p limited by $T_{J,max}$

THERMAL CHARACTERISTICS

Parameter	Symbol	Test Conditions	Min	Typ	Max	Unit
Thermal Resistance, Junction-to-Case per Switch	$R_{\theta JC}$		-	0.85	1.1	°C/W

NTC THERMISTOR CHARACTERISTICS

Parameter	Symbol	Test Conditions	Min	Typ	Max	Unit
Rated Resistance	R_{25}	$T_{NTC} = 25$ °C	-	5	-	k Ω
Resistance Value Tolerance	$\Delta R/R$	$T_{NTC} = 25$ °C	-5	-	5	%
Power Dissipation	P_{25}	$T_{NTC} = 25$ °C	-	-	20	mW
B Constant	$B_{25/50}$	$R_2 = R_{25} \exp [B_{25/50} (1/T_2 - 1/(298.15 K))]$	-	3375	-	K

MODULE

Parameter	Symbol	Test Conditions	Value	Unit
Isolation Voltage	V_{ISOL}	RMS, $f = 50$ Hz, $t = 1$ min	3	kV
Internal Isolation			Al_2O_3	
Creepage Distance		Terminal to heatsink	12.7	mm
		Terminal to terminal	6.3	
Clearance Distance		Terminal to heatsink	10	mm
		Terminal to terminal	5	
Stray Inductance Module	L_{sCE}		11	nH

UFB25SC12E1BC3N

ELECTRICAL CHARACTERISTICS (T_J = +25 °C unless otherwise specified)

Parameter	Symbol	Test Conditions	Min	Typ	Max	Unit
TYPICAL PERFORMANCE – STATIC						
Drain-source Breakdown Voltage	BV _{DS}	V _{GS} = 0 V, I _D = 4 mA	1200	–	–	V
Total Drain Leakage Current	I _{DSS}	V _{DS} = 1200 V, V _{GS} = 0 V, T _J = 25 °C	–	8	150	μA
		V _{DS} = 1200 V, V _{GS} = 0 V, T _J = 150 °C	–	35	–	
Total Gate Leakage Current	I _{GSS}	V _{DS} = 0 V, T _J = 25 °C, V _{GS} = -20 V / +20 V	–	6	20	μA
Drain-source On-resistance	R _{DS(on)}	V _{GS} = 12 V, I _D = 25 A, T _J = 25 °C	–	35	45	mΩ
		V _{GS} = 12 V, I _D = 25 A, T _J = 125 °C	–	55	–	
		V _{GS} = 12 V, I _D = 25 A, T _J = 150 °C	–	64	–	
Gate Threshold Voltage	V _{G(th)}	V _{DS} = 5 V, I _D = 10 mA	4	5	6	V
Gate Resistance	R _G	f = 1 MHz, open drain	–	4.5	–	Ω
TYPICAL PERFORMANCE – REVERSE DIODE						
Diode Continuous Forward Current (Note 1)	I _S	T _C = 25 °C	–	–	36	A
Diode Pulse Current (Note 2)	I _{S,pulse}	T _C = 25 °C	–	–	175	A
Forward Voltage	V _{FSD}	V _{GS} = 0 V, I _S = 20 A, T _J = 25 °C	–	1.4	2	V
		V _{GS} = 0 V, I _S = 20 A, T _J = 150 °C	–	1.8	–	
Reverse Recovery Charge	Q _{rr}	V _{DS} = 800 V, I _S = 25 A, V _{GS} = 0 V, R _G = 33 Ω, di/dt = 2200 A/μs, T _J = 25 °C	–	244	–	nC
Reverse Recovery Time	t _{rr}		–	29	–	ns
Reverse Recovery Charge	Q _{rr}	V _{DS} = 800 V, I _S = 25 A, V _{GS} = 0 V, R _G = 33 Ω, di/dt = 2200 A/μs, T _J = 150 °C	–	227	–	nC
Reverse Recovery Time	t _{rr}		–	28	–	ns
TYPICAL PERFORMANCE – DYNAMIC						
Input Capacitance	C _{iss}	V _{DS} = 800 V, V _{GS} = 0 V, f = 100 kHz	–	1450	–	pF
Output Capacitance	C _{oss}		–	94	–	
Reverse Transfer Capacitance	C _{rss}		–	1.7	–	
Effective Output Capacitance, Energy Related	C _{oss(er)}	V _{DS} = 0 V to 800 V, V _{GS} = 0 V	–	120	–	pF
Effective Output Capacitance, Time Related	C _{oss(tr)}		–	265	–	pF
C _{oss} Stored Energy	E _{oss}	V _{DS} = 800 V, V _{GS} = 0 V	–	38	–	μJ
Total gate Charge	Q _G	V _{DS} = 800 V, I _D = 25 A, V _{GS} = -5 V to 15 V	–	42.5	–	nC
Gate-drain Charge	Q _{GD}		–	9.5	–	
Gate-source Charge	Q _{GS}		–	15.5	–	
Turn-on Delay Time	t _{d(on)}	V _{DS} = 800 V, I _D = 25 A, Gate Driver = -5 V to +15 V, R _{G ON} = 22 Ω, R _{G OFF} = 22 Ω, Inductive Load, FWD: same device with V _{GS} = 0 V and R _G = 22 Ω, T _J = 25 °C (Notes 3, 4)	–	53	–	ns
Rise Time	t _r		–	15	–	
Turn-off Delay Time	t _{d(off)}		–	54	–	
Fall Time	t _f		–	11	–	
Turn-on Energy	E _{ON}		–	557	–	μJ
Turn-off Energy	E _{OFF}		–	44	–	
Total Switching Energy	E _{TOTAL}		–	601	–	

UFB25SC12E1BC3N

ELECTRICAL CHARACTERISTICS ($T_J = +25\text{ }^\circ\text{C}$ unless otherwise specified) (continued)

Parameter	Symbol	Test Conditions	Min	Typ	Max	Unit	
TYPICAL PERFORMANCE - DYNAMIC							
Turn-on Delay Time	$t_{d(on)}$	$V_{DS} = 800\text{ V}$, $I_D = 25\text{ A}$, Gate Driver = -5 V to $+15\text{ V}$, $R_{G_ON} = 22\text{ }\Omega$, $R_{G_OFF} = 22\text{ }\Omega$, Inductive Load, FWD: same device with $V_{GS} = 0\text{ V}$ and $R_G = 22\text{ }\Omega$, $T_J = 150\text{ }^\circ\text{C}$ (Notes 3, 4)	-	50	-	ns	
Rise Time	t_r		-	12	-		
Turn-off Delay Time	$t_{d(off)}$		-	55	-		
Fall Time	t_f		-	11	-		
Turn-on Energy	E_{ON}		-	516	-		μJ
Turn-off Energy	E_{OFF}		-	44	-		
Total Switching Energy	E_{TOTAL}		-	560	-		
Turn-on Delay Time	$t_{d(on)}$	$V_{DS} = 800\text{ V}$, $I_D = 25\text{ A}$, Gate Driver = -5 V to $+15\text{ V}$, Turn-on $R_{G,EXT} = 15\text{ }\Omega$, Turn-off $R_{G,EXT} = 10\text{ }\Omega$ Inductive Load, FWD: same device with $V_{GS} = 0\text{ V}$, and $R_G = 10\text{ }\Omega$, RC snubber: $R_S = 10\text{ }\Omega$, and $C_S = 100\text{ pF}$, $T_J = 25\text{ }^\circ\text{C}$ (Notes 5, 6)	-	52.8	-	ns	
Rise Time	t_r		-	22.4	-		
Turn-off Delay Time	$t_{d(off)}$		-	70	-		
Fall Time	t_f		-	16.8	-		
Turn-on Energy Including R_S Energy	E_{ON}		-	511	-	μJ	
Turn-off Energy Including R_S Energy	E_{OFF}		-	127	-		
Total Switching Energy	E_{TOTAL}		-	638	-		
Snubber R_S Energy During Turn-on	E_{RS_ON}		-	3	-		
Snubber R_S Energy During Turn-off	E_{RS_OFF}		-	3	-		
Turn-on Delay Time	$t_{d(on)}$		$V_{DS} = 800\text{ V}$, $I_D = 25\text{ A}$, Gate Driver = -5 V to $+15\text{ V}$, Turn-on $R_{G,EXT} = 15\text{ }\Omega$, Turn-off $R_{G,EXT} = 10\text{ }\Omega$ Inductive Load, FWD: same device with $V_{GS} = 0\text{ V}$, and $R_G = 10\text{ }\Omega$, RC snubber: $R_S = 10\text{ }\Omega$, and $C_S = 100\text{ pF}$, $T_J = 150\text{ }^\circ\text{C}$ (Notes 5, 6)	-	47.2		-
Rise Time	t_r	-		26.4	-		
Turn-off Delay Time	$t_{d(off)}$	-		73	-		
Fall Time	t_f	-		17	-		
Turn-on Energy Including R_S Energy	E_{ON}	-		484	-	μJ	
Turn-off Energy Including R_S Energy	E_{OFF}	-		126	-		
Total Switching Energy	E_{TOTAL}	-		610	-		
Snubber R_S Energy During Turn-on	E_{RS_ON}	-		2.8	-		
Snubber R_S Energy During Turn-off	E_{RS_OFF}	-		3.2	-		

Product parametric performance is indicated in the Electrical Characteristics for the listed test conditions, unless otherwise noted. Product performance may not be indicated by the Electrical Characteristics if operated under different conditions.

- Measured with the half-bridge mode switching test circuit in Figure 23.
- A bus RC snubber ($R_{BS} = 2.5\text{ }\Omega$, $C_{BS} = 200\text{ nF}$) must be applied to reduce the power loop high frequency oscillations.
- Measured with the half-bridge mode switching test circuit in Figure 24.
- In this table, the switching energies (turn-on energy, turn-off energy and total energy) presented include the device RC snubber energy losses.

UFB25SC12E1BC3N

SIC FET TYPICAL PERFORMANCE DIAGRAMS

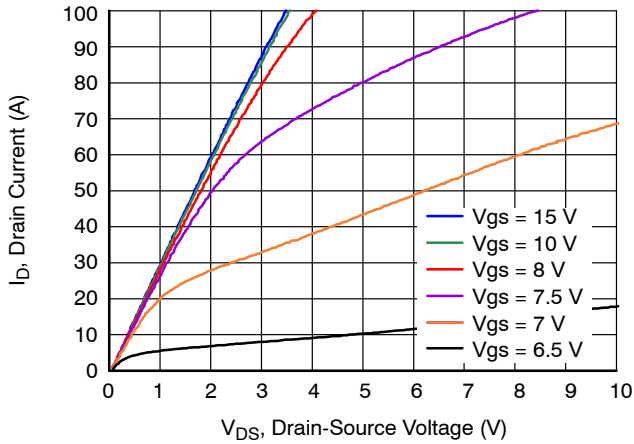

Figure 1. Typical Output Characteristics
at $T_J = -55\text{ }^\circ\text{C}$, $t_p < 250\text{ }\mu\text{s}$

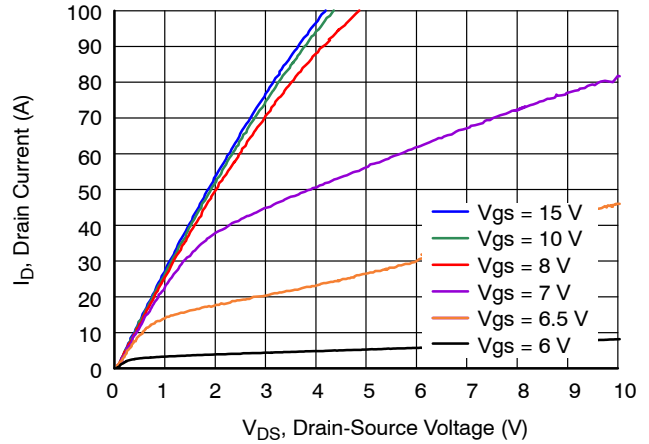

Figure 2. Typical Output Characteristics
at $T_J = 25\text{ }^\circ\text{C}$, $t_p < 250\text{ }\mu\text{s}$

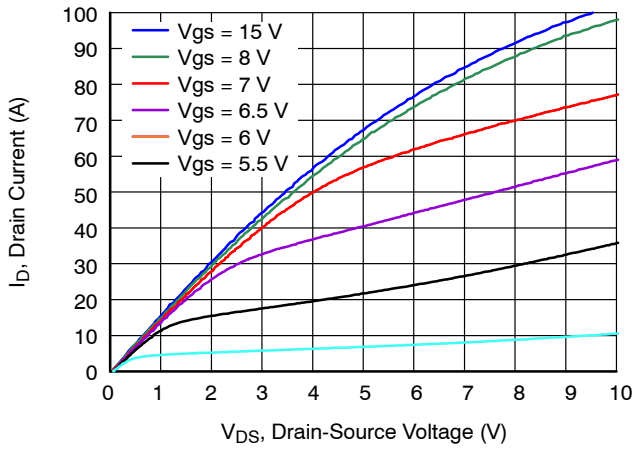

Figure 3. Typical Output Characteristics
at $T_J = 150\text{ }^\circ\text{C}$, $t_p < 250\text{ }\mu\text{s}$

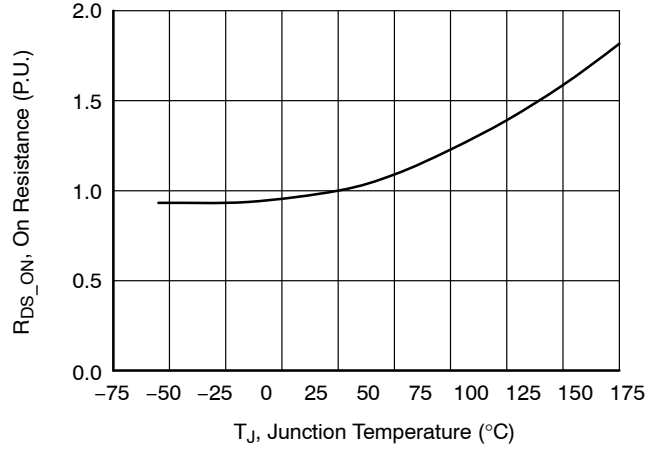

Figure 4. Normalized On-Resistance
vs. Temperature at $V_{GS} = 12\text{ V}$ and $I_D = 25\text{ A}$

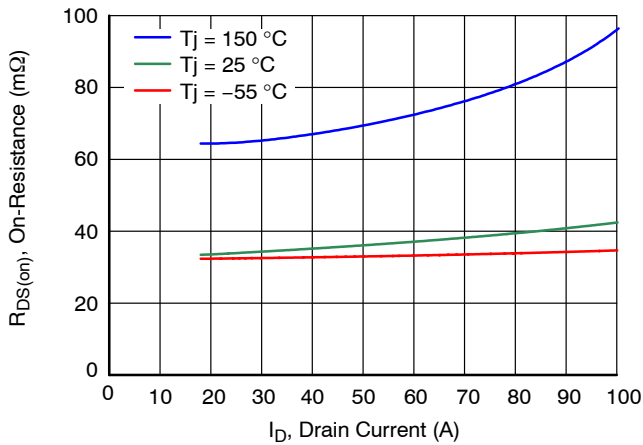

Figure 5. Typical Drain-Source On-Resistances
at $V_{GS} = 12\text{ V}$

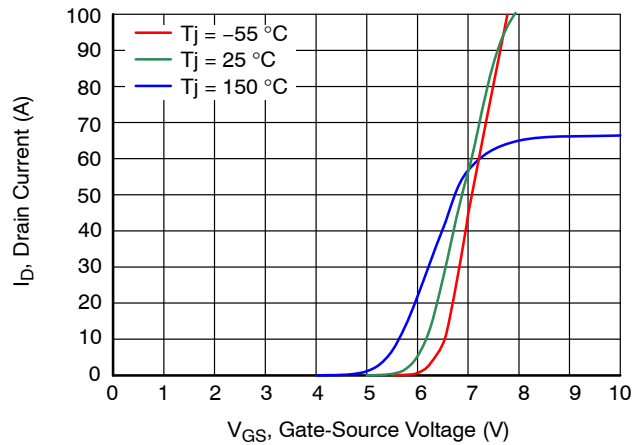

Figure 6. Typical Transfer Characteristics
at $V_{DS} = 5\text{ V}$

UFB25SC12E1BC3N

SiC FET TYPICAL PERFORMANCE DIAGRAMS (continued)

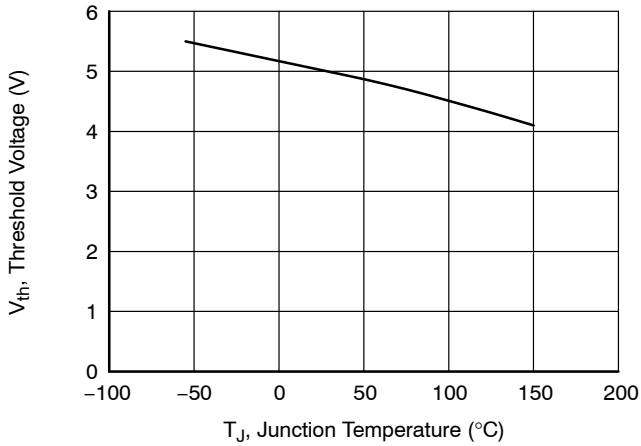

Figure 7. Threshold Voltage vs. Junction Temperature at $V_{DS} = 5\text{ V}$ and $I_D = 10\text{ mA}$

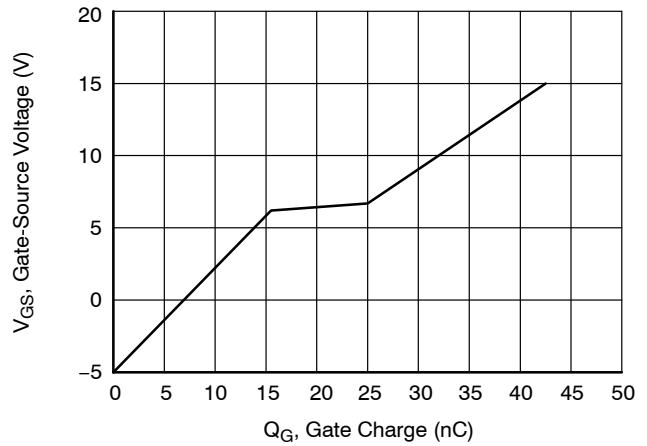

Figure 8. Typical Gate Charge at $V_{DS} = 800\text{ V}$ and $I_D = 25\text{ A}$

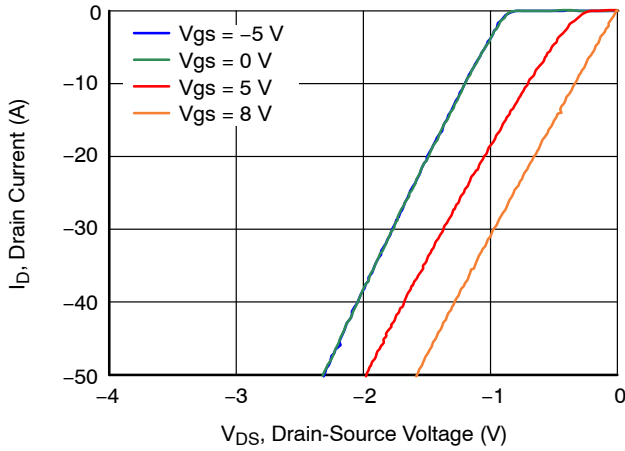

Figure 9. 3rd Quadrant Characteristics at $T_J = -55\text{ °C}$

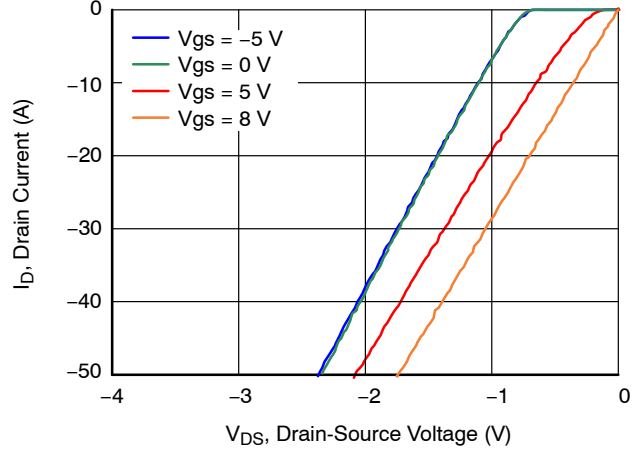

Figure 10. 3rd Quadrant Characteristics at $T_J = 25\text{ °C}$

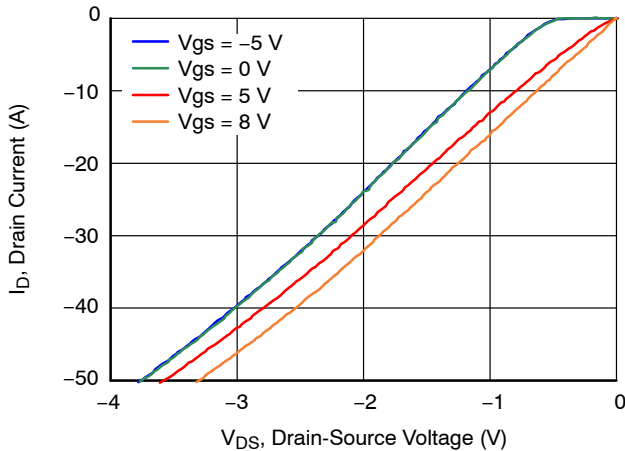

Figure 11. 3rd Quadrant Characteristics at $T_J = 150\text{ °C}$

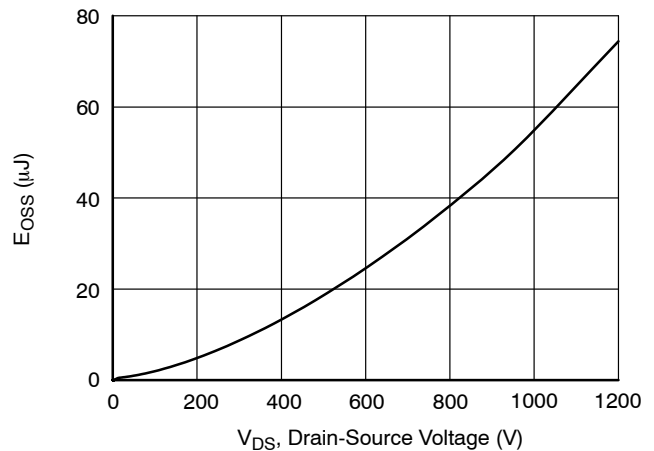

Figure 12. Typical Stored Energy in C_{OSS} at $V_{GS} = 0\text{ V}$

UFB25SC12E1BC3N

SiC FET TYPICAL PERFORMANCE DIAGRAMS (continued)

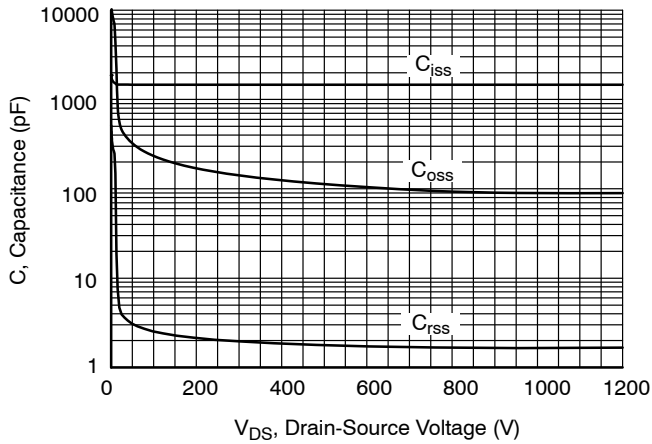

Figure 13. Typical Capacitances at $f = 100 \text{ kHz}$ and $V_{GS} = 0 \text{ V}$

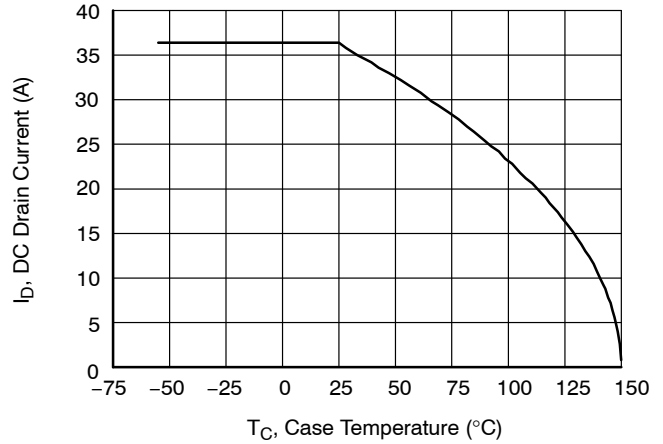

Figure 14. DC Drain Current Derating

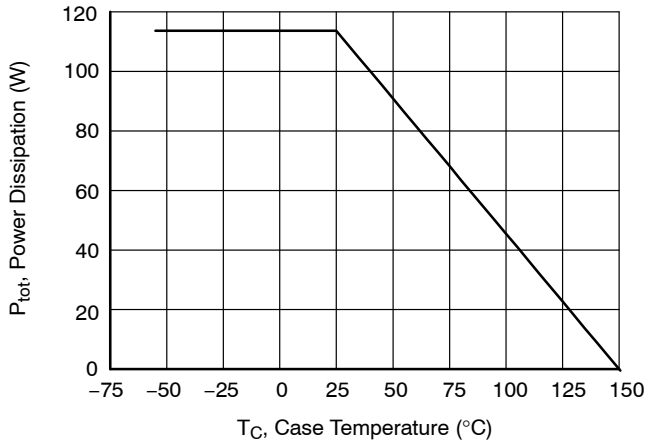

Figure 15. Total Power Dissipation

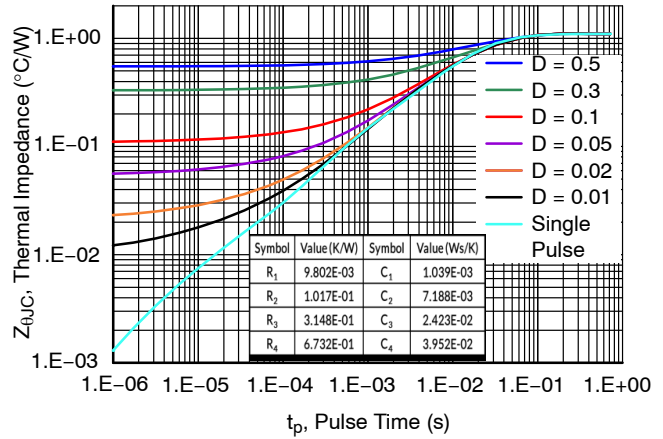

Figure 16. Maximum Transient Thermal Impedance and Parameters for Thermal Equivalent Circuit (Foster) Model

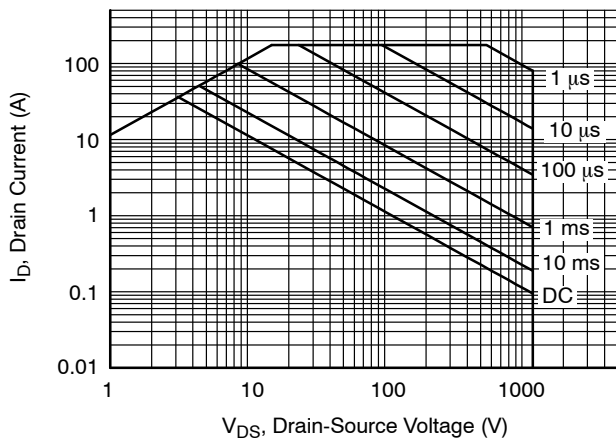

Figure 17. Safe Operation Area at $T_C = 25 \text{ }^\circ\text{C}$, $D = 0$, Parameter t_p

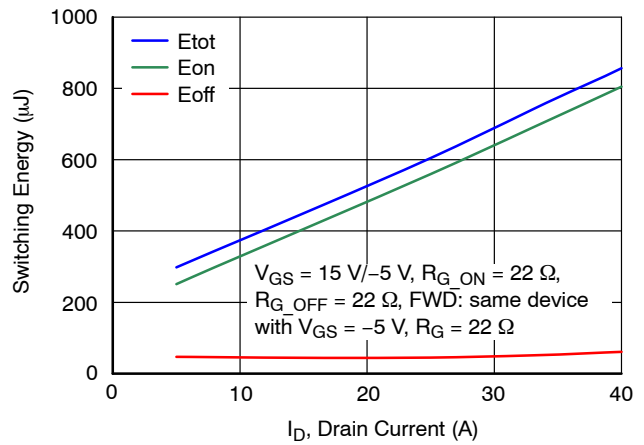

Figure 18. Clamped Inductive Switching Energy vs. Drain Current at $V_{DS} = 800 \text{ V}$ and $T_J = 25 \text{ }^\circ\text{C}$

UFB25SC12E1BC3N

SiC FET TYPICAL PERFORMANCE DIAGRAMS (continued)

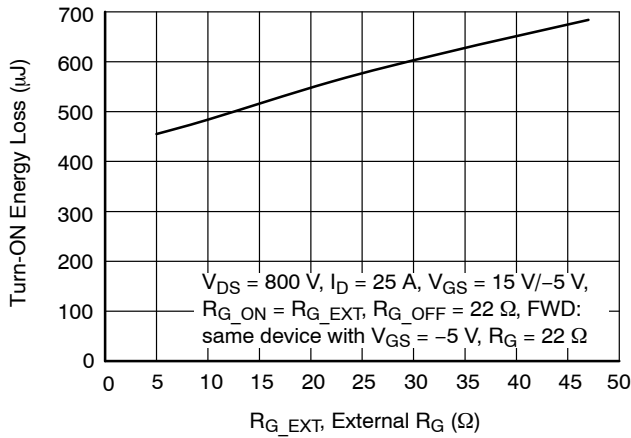

Figure 19. Clamped Inductive Switching Turn-On Energy vs. Turn-On Gate Resistance R_G at $T_J = 25^\circ\text{C}$

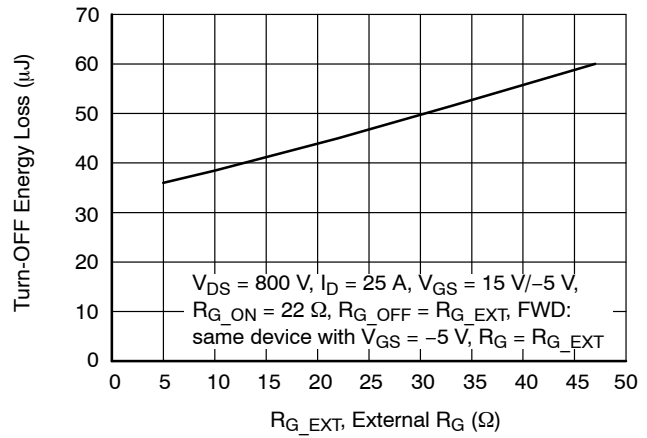

Figure 20. Clamped Inductive Switching Turn-Off Energy vs. Turn-Off Gate Resistance R_G at $T_J = 25^\circ\text{C}$

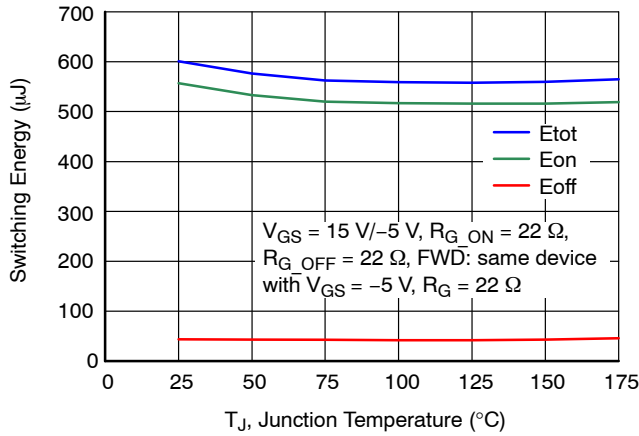

Figure 21. Clamped Inductive Switching Energy vs. Junction Temperature at $V_{DS} = 800\text{ V}$ and $I_D = 25\text{ A}$

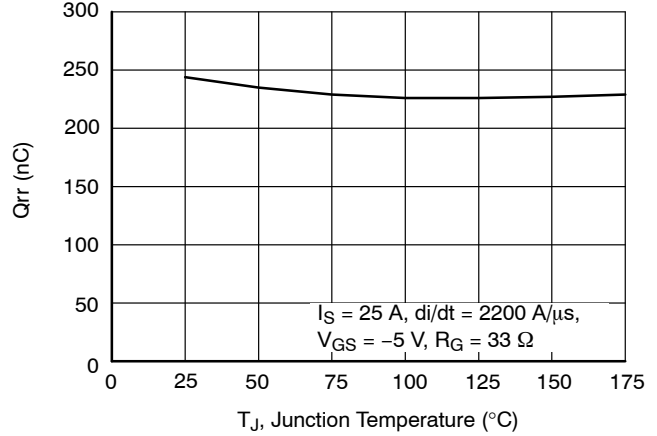

Figure 22. Reverse Recovery Charge Q_{rr} vs. Junction Temperature at $V_{DS} = 800\text{ V}$

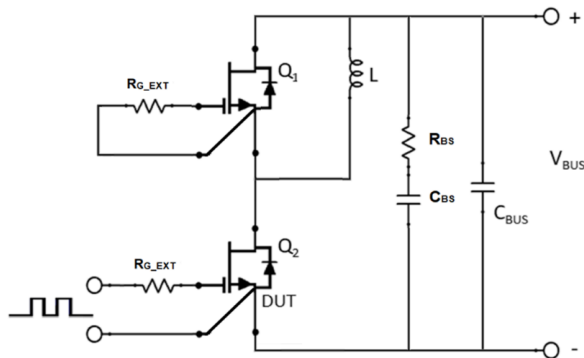

Figure 23. Schematic of the Half-bridge Mode Switching Test Circuit. Note, a Bus RC Snubber ($R_{BS} = 2.5\ \Omega$, $C_{BS} = 200\text{ nF}$) Must be Applied to Reduce the Power Loop High Frequency Oscillations

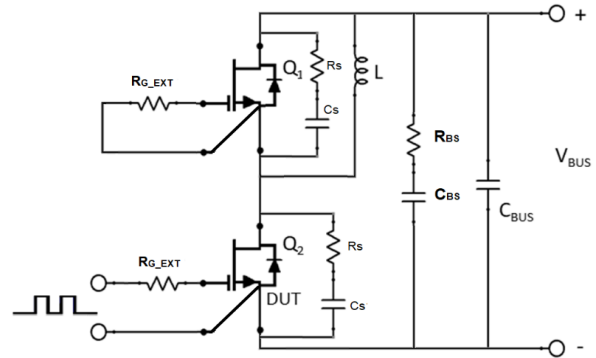

Figure 24. Schematic of the Half-bridge Mode Switching Test Circuit with Device RC Snubbers ($R_S = 10\ \Omega$, $C_S = 100\text{ pF}$) and a Bus RC Snubber ($R_{BS} = 2.5\ \Omega$, $C_{BS} = 200\text{ nF}$)

UFB25SC12E1BC3N

IMPORTANT MOUNTING INFORMATION

This product is recommended for use with solder pin attach and phase change thermal interface materials, and not recommended for implementations using press

fit and application of thermal grease. Please refer to mounting guidelines and user guide documents associated with this product for detailed information.

APPLICATIONS INFORMATION

SiC FETs are enhancement-mode power switches formed by a high-voltage SiC depletion-mode JFET and a low-voltage silicon MOSFET connected in series. The silicon MOSFET serves as the control unit while the SiC JFET provides high voltage blocking in the off state. This combination of devices in a single package provides compatibility with standard gate drivers and offers superior performance in terms of low on-resistance ($R_{DS(on)}$), output capacitance (C_{oss}), gate charge (Q_G), and reverse recovery charge (Q_{rr}) leading to low conduction and switching losses. The SiC FETs also provide excellent reverse conduction capability eliminating the need for an external anti-parallel diode.

Like other high performance power switches, proper PCB layout design to minimize circuit parasitics is strongly recommended due to the high dv/dt and di/dt rates. An external gate resistor is recommended when the FET is

working in the diode mode in order to achieve the optimum reverse recovery performance. For more information on SiC FET operation, see www.onsemi.com.

A snubber circuit with a small $R_{(G)}$, or gate resistor, provides better EMI suppression with higher efficiency compared to using a high $R_{(G)}$ value. There is no extra gate delay time when using the snubber circuitry, and a small $R_{(G)}$ will better control both the turn-off $V_{(DS)}$ peak spike and ringing duration, while a high $R_{(G)}$ will damp the peak spike but result in a longer delay time. In addition, the total switching loss when using a snubber circuit is less than using high $R_{(G)}$, while greatly reducing $E_{(OFF)}$ from mid-to-full load range with only a small increase in $E_{(ON)}$. Efficiency will therefore improve with higher load current. For more information on how a snubber circuit will improve overall system performance, visit the **onsemi** website at www.onsemi.com.

ORDERING INFORMATION

Part Number	Marking	Package	Shipping
UFB25SC12E1BC3N	UFB25SC12E1BC3N	PIM20 33.80x42.50x12.00 E1B FULL BRIDGE (SOLDER PIN) (Pb-Free, Halogen Free)	24 Units / Tray Blister

UFB25SC12E1BC3N

REVISION HISTORY

Revision	Description of Changes	Date
D	Acquired the original Qorvo JFET Division Data Sheet and updated the main document title to comply with onsemi standards for SiC products.	3/19/2025
4	Converted the Data Sheet to onsemi format.	6/4/2025

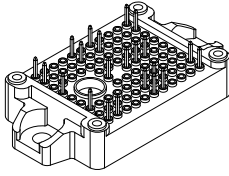

PIM20 33.80x42.50x12.00 E1B FULL BRIDGE (SOLDER PIN)
CASE 180DG
ISSUE O

DATE 21 MAR 2025

NOTES:

1. CONTROLLING DIMENSION: MILLIMETERS
2. PIN POSITION TOLERANCIS $\pm 0.40\text{mm}$

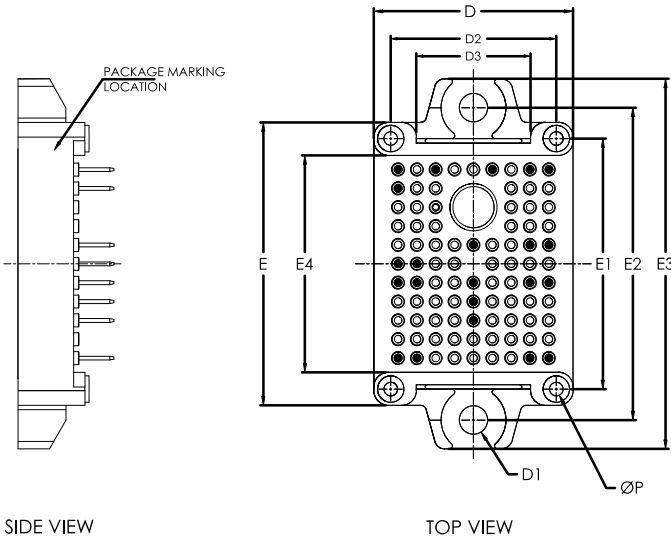

DIM	MILLIMETERS		
	MIN	NOM	MAX
A	11.65	12.00	12.35
A1	15.75	16.25	16.75
A2	0.15	0.50	0.85
b	0.59	0.64	0.69
D	33.50	33.80	34.10
D1	Ø4.7	Ø4.8	Ø4.9
D2	27.90	28.10	28.30
D3	19.20	19.40	19.60
E	47.70	48.00	48.30
E1	42.30	42.50	42.70
E2	52.90	53.00	53.10
E3	62.30	62.80	63.30
E4	36.60	36.80	37.00
P	Ø2.2	Ø2.3	Ø2.4

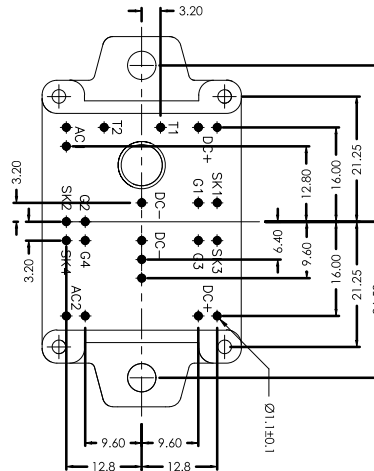
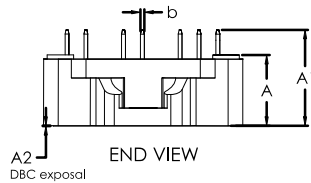
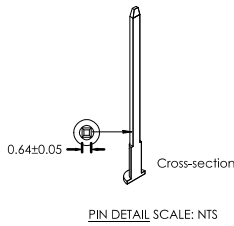

DOCUMENT NUMBER:	98AON67239H	Electronic versions are uncontrolled except when accessed directly from the Document Repository. Printed versions are uncontrolled except when stamped "CONTROLLED COPY" in red.
DESCRIPTION:	PIM20 33.80x42.50x12.00 E1B FULL BRIDGE (SOLDER PIN)	PAGE 1 OF 1

onsemi and onsemi are trademarks of Semiconductor Components Industries, LLC dba onsemi or its subsidiaries in the United States and/or other countries. onsemi reserves the right to make changes without further notice to any products herein. onsemi makes no warranty, representation or guarantee regarding the suitability of its products for any particular purpose, nor does onsemi assume any liability arising out of the application or use of any product or circuit, and specifically disclaims any and all liability, including without limitation special, consequential or incidental damages. onsemi does not convey any license under its patent rights nor the rights of others.

onsemi, **Onsemi**, and other names, marks, and brands are registered and/or common law trademarks of Semiconductor Components Industries, LLC dba "**onsemi**" or its affiliates and/or subsidiaries in the United States and/or other countries. **onsemi** owns the rights to a number of patents, trademarks, copyrights, trade secrets, and other intellectual property. A listing of **onsemi**'s product/patent coverage may be accessed at www.onsemi.com/site/pdf/Patent-Marking.pdf. **onsemi** reserves the right to make changes at any time to any products or information herein, without notice. The information herein is provided "as-is" and **onsemi** makes no warranty, representation or guarantee regarding the accuracy of the information, product features, availability, functionality, or suitability of its products for any particular purpose, nor does **onsemi** assume any liability arising out of the application or use of any product or circuit, and specifically disclaims any and all liability, including without limitation special, consequential or incidental damages. Buyer is responsible for its products and applications using **onsemi** products, including compliance with all laws, regulations and safety requirements or standards, regardless of any support or applications information provided by **onsemi**. "Typical" parameters which may be provided in **onsemi** data sheets and/or specifications can and do vary in different applications and actual performance may vary over time. All operating parameters, including "Typicals" must be validated for each customer application by customer's technical experts. **onsemi** does not convey any license under any of its intellectual property rights nor the rights of others. **onsemi** products are not designed, intended, or authorized for use as a critical component in life support systems or any FDA Class 3 medical devices or medical devices with a same or similar classification in a foreign jurisdiction or any devices intended for implantation in the human body. Should Buyer purchase or use **onsemi** products for any such unintended or unauthorized application, Buyer shall indemnify and hold **onsemi** and its officers, employees, subsidiaries, affiliates, and distributors harmless against all claims, costs, damages, and expenses, and reasonable attorney fees arising out of, directly or indirectly, any claim of personal injury or death associated with such unintended or unauthorized use, even if such claim alleges that **onsemi** was negligent regarding the design or manufacture of the part. **onsemi** is an Equal Opportunity/Affirmative Action Employer. This literature is subject to all applicable copyright laws and is not for resale in any manner.

ADDITIONAL INFORMATION

TECHNICAL PUBLICATIONS:

Technical Library: www.onsemi.com/design/resources/technical-documentation
onsemi Website: www.onsemi.com

ONLINE SUPPORT: www.onsemi.com/support

For additional information, please contact your local Sales Representative at www.onsemi.com/support/sales