

Silicon Carbide (SiC) Cascode JFET - EliteSiC, Power N-Channel, TO247-3, 1200 V, 80 mohm

UF3C120080K3S

Description

This SiC FET device is based on a unique ‘cascode’ circuit configuration, in which a normally-on SiC JFET is co-packaged with a Si MOSFET to produce a normally-off SiC FET device. The device’s standard gate-drive characteristics allows for a true “drop-in replacement” to Si IGBTs, Si FETs, SiC MOSFETs or Si super-junction devices. Available in the TO247-3 package, this device exhibits ultralow gate charge and exceptional reverse recovery characteristics, making it ideal for switching inductive loads when used with recommended RC-snubbers, and any application requiring standard gate drive.

Features

- Typical On-resistance $R_{DS(on),typ}$ of 80 mΩ
- Maximum Operating Temperature of 175 °C
- Excellent Reverse Recovery
- Low Gate Charge
- Low Intrinsic Capacitance
- ESD Protected, HBM Class 2
- Very Low Switching Losses (required RC-snubber loss negligible under typical operating conditions)
- This Device is Pb-Free, Halogen Free and is RoHS Compliant

Typical Applications

- EV Charging
- PV Inverters
- Switch Mode Power Supplies
- Power Factor Correction Modules
- Motor Drives
- Induction Heating

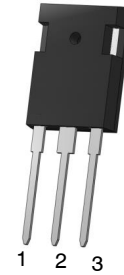

TO247-3
CASE 340AK

MARKING DIAGRAM

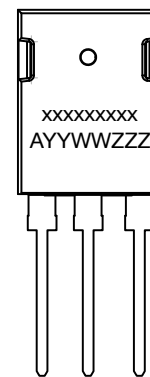

XXXXXXXX = Specific Device Number
A = Assembly Location
YY = Year
WW = Work Week
ZZZ = Lot ID

PIN CONNECTIONS

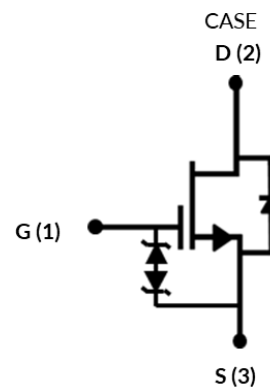

ORDERING INFORMATION

See detailed ordering and shipping information on page 9 of this data sheet.

UF3C120080K3S

MAXIMUM RATINGS

Parameter	Symbol	Test Conditions	Value	Unit
Drain-source Voltage	V_{DS}		1200	V
Gate-source Voltage	V_{GS}	DC	-25 to +25	V
Continuous Drain Current (Note 1)	I_D	$T_C = 25\text{ }^\circ\text{C}$	33	A
		$T_C = 100\text{ }^\circ\text{C}$	24	A
Pulsed Drain Current (Note 2)	I_{DM}	$T_C = 25\text{ }^\circ\text{C}$	77	A
Single Pulsed Avalanche Energy (Note 3)	E_{AS}	$L = 15\text{ mH}, I_{AS} = 2.8\text{ A}$	58.5	mJ
Power Dissipation	P_{tot}	$T_C = 25\text{ }^\circ\text{C}$	254.2	W
Maximum Junction Temperature	$T_{J,max}$		175	$^\circ\text{C}$
Operating and Storage Temperature	T_J, T_{STG}		-55 to 175	$^\circ\text{C}$
Max. Lead Temperature for Soldering, 1/8" from Case for 5 Seconds	T_L		250	$^\circ\text{C}$

Stresses exceeding those listed in the Maximum Ratings table may damage the device. If any of these limits are exceeded, device functionality should not be assumed, damage may occur and reliability may be affected.

- Limited by $T_{J,max}$
- Pulse width t_p limited by $T_{J,max}$
- Starting $T_J = 25\text{ }^\circ\text{C}$

THERMAL CHARACTERISTICS

Parameter	Symbol	Test Conditions	Min	Typ	Max	Unit
Thermal Resistance, Junction-to-Case	$R_{\theta JC}$		-	0.45	0.59	$^\circ\text{C/W}$

ELECTRICAL CHARACTERISTICS ($T_J = +25\text{ }^\circ\text{C}$ unless otherwise specified)

Parameter	Symbol	Test Conditions	Min	Typ	Max	Unit
-----------	--------	-----------------	-----	-----	-----	------

TYPICAL PERFORMANCE – STATIC

Drain-source Breakdown Voltage	BV_{DS}	$V_{GS} = 0\text{ V}, I_D = 1\text{ mA}$	1200	-	-	V	
Total Drain Leakage Current	I_{DSS}	$V_{DS} = 1200\text{ V}, V_{GS} = 0\text{ V}, T_J = 25\text{ }^\circ\text{C}$	-	10	75	μA	
		$V_{DS} = 1200\text{ V}, V_{GS} = 0\text{ V}, T_J = 175\text{ }^\circ\text{C}$	-	50	-		
Total Gate Leakage Current	I_{GSS}	$V_{DS} = 0\text{ V}, T_J = 25\text{ }^\circ\text{C}, V_{GS} = -20\text{ V}/+20\text{ V}$	-	6	± 20	μA	
Drain-source On-resistance	$R_{DS(on)}$	$V_{GS} = 12\text{ V}, I_D = 20\text{ A}$	$T_J = 25\text{ }^\circ\text{C}$	-	80	100	m Ω
			$T_J = 125\text{ }^\circ\text{C}$	-	130	-	
			$T_J = 175\text{ }^\circ\text{C}$	-	172	-	
Gate Threshold Voltage	$V_{G(th)}$	$V_{DS} = 5\text{ V}, I_D = 10\text{ mA}$	4	5	6	V	
Gate Resistance	R_G	$f = 1\text{ MHz}, \text{open drain}$	-	4.5	-	Ω	

TYPICAL PERFORMANCE – REVERSE DIODE

Diode Continuous Forward Current (Note 4)	I_S	$T_C = 25\text{ }^\circ\text{C}$	-	-	33	A
Diode Pulse Current (Note 5)	$I_{S,pulse}$	$T_C = 25\text{ }^\circ\text{C}$	-	-	77	A
Forward Voltage	V_{FSD}	$V_{GS} = 0\text{ V}, I_S = 10\text{ A}, T_J = 25\text{ }^\circ\text{C}$	-	1.5	2	V
		$V_{GS} = 0\text{ V}, I_S = 10\text{ A}, T_J = 175\text{ }^\circ\text{C}$	-	2	-	
Reverse Recovery Charge	Q_{rr}	$V_{DS} = 800\text{ V}, I_S = 20\text{ A}, V_{GS} = -5\text{ V}, R_{G,EXT} = 10\text{ }\Omega, di/dt = 2300\text{ A}/\mu\text{s}, T_J = 25\text{ }^\circ\text{C}$	-	212	-	nC
Reverse Recovery Time	t_{rr}		-	23	-	ns
Reverse Recovery Charge	Q_{rr}	$V_{DS} = 800\text{ V}, I_S = 20\text{ A}, V_{GS} = -5\text{ V}, R_{G,EXT} = 10\text{ }\Omega, di/dt = 2300\text{ A}/\mu\text{s}, T_J = 150\text{ }^\circ\text{C}$	-	124	-	nC
Reverse Recovery Time	t_{rr}		-	13	-	ns

UF3C120080K3S

ELECTRICAL CHARACTERISTICS ($T_J = +25\text{ }^\circ\text{C}$ unless otherwise specified) (continued)

Parameter	Symbol	Test Conditions	Min	Typ	Max	Unit	
TYPICAL PERFORMANCE – DYNAMIC							
Input Capacitance	C_{iss}	$V_{DS} = 100\text{ V}, V_{GS} = 0\text{ V},$ $f = 100\text{ kHz}$	–	1500	–	pF	
Output Capacitance	C_{oss}		–	100	–		
Reverse Transfer Capacitance	C_{rss}		–	2.1	–		
Effective Output Capacitance, Energy Related	$C_{oss(er)}$	$V_{DS} = 0\text{ V to }800\text{ V}, V_{GS} = 0\text{ V}$	–	59	–	pF	
Effective Output Capacitance, Time Related	$C_{oss(tr)}$		–	136	–	pF	
C_{oss} Stored Energy	E_{oss}	$V_{DS} = 800\text{ V}, V_{GS} = 0\text{ V}$	–	19	–	μJ	
Total Gate Charge	Q_G	$V_{DS} = 800\text{ V}, I_D = 20\text{ A},$ $V_{GS} = -5\text{ V to }15\text{ V}$	–	51	–	nC	
Gate-drain Charge	Q_{GD}		–	11	–		
Gate-source Charge	Q_{GS}		–	19	–		
Turn-on Delay Time	$t_{d(on)}$	$V_{DS} = 800\text{ V}, I_D = 20\text{ A},$ Gate Driver = $-5\text{ V to }+15\text{ V},$ Turn-on $R_{G,EXT} = 1\ \Omega,$ Turn-off $R_{G,EXT} = 22\ \Omega,$ Inductive Load, FWD: Same Device With $V_{GS} = -5\text{ V}, R_G = 22\ \Omega,$ RC Snubber: $R_S = 5\ \Omega,$ $C_S = 150\text{ pF}, T_J = 25\text{ }^\circ\text{C}$	–	26	–	ns	
Rise Time	t_r		–	17	–		
Turn-off Delay Time	$t_{d(off)}$		–	57	–		
Fall Time	t_f		–	19	–		
Turn-on Energy Including R_S Energy (Note 6)	E_{ON}		–	500	–		μJ
Turn-off Energy Including R_S Energy (Note 6)	E_{OFF}		–	85	–		
Total Switching Energy Including R_S Energy (Note 6)	E_{TOTAL}		–	585	–		
Snubber R_S Energy During Turn-on	E_{RS_ON}		–	4.3	–		
Snubber R_S Energy During Turn-off	E_{RS_OFF}		–	3.8	–		
Turn-on Delay Time	$t_{d(on)}$		$V_{DS} = 800\text{ V}, I_D = 20\text{ A},$ Gate Driver = $-5\text{ V to }+15\text{ V},$ Turn-on $R_{G,EXT} = 1\ \Omega,$ Turn-off $R_{G,EXT} = 22\ \Omega,$ Inductive Load, FWD: Same Device With $V_{GS} = -5\text{ V}, R_G = 22\ \Omega,$ RC Snubber: $R_S = 5\ \Omega,$ $C_S = 150\text{ pF}, T_J = 150\text{ }^\circ\text{C}$	–	26		
Rise Time	t_r	–		16	–		
Turn-off Delay Time	$t_{d(off)}$	–		58	–		
Fall Time	t_f	–		19	–		
Turn-on Energy Including R_S Energy (Note 6)	E_{ON}	–		482	–	μJ	
Turn-off Energy Including R_S Energy (Note 6)	E_{OFF}	–		87	–		
Total Switching Energy Including R_S Energy (Note 6)	E_{TOTAL}	–		569	–		
Snubber R_S Energy During Turn-on	E_{RS_ON}	–		4.1	–		
Snubber R_S Energy During Turn-off	E_{RS_OFF}	–		3.8	–		

Product parametric performance is indicated in the Electrical Characteristics for the listed test conditions, unless otherwise noted. Product performance may not be indicated by the Electrical Characteristics if operated under different conditions.

4. Limited by $T_{J,max}$

5. Pulse width t_p limited by $T_{J,max}$

6. The switching performance are evaluated with a RC snubber circuit as shown in Figure 29.

TYPICAL PERFORMANCE DIAGRAMS

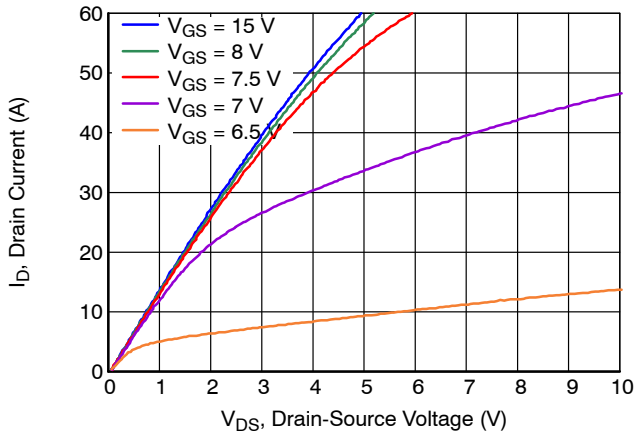

Figure 1. Typical Output Characteristics at $T_J = -55\text{ }^\circ\text{C}$, $t_p < 250\text{ }\mu\text{s}$

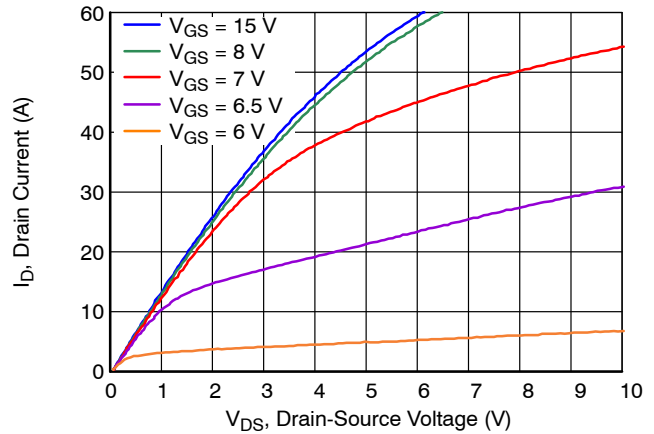

Figure 2. Typical Output Characteristics at $T_J = 25\text{ }^\circ\text{C}$, $t_p < 250\text{ }\mu\text{s}$

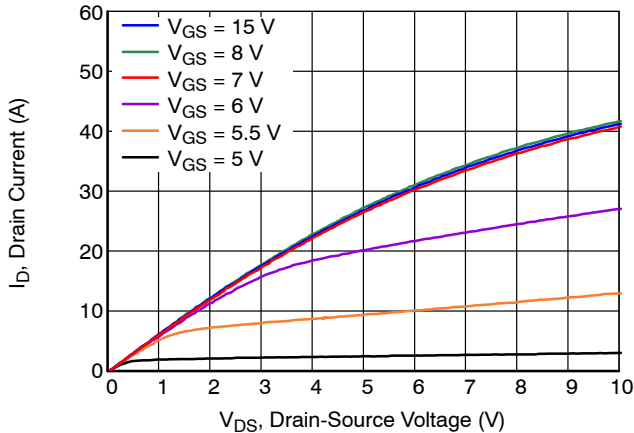

Figure 3. Typical Output Characteristics at $T_J = 175\text{ }^\circ\text{C}$, $t_p < 250\text{ }\mu\text{s}$

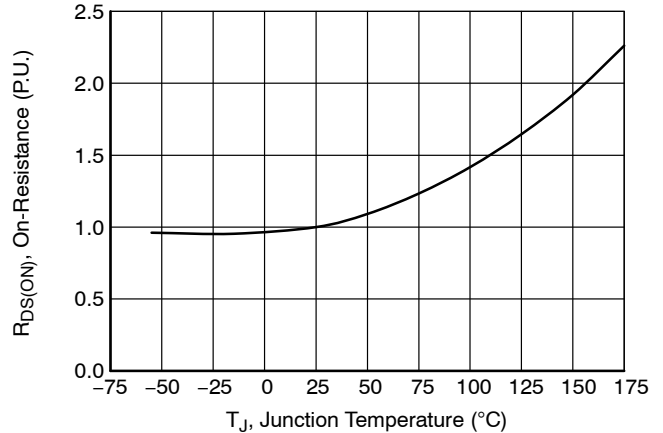

Figure 4. Normalized On-Resistance vs. Temperature at $V_{GS} = 12\text{ V}$ and $I_D = 20\text{ A}$

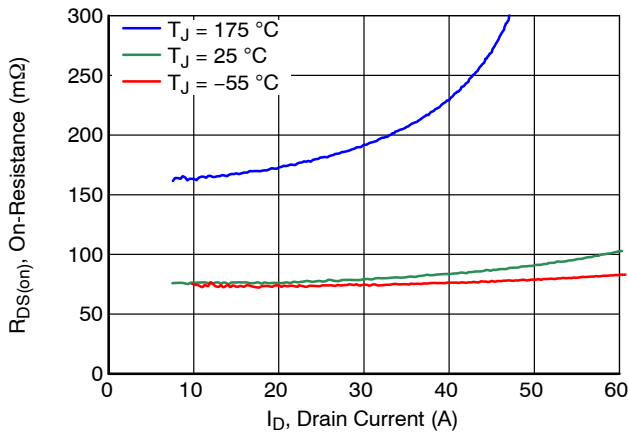

Figure 5. Typical Drain-Source On-Resistances at $V_{GS} = 12\text{ V}$

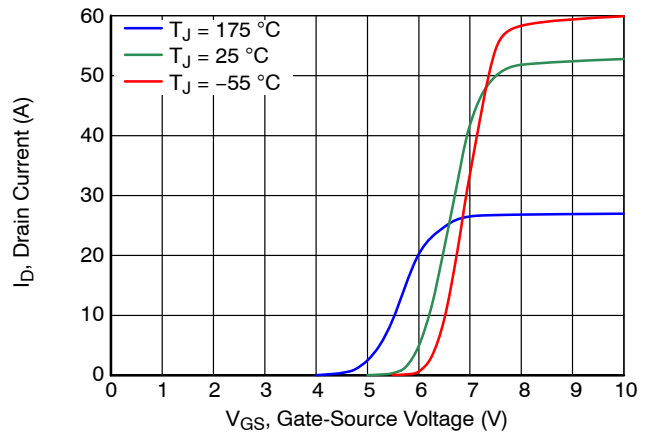

Figure 6. Typical Transfer Characteristics at $V_{DS} = 5\text{ V}$

TYPICAL PERFORMANCE DIAGRAMS (continued)

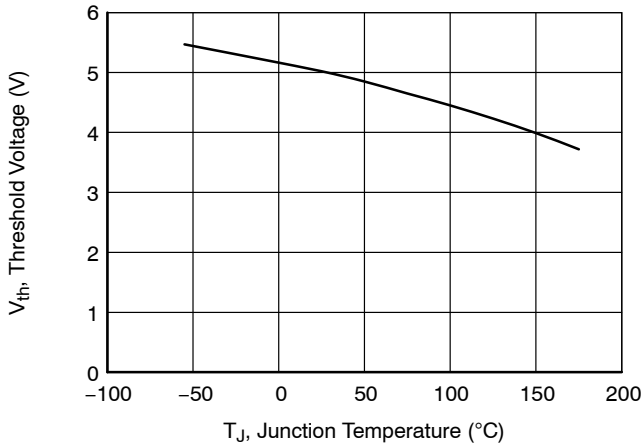

Figure 7. Threshold Voltage vs. Junction Temperature at $V_{DS} = 5\text{ V}$ and $I_D = 10\text{ mA}$

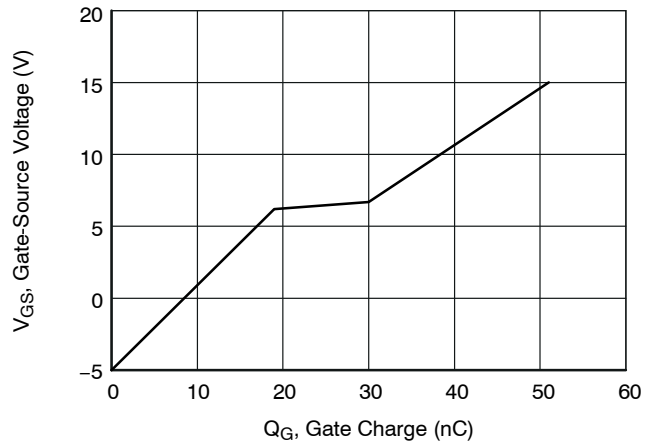

Figure 8. Typical Gate Charge at $V_{DS} = 800\text{ V}$ and $I_D = 20\text{ A}$

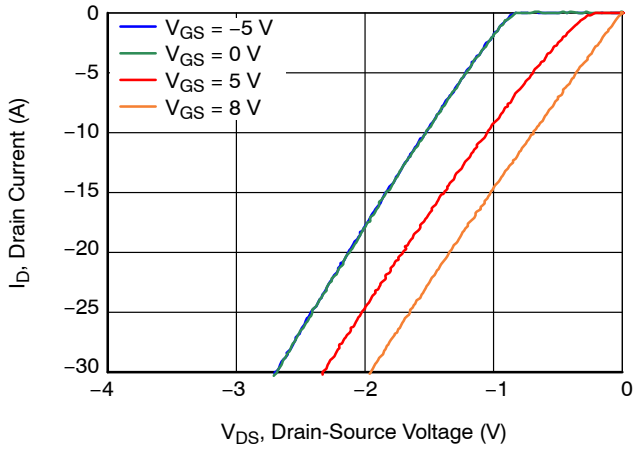

Figure 9. 3rd Quadrant Characteristics at $T_J = -55\text{ }^\circ\text{C}$

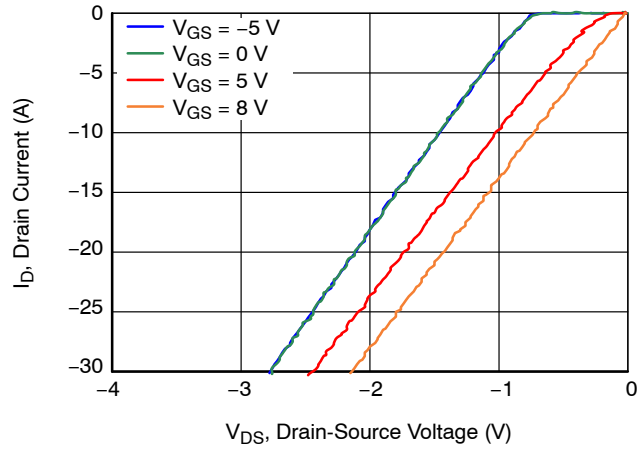

Figure 10. 3rd Quadrant Characteristics at $T_J = 25\text{ }^\circ\text{C}$

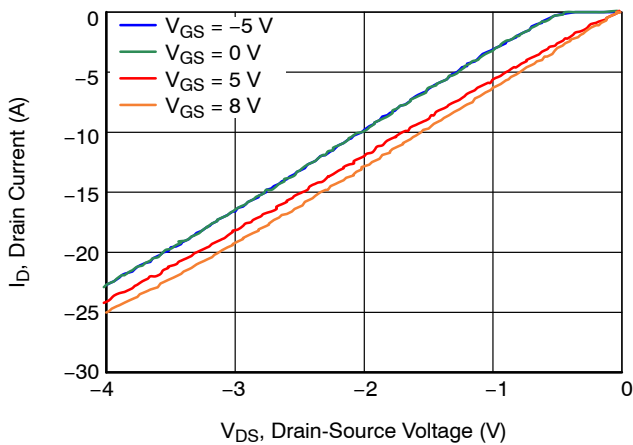

Figure 11. 3rd Quadrant Characteristics at $T_J = 175\text{ }^\circ\text{C}$

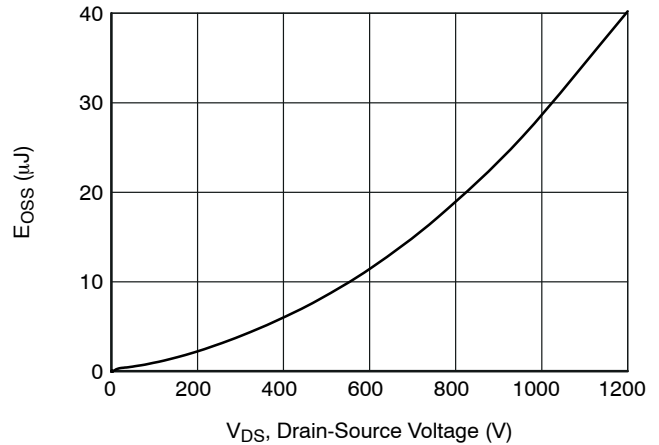

Figure 12. Typical Stored Energy in C_{OSS} at $V_{GS} = 0\text{ V}$

UF3C120080K3S

TYPICAL PERFORMANCE DIAGRAMS (continued)

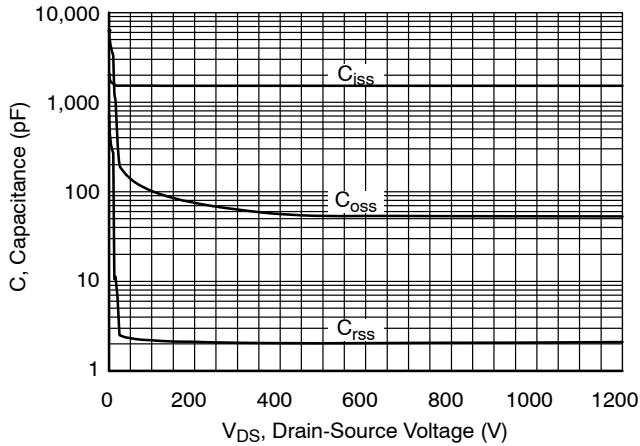

Figure 13. Typical Capacitances at $f = 100 \text{ kHz}$ and $V_{GS} = 0 \text{ V}$

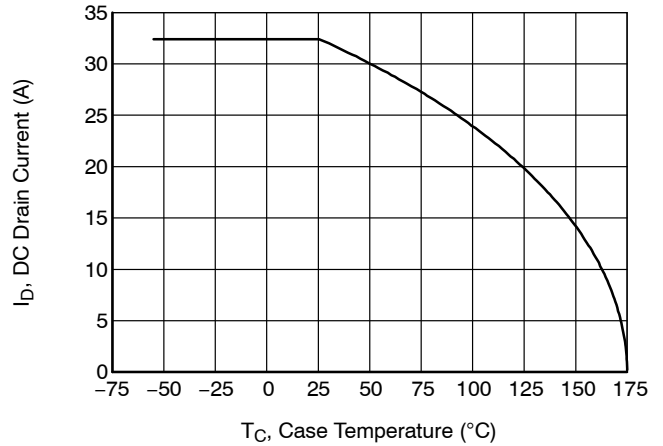

Figure 14. DC Drain Current Derating

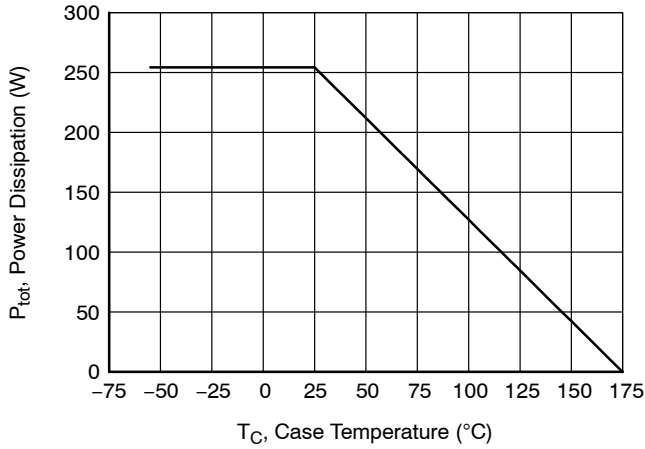

Figure 15. Total Power Dissipation

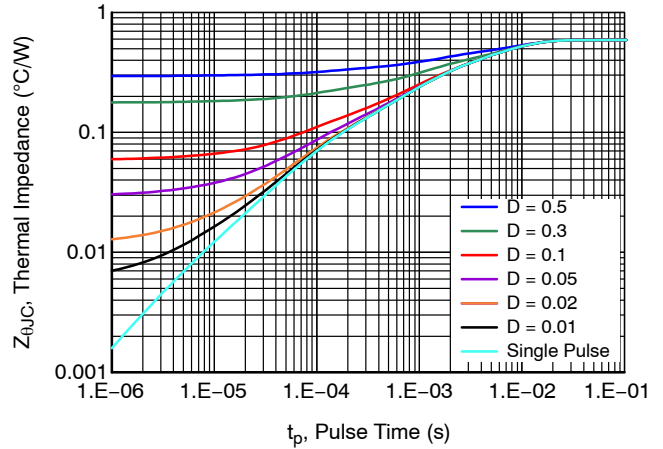

Figure 16. Maximum Transient Thermal Impedance

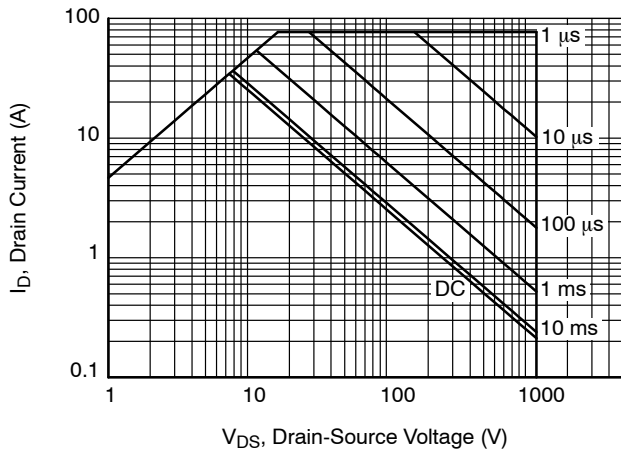

Figure 17. Safe Operation Area at $T_C = 25 \text{ }^\circ\text{C}$, $D = 0$, Parameter t_p

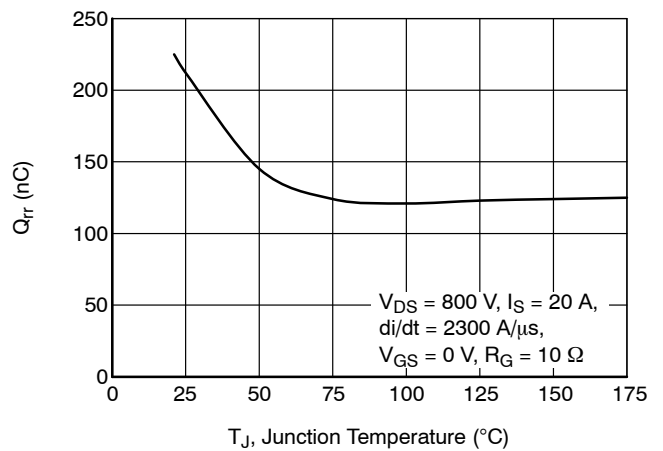

Figure 18. Reverse Recovery Charge Q_{rr} vs. Junction Temperature

TYPICAL PERFORMANCE DIAGRAMS (continued)

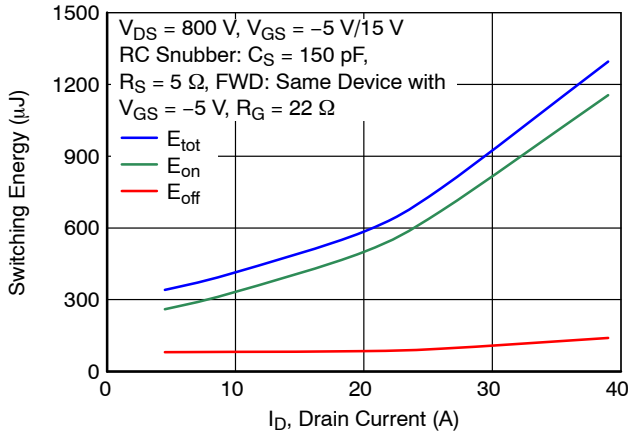

Figure 19. Clamped Inductive Switching Energy vs. Drain Current at $T_J = 25\text{ }^\circ\text{C}$, Turn-on $R_{G_EXT} = 1\ \Omega$, and Turn-off $R_{G_EXT} = 22\ \Omega$

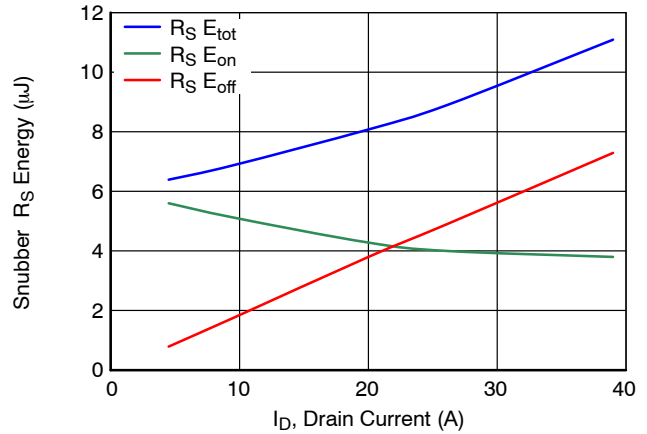

Figure 20. RC Snubber Energy Loss vs. Drain Current at the Test Conditions Shown in Figure 19

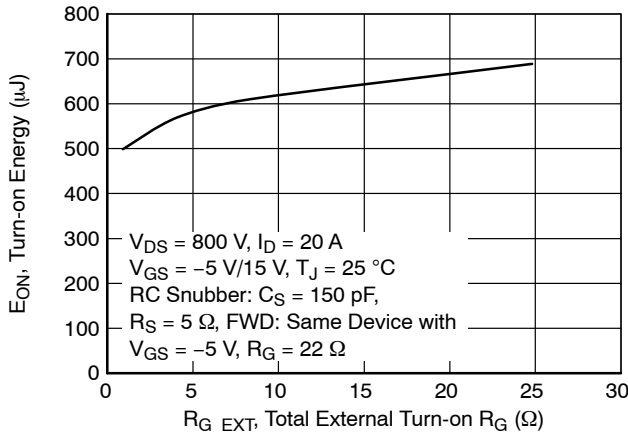

Figure 21. Clamped Inductive Switching Turn-on Energy Including RC Snubber Energy Loss as a Function of Total External Turn-on Gate Resistor R_{G_EXT}

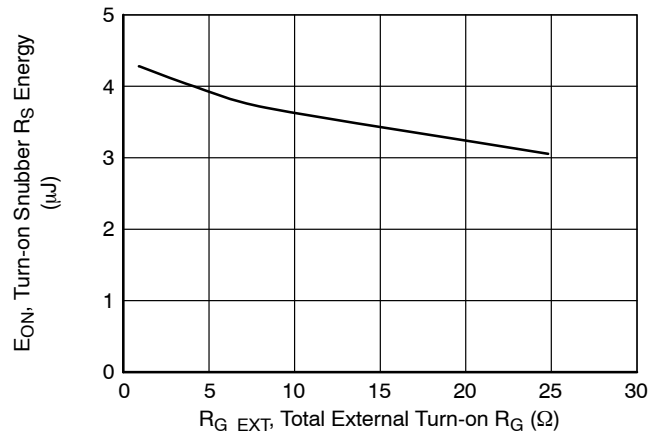

Figure 22. RC Snubber Energy Loss as a Function of Total External Turn-on Gate Resistor R_{G_EXT} at the Test Conditions Shown in Figure 21

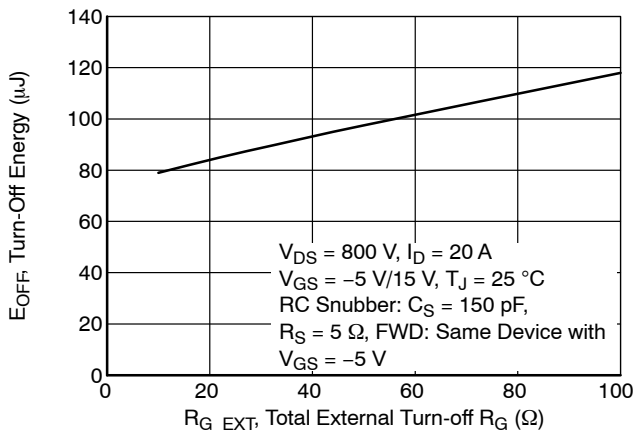

Figure 23. Clamped Inductive Switching Turn-off Energy Including RC Snubber Energy Loss as a Function of Total External Turn-off Gate Resistor R_{G_EXT}

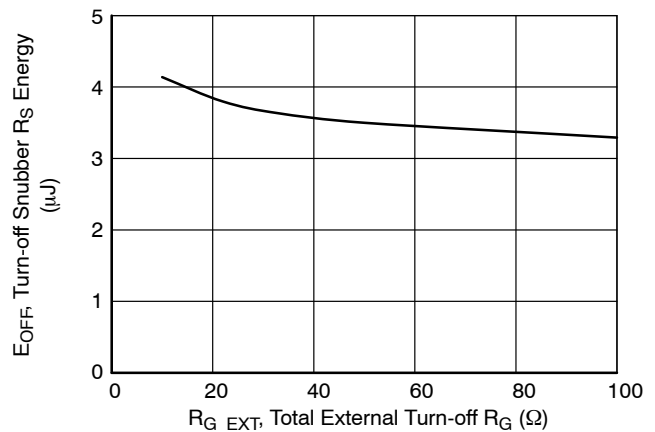

Figure 24. RC Snubber Energy Loss as a Function of Total External Turn-off Gate Resistor R_{G_EXT} at the Test Conditions Shown in Figure 23

TYPICAL PERFORMANCE DIAGRAMS (continued)

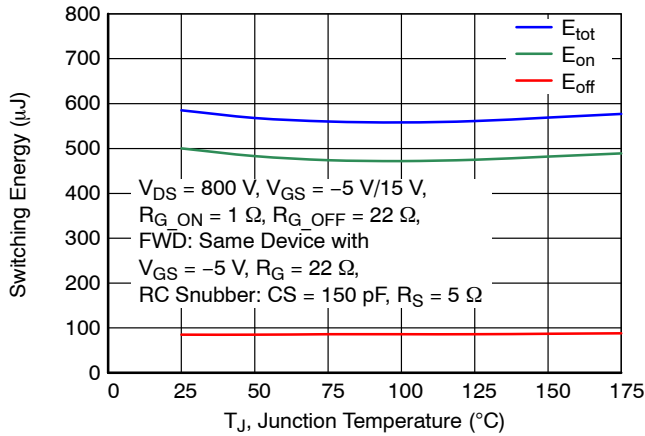

Figure 25. Clamped Inductive Switching Energy Including RC Snubber Energy Loss as a Function of Junction Temperature at $I_D = 20\text{ A}$

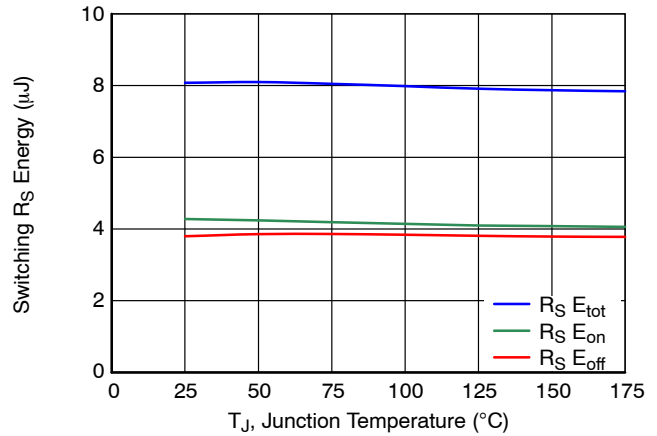

Figure 26. RC Snubber Energy Loss as a Function of Junction Temperature at the Test Conditions Shown in Figure 25

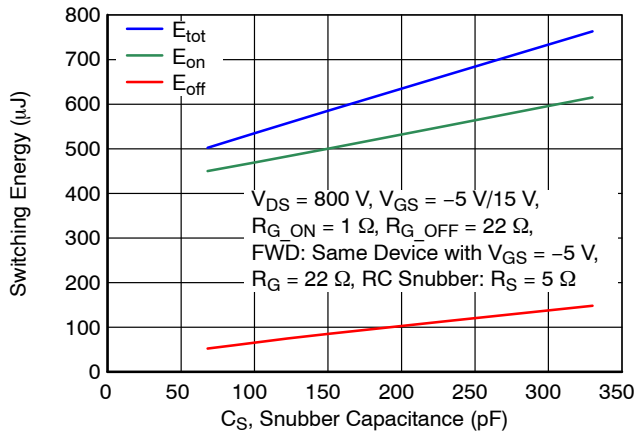

Figure 27. Clamped Inductive Switching Energy Including RC Snubber Energy Loss as a Function of Snubber Capacitance at $I_D = 20\text{ A}$ and $T_J = 25\text{ °C}$

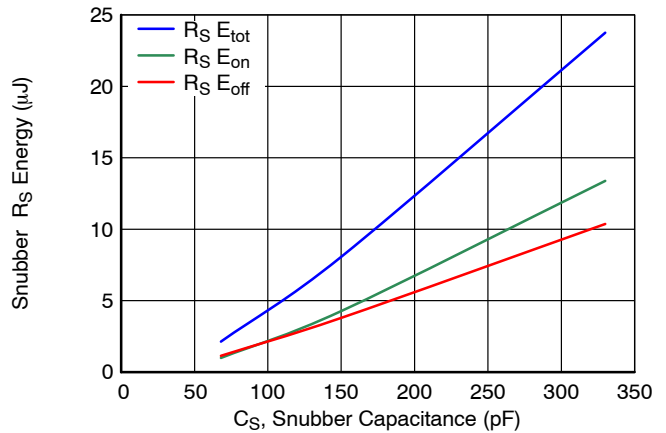

Figure 28. RC Snubber Energy Loss as a Function of Snubber Capacitance at the Test Conditions Shown in Figure 27

UF3C120080K3S

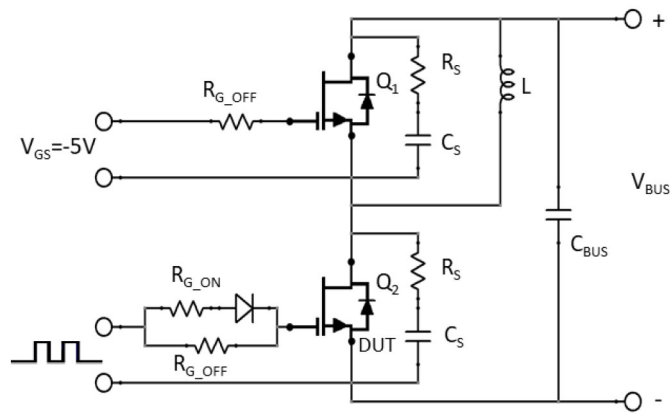

Figure 29. Clamped Inductive Load Switching Test Circuit An RC Snubber ($R_S = 5 \Omega$ and $C_S = 150 \text{ pF}$) is Required to Improve the Turn-off Waveforms

APPLICATIONS INFORMATION

SiC cascodes are enhancement-mode power switches formed by a high-voltage SiC depletion-mode JFET and a low-voltage silicon MOSFET connected in series. The silicon MOSFET serves as the control unit while the SiC JFET provides high voltage blocking in the off state. This combination of devices in a single package provides compatibility with standard gate drivers and offers superior performance in terms of low on-resistance ($R_{DS(on)}$), output capacitance (C_{oss}), gate charge (Q_g), and reverse recovery charge (Q_{rr}) leading to low conduction and switching losses. The SiC cascodes also provide excellent reverse conduction

capability eliminating the need for an external anti-parallel diode.

Like other high performance power switches, proper PCB layout design to minimize circuit parasitics is strongly recommended due to the high dv/dt and di/dt rates. An external gate resistor is recommended when the FET is working in the diode mode in order to achieve the optimum reverse recovery performance. For more information on SiC FET operation, see www.onsemi.com.

ORDERING INFORMATION

Part Number	Marking	Package	Shipping
UF3C120080K3S	UF3C120080K3S	TO247-3 (Pb-Free, Halogen Free)	600 / Tube

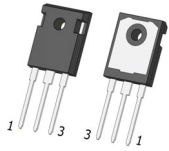

TO247-3 15.90x20.96x5.03, 5.44P
CASE 340AK
ISSUE B

DATE 14 APR 2025

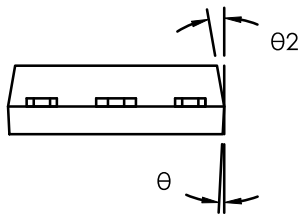
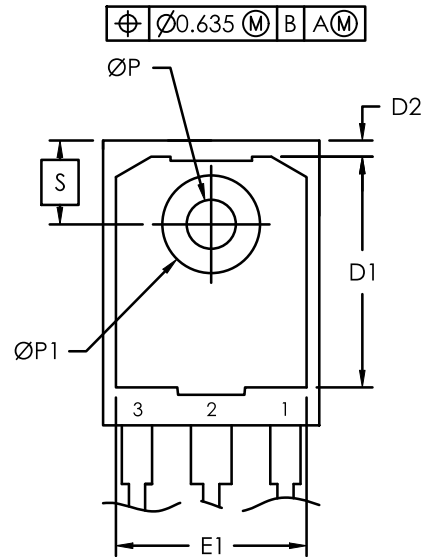
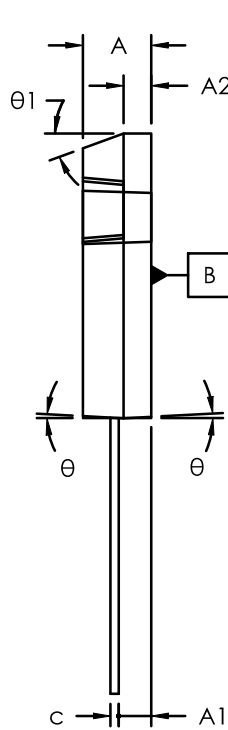
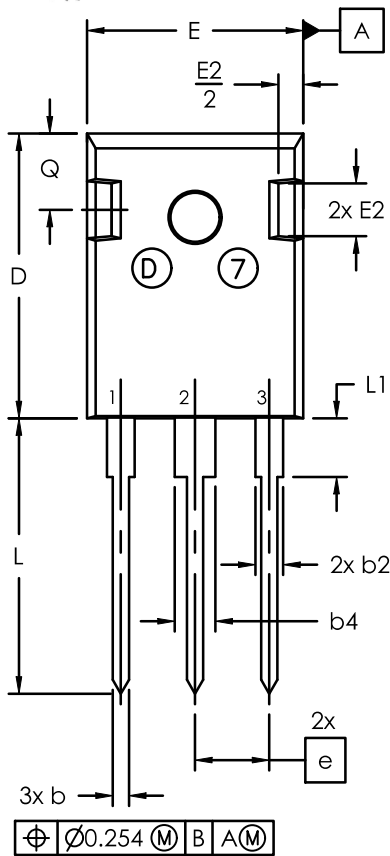

NOTE:

1. Dimensioning and tolerancing as per ASME Y14.5 - 2018
2. Controlling dimension : millimeters
3. Package Outline in compliance with JEDEC standard var. AD.
4. Dimensions D & E does not include mold flash.
5. ØP to have max draft angle of 1.7° to the top with max. hole diameter of 3.91mm.

SYM	millimeters		
	MIN	NOM	MAX
A	4.70	5.03	5.31
A1	2.21	2.40	2.59
A2	1.50	2.03	2.49
b	0.99	1.20	1.40
b2	1.65	2.03	2.39
b4	2.59	3.00	3.43
c	0.38	0.60	0.89
D	20.70	20.96	21.46
D1	13.08	—	—
D2	0.51	1.19	1.35
E	15.49	15.90	16.26
e	5.44 BSC		
E1	13.00	13.30	13.60
E2	3.43	3.89	5.20
L	19.62	20.27	20.32
L1	—	—	4.50
ØP	3.40	3.60	3.80
ØP1	7.06	7.19	7.39
Q	5.38	5.62	6.20
S	6.15 BSC		
Ø	3°		
Ø1	20°		
Ø2	10°		

DOCUMENT NUMBER:	98AON88794E	Electronic versions are uncontrolled except when accessed directly from the Document Repository. Printed versions are uncontrolled except when stamped "CONTROLLED COPY" in red.
DESCRIPTION:	TO247-3 15.90x20.96x5.03, 5.44P	PAGE 1 OF 1

onsemi and ONSEMI are trademarks of Semiconductor Components Industries, LLC dba onsemi or its subsidiaries in the United States and/or other countries. onsemi reserves the right to make changes without further notice to any products herein. onsemi makes no warranty, representation or guarantee regarding the suitability of its products for any particular purpose, nor does onsemi assume any liability arising out of the application or use of any product or circuit, and specifically disclaims any and all liability, including without limitation special, consequential or incidental damages. onsemi does not convey any license under its patent rights nor the rights of others.

onsemi, **Onsemi**, and other names, marks, and brands are registered and/or common law trademarks of Semiconductor Components Industries, LLC dba "**onsemi**" or its affiliates and/or subsidiaries in the United States and/or other countries. **onsemi** owns the rights to a number of patents, trademarks, copyrights, trade secrets, and other intellectual property. A listing of **onsemi**'s product/patent coverage may be accessed at www.onsemi.com/site/pdf/Patent-Marking.pdf. **onsemi** reserves the right to make changes at any time to any products or information herein, without notice. The information herein is provided "as-is" and **onsemi** makes no warranty, representation or guarantee regarding the accuracy of the information, product features, availability, functionality, or suitability of its products for any particular purpose, nor does **onsemi** assume any liability arising out of the application or use of any product or circuit, and specifically disclaims any and all liability, including without limitation special, consequential or incidental damages. Buyer is responsible for its products and applications using **onsemi** products, including compliance with all laws, regulations and safety requirements or standards, regardless of any support or applications information provided by **onsemi**. "Typical" parameters which may be provided in **onsemi** data sheets and/or specifications can and do vary in different applications and actual performance may vary over time. All operating parameters, including "Typicals" must be validated for each customer application by customer's technical experts. **onsemi** does not convey any license under any of its intellectual property rights nor the rights of others. **onsemi** products are not designed, intended, or authorized for use as a critical component in life support systems or any FDA Class 3 medical devices or medical devices with a same or similar classification in a foreign jurisdiction or any devices intended for implantation in the human body. Should Buyer purchase or use **onsemi** products for any such unintended or unauthorized application, Buyer shall indemnify and hold **onsemi** and its officers, employees, subsidiaries, affiliates, and distributors harmless against all claims, costs, damages, and expenses, and reasonable attorney fees arising out of, directly or indirectly, any claim of personal injury or death associated with such unintended or unauthorized use, even if such claim alleges that **onsemi** was negligent regarding the design or manufacture of the part. **onsemi** is an Equal Opportunity/Affirmative Action Employer. This literature is subject to all applicable copyright laws and is not for resale in any manner.

ADDITIONAL INFORMATION

TECHNICAL PUBLICATIONS:

Technical Library: www.onsemi.com/design/resources/technical-documentation
onsemi Website: www.onsemi.com

ONLINE SUPPORT: www.onsemi.com/support

For additional information, please contact your local Sales Representative at www.onsemi.com/support/sales