

MOSFET - Power, Single N-Channel, SO8FL

40 V, 4.7 mΩ, 66 A

NTMFS4D7N04XM

Features

- Low $R_{DS(on)}$ to Minimize Conduction Losses
- Low Capacitance to Minimize Driver Losses
- Small Footprint (5x6 mm) for Compact Design
- These Devices are Pb-Free, Halogen Free/BFR Free and are RoHS Compliant

Applications

- Motor Drive
- Battery Protection
- Oring

MAXIMUM RATINGS ($T_J = 25^\circ\text{C}$ unless otherwise noted)

Parameter	Symbol	Value	Unit
Drain-to-Source Voltage	V_{DSS}	40	V
Gate-to-Source Voltage	DC V_{GS}	± 20	V
Continuous Drain Current	I_D	$T_C = 25^\circ\text{C}$	66
		$T_C = 100^\circ\text{C}$	47
Power Dissipation	$T_C = 25^\circ\text{C}$ P_D	38	W
Pulsed Drain Current	$T_C = 25^\circ\text{C}$, $t_p = 10 \mu\text{s}$ I_{DM}	375	A
Operating Junction and Storage Temperature Range	T_J, T_{stg}	-55 to +175	$^\circ\text{C}$
Source Current (Body Diode)	I_S	32	A
Single Pulse Avalanche Energy ($I_{PK} = 32 \text{ A}$)	E_{AS}	68	mJ
Lead Temperature for Soldering Purposes (1/8" from case for 10 s)	T_L	260	$^\circ\text{C}$

Stresses exceeding those listed in the Maximum Ratings table may damage the device. If any of these limits are exceeded, device functionality should not be assumed, damage may occur and reliability may be affected.

THERMAL CHARACTERISTICS

Parameter	Symbol	Value	Unit
Thermal Resistance, Junction-to-Case (Note 2)	$R_{\theta JC}$	3.9	$^\circ\text{C}/\text{W}$
Thermal Resistance, Junction-to-Ambient (Notes 1, 2)	$R_{\theta JA}$	42	

1. Surface-mounted on FR4 board using 650 mm², 2 oz. Cu pad.
2. The entire application environment impacts the thermal resistance values shown, they are not constants and are only valid for the particular conditions noted.

$V_{(BR)DSS}$	$R_{DS(ON)} \text{ MAX}$	$I_D \text{ MAX}$
40 V	4.7 mΩ @ 10 V	66 A

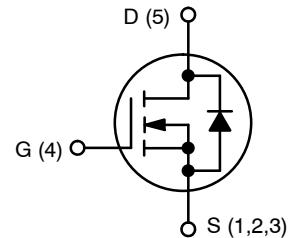

N-CHANNEL MOSFET

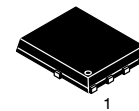

DFN5 (SO-8FL)
CASE 488AA

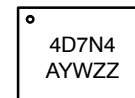

4D7N4 = Specific Device Code
 A = Assembly Location
 Y = Year
 W = Work Week
 ZZ = Assembly Lot Code

ORDERING INFORMATION

Device	Package	Shipping [†]
NTMFS4D7N04XMT1G	DFN5 (Pb-Free)	1500 / Tape & Reel

[†]For information on tape and reel specifications, including part orientation and tape sizes, please refer to our Tape and Reel Packaging Specification Brochure, BRD8011/D.

NTMFS4D7N04XM

ELECTRICAL CHARACTERISTICS (T_J = 25°C unless otherwise noted)

Parameter	Symbol	Test Conditions	Min	Typ	Max	Unit
-----------	--------	-----------------	-----	-----	-----	------

OFF CHARACTERISTICS

Drain-to-Source Breakdown Voltage	V _{(BR)DSS}	V _{GS} = 0 V, I _D = 1 mA, T _J = 25°C	40	-	-	V
Drain-to-Source Breakdown Voltage Temperature Coefficient	ΔV _{(BR)DSS} /ΔT _J	I _D = 1 mA, Referenced to 25°C	-	15	-	mV/°C
Zero Gate Voltage Drain Current	I _{DSS}	V _{DS} = 40 V, T _J = 25°C	-	-	10	μA
		V _{DS} = 40 V, T _J = 125°C	-	-	100	
Gate-to-Source Leakage Current	I _{GSS}	V _{GS} = 20 V, V _{DS} = 0 V	-	-	100	nA

ON CHARACTERISTICS

Drain-to-Source On Resistance	R _{DS(on)}	V _{GS} = 10 V, I _D = 10 A, T _J = 25°C	-	4.1	4.7	mΩ
Gate Threshold Voltage	V _{GS(TH)}	V _{GS} = V _{DS} , I _D = 30 μA, T _J = 25°C	2.5	-	3.5	V
Gate Threshold Voltage Temperature Coefficient	ΔV _{GS(TH)} /ΔT _J	V _{GS} = V _{DS} , I _D = 30 μA	-	-7.29	-	mV/°C
Forward Transconductance	g _{FS}	V _{DS} = 5 V, I _D = 10 A	-	45.5	-	S

CHARGES, CAPACITANCES & GATE RESISTANCE

Input Capacitance	C _{ISS}	V _{DS} = 20 V, V _{GS} = 0 V, f = 1 MHz	-	668	-	pF
Output Capacitance	C _{OSS}		-	479	-	
Reverse Transfer Capacitance	C _{RSS}		-	13.6	-	
Total Gate Charge	Q _{G(TOT)}	V _{DD} = 20 V, I _D = 30 A, V _{GS} = 10 V	-	10.4	-	nC
Threshold Gate Charge	Q _{G(TH)}		-	1.97	-	
Gate-to-Source Charge	Q _{GS}		-	3.19	-	
Gate-to-Drain Charge	Q _{GD}		-	1.92	-	
Gate-Resistance	R _G	f = 1 MHz	-	1.6	-	Ω

SWITCHING CHARACTERISTICS

Turn-On Delay Time	t _{d(ON)}	Resistive Load, V _{GS} = 0/10 V, V _{DD} = 20 V, I _D = 30 A, R _G = 0 Ω	-	12	-	ns
Rise Time	t _r		-	4.13	-	
Turn-Off Delay Time	t _{d(OFF)}		-	16.3	-	
Fall Time	t _f		-	3.81	-	

SOURCE-TO-DRAIN DIODE CHARACTERISTICS

Forward Diode Voltage	V _{SD}	I _S = 10 A, V _{GS} = 0 V, T _J = 25°C	-	0.8	1.2	V
		I _S = 10 A, V _{GS} = 0 V, T _J = 125°C	-	0.7	-	
Reverse Recovery Time	t _{RR}	V _{GS} = 0 V, I _S = 30 A, di/dt = 100 A/μs, V _{DD} = 20 V, T _J = 25°C	-	21.6	-	ns
Charge Time	t _a		-	9.01	-	
Discharge Time	t _b		-	12.6	-	
Reverse Recovery Charge	Q _{RR}		-	11.6	-	nC

Product parametric performance is indicated in the Electrical Characteristics for the listed test conditions, unless otherwise noted. Product performance may not be indicated by the Electrical Characteristics if operated under different conditions.

NTMFS4D7N04XM

TYPICAL CHARACTERISTICS

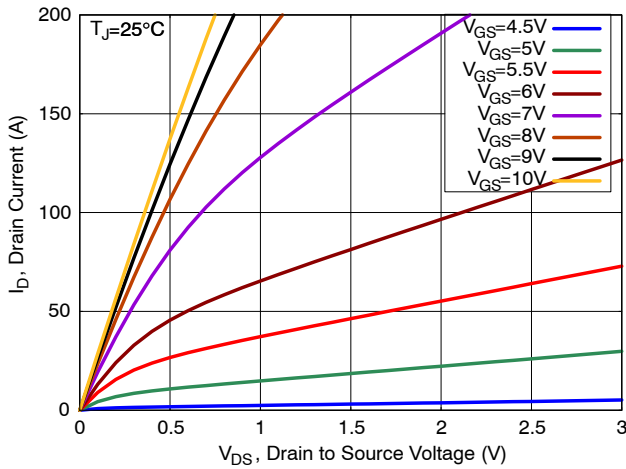

Figure 1. On-Region Characteristics

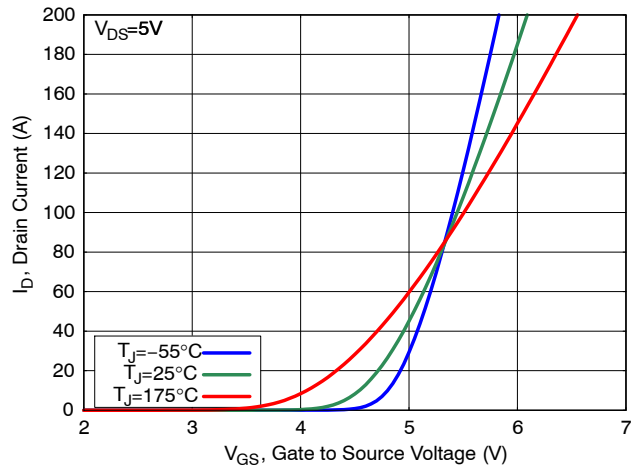

Figure 2. Transfer Characteristics

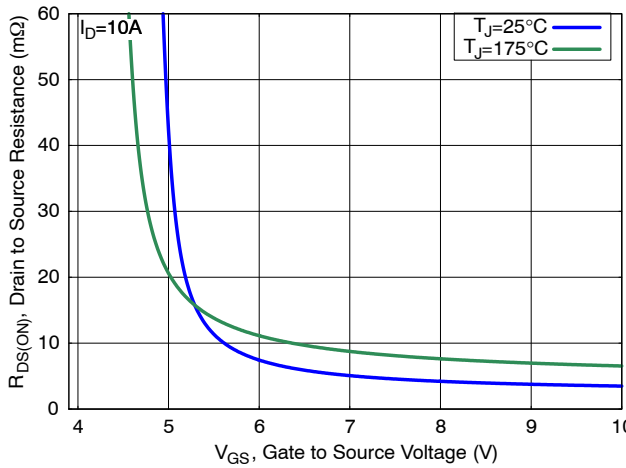

Figure 3. On-Resistance vs. Gate Voltage

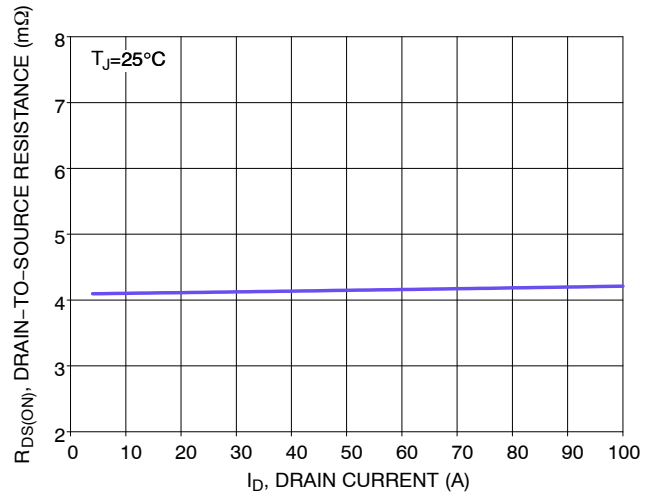

Figure 4. On-Resistance vs. Drain Current

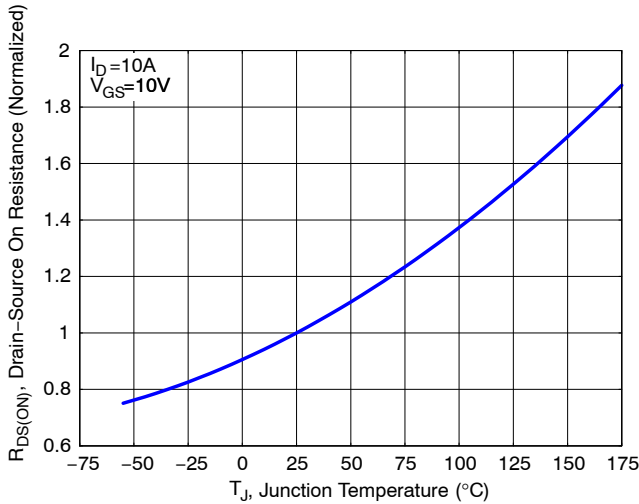

Figure 5. Normalized On-Resistance vs. Junction Temperature

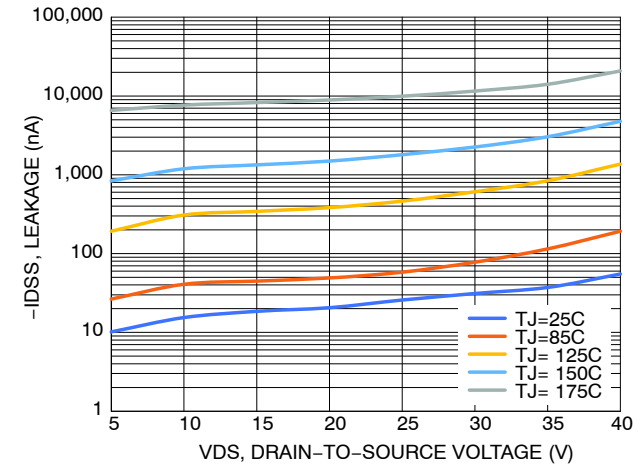

Figure 6. Drain Leakage Current vs. Drain Voltage

NTMFS4D7N04XM

TYPICAL CHARACTERISTICS

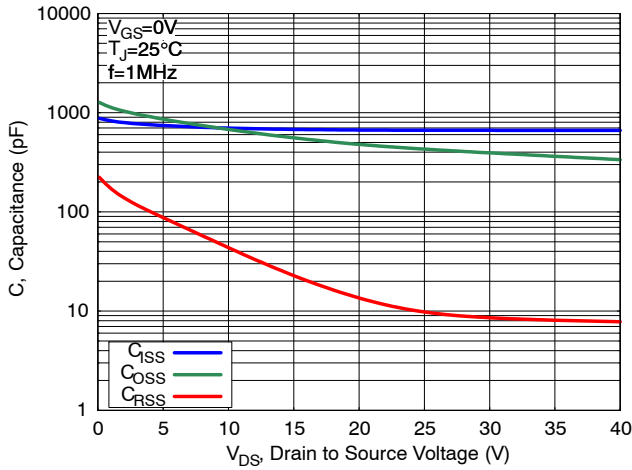

Figure 7. Capacitance Characteristics

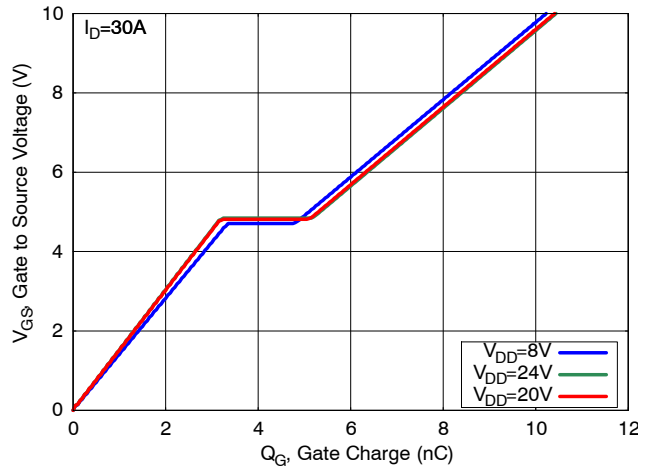

Figure 8. Gate Charge Characteristics

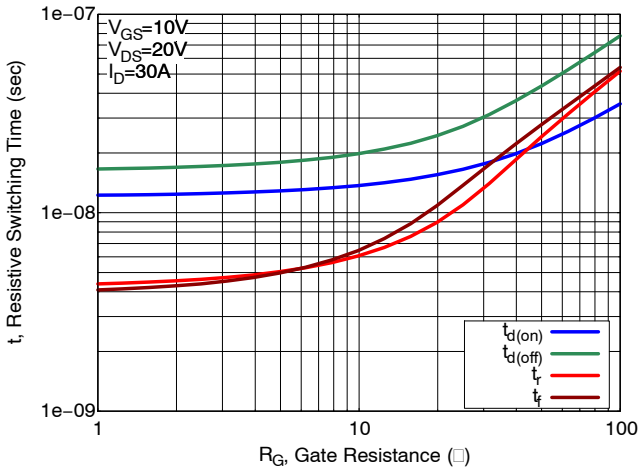

Figure 9. Resistive Switching Time Variation vs. Gate Resistance

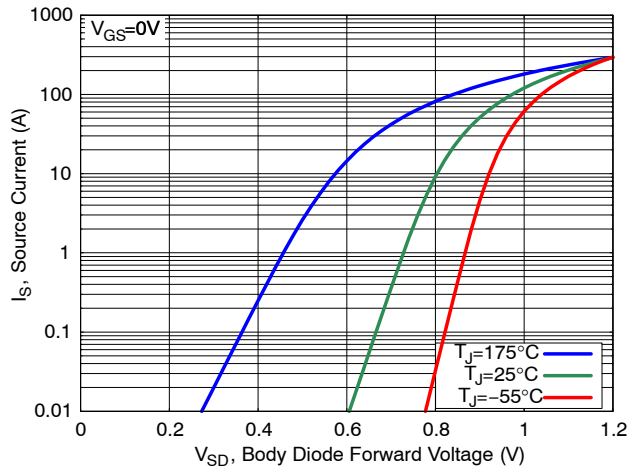

Figure 10. Diode Forward Characteristics

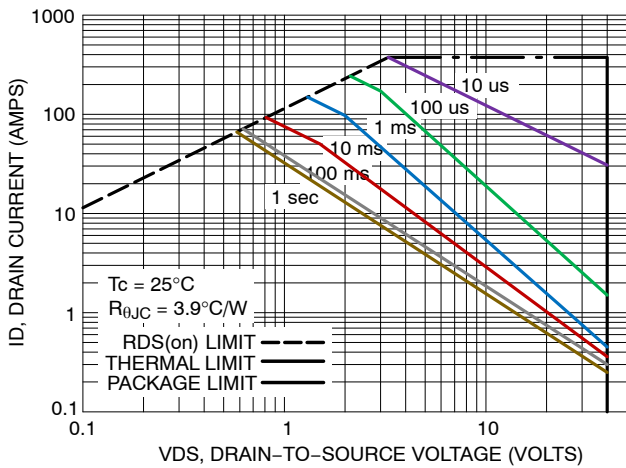

Figure 11. Safe Operating Area (SOA)

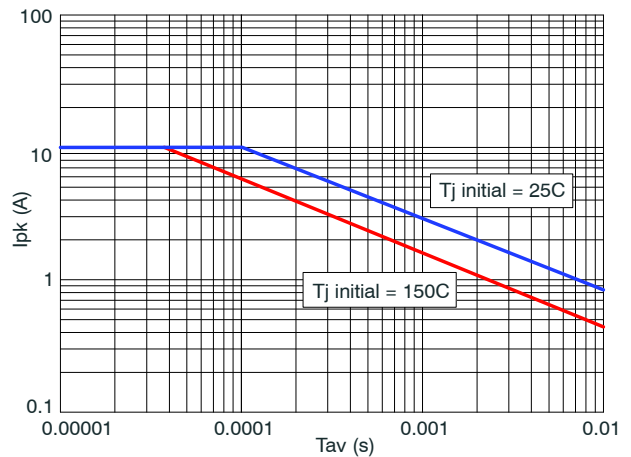

Figure 12. Avalanche Current vs. Pulse Time (UIS)

NTMFS4D7N04XM

TYPICAL CHARACTERISTICS

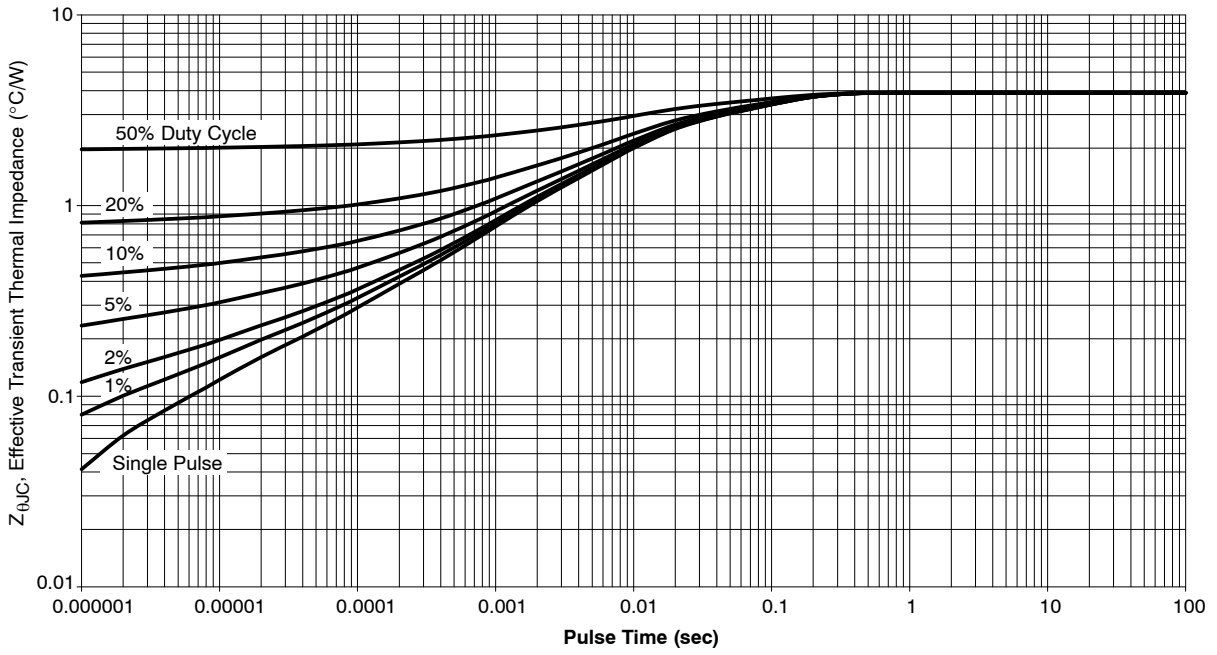

Figure 13. Transient Thermal Response

NTMFS4D7N04XM

PACKAGE DIMENSIONS

DFN5 5x6, 1.27P
(SO-8FL)
CASE 488AA
ISSUE N

NOTES:

1. DIMENSIONING AND TOLERANCING PER ASME Y14.5M, 1994.
2. CONTROLLING DIMENSION: MILLIMETER.
3. DIMENSION D1 AND E1 DO NOT INCLUDE MOLD FLASH PROTRUSIONS OR GATE BURRS.

DIM	MILLIMETERS		
	MIN	NOM	MAX
A	0.90	1.00	1.10
A1	0.00	---	0.05
b	0.33	0.41	0.51
c	0.23	0.28	0.33
D	5.00	5.15	5.30
D1	4.70	4.90	5.10
D2	3.80	4.00	4.20
E	6.00	6.15	6.30
E1	5.70	5.90	6.10
E2	3.45	3.65	3.85
e	1.27 BSC		
G	0.51	0.575	0.71
K	1.20	1.35	1.50
L	0.51	0.575	0.71
L1	0.125 REF		
M	3.00	3.40	3.80
θ	0°	---	12°

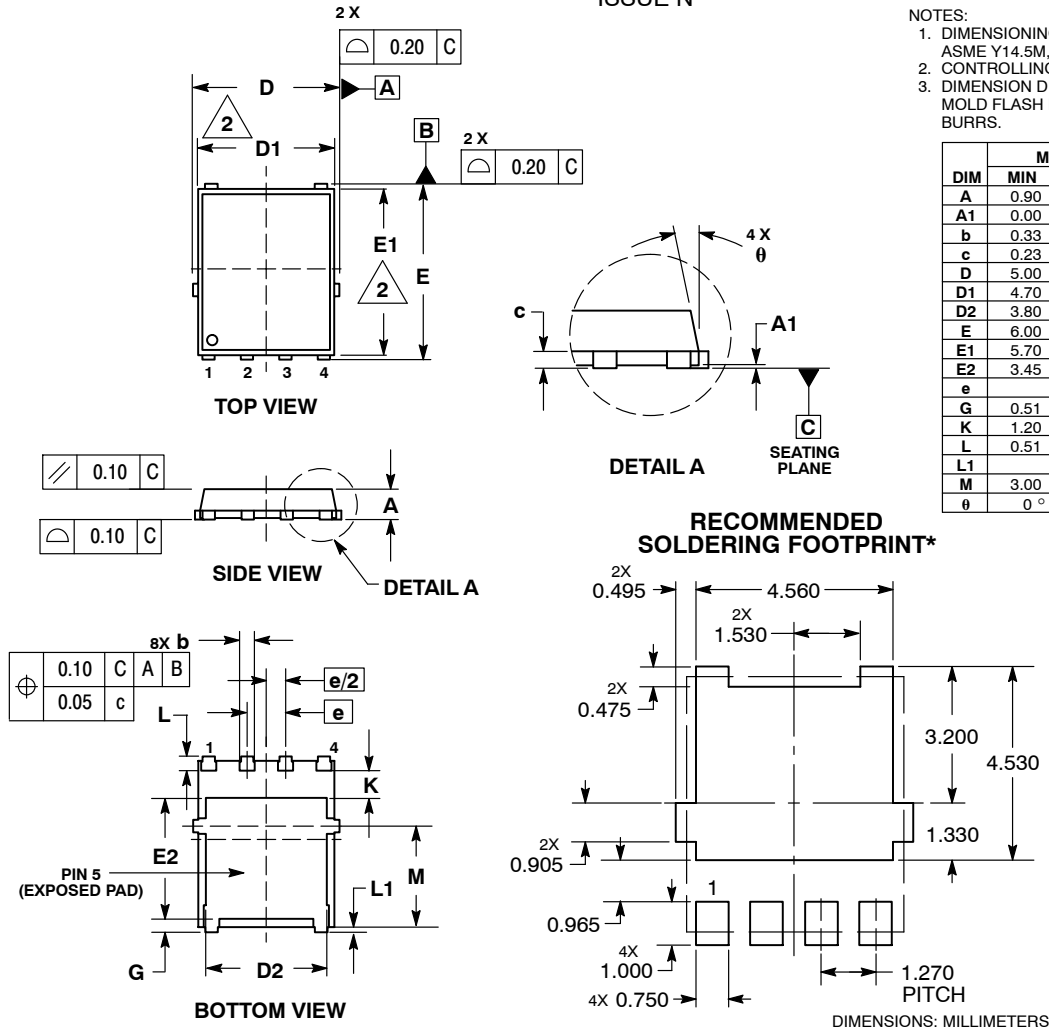

STYLE 1:
PIN 1. SOURCE
2. SOURCE
3. SOURCE
4. GATE
5. DRAIN

*For additional information on our Pb-Free strategy and soldering details, please download the **onsemi** Soldering and Mounting Techniques Reference Manual, SOLDERRM/D.

onsemi, **Onsemi**, and other names, marks, and brands are registered and/or common law trademarks of Semiconductor Components Industries, LLC dba "**onsemi**" or its affiliates and/or subsidiaries in the United States and/or other countries. **onsemi** owns the rights to a number of patents, trademarks, copyrights, trade secrets, and other intellectual property. A listing of **onsemi**'s product/patent coverage may be accessed at www.onsemi.com/site/pdf/Patent-Marking.pdf. **onsemi** reserves the right to make changes at any time to any products or information herein, without notice. The information herein is provided "as-is" and **onsemi** makes no warranty, representation or guarantee regarding the accuracy of the information, product features, availability, functionality, or suitability of its products for any particular purpose, nor does **onsemi** assume any liability arising out of the application or use of any product or circuit, and specifically disclaims any and all liability, including without limitation special, consequential or incidental damages. Buyer is responsible for its products and applications using **onsemi** products, including compliance with all laws, regulations and safety requirements or standards, regardless of any support or applications information provided by **onsemi**. "Typical" parameters which may be provided in **onsemi** data sheets and/or specifications can and do vary in different applications and actual performance may vary over time. All operating parameters, including "Typicals" must be validated for each customer application by customer's technical experts. **onsemi** does not convey any license under any of its intellectual property rights nor the rights of others. **onsemi** products are not designed, intended, or authorized for use as a critical component in life support systems or any FDA Class 3 medical devices or medical devices with a same or similar classification in a foreign jurisdiction or any devices intended for implantation in the human body. Should Buyer purchase or use **onsemi** products for any such unintended or unauthorized application, Buyer shall indemnify and hold **onsemi** and its officers, employees, subsidiaries, affiliates, and distributors harmless against all claims, costs, damages, and expenses, and reasonable attorney fees arising out of, directly or indirectly, any claim of personal injury or death associated with such unintended or unauthorized use, even if such claim alleges that **onsemi** was negligent regarding the design or manufacture of the part. **onsemi** is an Equal Opportunity/Affirmative Action Employer. This literature is subject to all applicable copyright laws and is not for resale in any manner.

ADDITIONAL INFORMATION

TECHNICAL PUBLICATIONS:

Technical Library: www.onsemi.com/design/resources/technical-documentation
onsemi Website: www.onsemi.com

ONLINE SUPPORT: www.onsemi.com/support

For additional information, please contact your local Sales Representative at www.onsemi.com/support/sales