

Voltage-Level Translator, Dual Bidirectional I²C-bus and SMBus

NLA9306

The NLA9306 is a dual bidirectional I²C-bus and SMBus voltage-level translator with an enable (EN) input.

Features

- 2-bit Bidirectional Translator for SDA and SCL Lines in Mixed-Mode I²C-Bus Applications
- Standard-Mode, Fast-Mode, and Fast-Mode Plus I²C-Bus and SMBus Compatible
- Less Than 1.5 ns Maximum Propagation Delay to Accommodate Standard-Mode and Fast-Mode I²C-Bus Devices and Multiple Masters
- Allows Voltage Level Translation Between:
 - ◆ 1.0 V V_{ref(1)} and 1.8 V, 2.5 V, 3.3 V or 5 V V_{bias(ref)(2)}
 - ◆ 1.2 V V_{ref(1)} and 1.8 V, 2.5 V, 3.3 V or 5 V V_{bias(ref)(2)}
 - ◆ 1.8 V V_{ref(1)} and 3.3 V or 5 V V_{bias(ref)(2)}
 - ◆ 2.5 V V_{ref(1)} and 5 V V_{bias(ref)(2)}
 - ◆ 3.3 V V_{ref(1)} and 5 V V_{bias(ref)(2)}
- Provides Bidirectional Voltage Translation With No Direction Pin
- Low 3.5 Ω ON-State Connection Between Input and Output Ports Provides Less Signal Distortion
- Open-Drain I²C-Bus I/O Ports (SCL1, SDA1, SCL2 and SDA2)
- 5 V Tolerant I²C-Bus I/O Ports to Support Mixed-Mode Signal Operation
- High-Impedance SCL1, SDA1, SCL2 and SDA2 Pins for EN = LOW
- Lock-Up Free Operation
- Flow Through Pinout for Ease of Printed-Circuit Board Trace Routing
- Packages Offered:
 - ◆ US8, UQFN8, UDFN8, TSSOP-8
- ESD Performance: 2000 V Human Body Model
- -Q Suffix for Automotive and Other Applications Requiring Unique Site and Control Change Requirements; AEC-Q100 Qualified and PPAP Capable
- These Devices are Pb-Free, Halogen Free/BFR Free and are RoHS Compliant



TSSOP-8
DT SUFFIX
CASE 948AL

MARKING DIAGRAMS

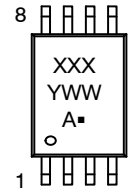

US8
US SUFFIX
CASE 493

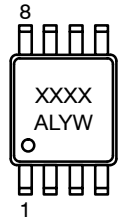

UQFN8
MU SUFFIX
CASE 523AN

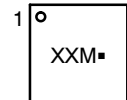

UDFN8
1.45 x 1.0
CASE 517BZ

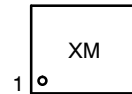

XXXX = Specific Device Code
 A = Assembly Location
 L = Lot Code
 Y = Year
 W, WW = Work Week
 M = Date Code
 ■ = Pb-Free Package

ORDERING INFORMATION

See detailed ordering and shipping information on page 9 of this data sheet.

Function Description

The NLA9306 is a dual bidirectional I²C-bus and SMBus voltage-level translator with an enable (EN) input, and is operational from 1.0 V to 3.6 V (V_{ref(1)}) and 1.8 V to 5.5 V (V_{bias(ref)(2)}).

The NLA9306 allows bidirectional voltage translations between 1.0 V and 5 V without the use of a direction pin. The low ON-state resistance (R_{on}) of the switch allows connections to be made with minimal propagation delay. When EN is HIGH, the translator switch is on, and the SCL1 and SDA1 I/O are connected to the SCL2 and SDA2 I/O, respectively, allowing bidirectional data flow between ports. When EN is LOW, the translator switch is off, and a high-impedance state exists between ports.

The NLA9306 is not a bus buffer that provides both level translation and physical capacitance isolation to either side of the bus when both sides are connected. The NLA9306 only isolates both sides when the device is disabled and provides voltage level translation when active.

The NLA9306 can be used to run two buses, one at 400 kHz operating frequency and the other at 100 kHz operating frequency. If the two buses are operating at different frequencies, the 100 kHz bus must be isolated when the 400 kHz operation of the other bus is required. If the master is running at 400 kHz, the maximum system operating frequency may be less than 400 kHz because of the delays added by the translator.

As with the standard I²C-bus system, pull-up resistors are required to provide the logic HIGH levels on the translator's

bus. The NLA9306 has a standard open-collector configuration of the I²C-bus. The size of these pull-up resistors depends on the system, but each side of the translator must have a pull-up resistor. The device is designed to work with Standard-mode, Fast-mode and Fast mode Plus I²C-bus devices in addition to SMBus devices. The maximum frequency is dependent on the RC time constant, but generally supports > 2 MHz.

When the SDA1 or SDA2 port is LOW, the clamp is in the ON-state and a low resistance connection exists between the SDA1 and SDA2 ports. Assuming the higher voltage is on the SDA2 port, when the SDA2 port is HIGH, the voltage on the SDA1 port is limited to the voltage set by VREF1. When the SDA1 port is HIGH, the SDA2 port is pulled to the drain pull-up supply voltage (V_{pu(D)}) by the pull-up resistors. This functionality allows a seamless translation between higher and lower voltages selected by the user without the need for directional control. The SCL1/SCL2 channel also functions as the SDA1/SDA2 channel.

All channels have the same electrical characteristics and there is minimal deviation from one output to another in voltage or propagation delay. This is a benefit over discrete transistor voltage translation solutions, since the fabrication of the switch is symmetrical. The translator provides excellent ESD protection to lower voltage devices, and at the same time protects less ESD-resistant devices.

FUNCTIONAL DIAGRAM

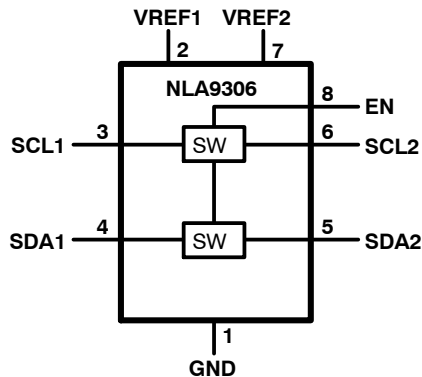

Figure 1. Logic Diagram

NLA9306

PIN ASSIGNMENTS

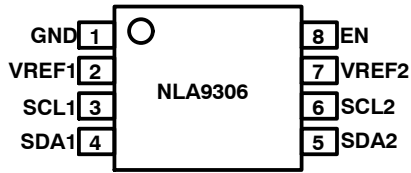

Figure 2. US8/TSSOP-8 Pinouts

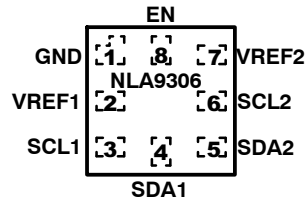

Figure 3. UQFN8 Pinout (Top Thru View)

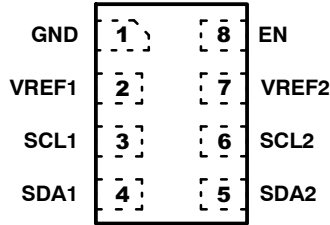

Figure 4. UDFN8 Pinout (Top Thru View)

Table 1. PIN DESCRIPTION

Pin	Description
GND	Ground
VREF1	Low-voltage side reference supply voltage for SCL1 and SDA1
SCL1	Serial clock, low-voltage side; connect to VREF1 through a pull-up resistor
SDA1	Serial data, low-voltage side; connect to VREF1 through a pull-up resistor
SDA2	Serial data, high-voltage side; connect to VREF2 through a pull-up resistor
SCL2	Serial clock, high-voltage side; connect to VREF2 through a pull-up resistor
VREF2	High-voltage side reference supply voltage for SCL2 and SDA2
EN	Switch enable input; connect to VREF2 and pull-up through a high resistor

Table 2. FUNCTION TABLE

Input EN (Note 1)	Function
Low	Disconnect
High	SCL1 = SCL2; SDA1 = SDA2

1. EN is controlled by the $V_{\text{bias(ref)(2)}}$ logic levels and should be at least 1 V higher than $V_{\text{ref(1)}}$ for best translator operation.

Table 3. MAXIMUM RATINGS

Symbol	Parameter	Value	Unit
$V_{ref(1)}$	Reference Voltage (Note 2)	-0.5 to +7.0	V
$V_{bias(ref)(2)}$	Reference Bias Voltage (Note 3)	-0.5 to +7.0	V
V_{IN}	Input Voltage	-0.5 to +7.0	V
$V_{I/O}$	Input / Output Pin Voltage	-0.5 to +7.0	V
I_{CH}	DC Channel Current	128	mA
I_{IK}	DC Input Diode Current $V_{IN} < GND$	-50	mA
T_{STG}	Storage Temperature Range	-65 to +150	°C
T_L	Lead Temperature, 1 mm from Case for 10 Seconds	$T_L = 260$	°C
T_J	Junction Temperature Under Bias	$T_J = 150$	°C
θ_{JA}	Thermal Resistance (Note 2)	$\theta_{JA} = 150$	°C/W
P_D	Power Dissipation in Still Air at 85°C	$P_D = 833$	mW
MSL	Moisture Sensitivity	Level 1	
F_R	Flammability Rating Oxygen Index: 28 to 34	UL 94 V-0 @ 0.125 in	
V_{ESD}	ESD Withstand Voltage Human Body Mode (Note 3) Machine Model (Note 4) Charged Device Model (Note 5)	> 2000 N/A > 1000	V
$I_{LATCHUP}$	Latchup Performance Above V_{CC} and Below GND at 125°C (Note 6)	± 100	mA

Stresses exceeding those listed in the Maximum Ratings table may damage the device. If any of these limits are exceeded, device functionality should not be assumed, damage may occur and reliability may be affected.

2. Measured with minimum pad spacing on an FR4 board, using 10 mm-by-1 inch, 2 ounce copper trace no air flow.
3. Tested to ANSI / ESDA / JEDEC JS-001-2017.
4. JEDEC recommends that ESD qualification to EIA / JESD22-A115-A (Machine Model) be discontinued per JEDEC / JEP172A.
5. Tested to EIA / JESD22-C101-F.
6. Tested to EIA / JESD78 Class II.

Table 4. RECOMMENDED OPERATING CONDITIONS

Symbol	Parameter	Min	Max	Unit
$V_{ref(1)}$	Reference Voltage (1) (Note 7) VREF1	0	5.5	V
$V_{bias(ref)(2)}$	Reference Bias Voltage (2) (Note 7) VREF2	0	5.5	V
$V_{I/O}$	Input / Output Pin Voltage SCL1, SDA1, SCL2, SDA2	0	5.5	V
$V_{I(EN)}$	Control Pin Input Voltage EN	0	5.5	V
$I_{sw(pass)}$	Pass Switch Current	0	64	mA
T_A	Operating Free-Air Temperature	-55	+125	°C

Functional operation above the stresses listed in the Recommended Operating Ranges is not implied. Extended exposure to stresses beyond the Recommended Operating Ranges limits may affect device reliability.

7. $V_{(ref)(1)} \leq V_{bias(ref)(2)} - 1$ V for best results in level shifting applications.

Table 5. DC ELECTRICAL CHARACTERISTICS

Symbol	Parameter	Conditions	T _A = -55°C to +125°C			Unit
			Min	Typ (Note 8)	Max	
V _{IK}	Input Clamping Voltage	I _I = -18 mA; V _{I(EN)} = 0 V			-1.2	V
I _{IH}	High-Level Input Current	V _I = 5 V; V _{I(EN)} = 0 V			5	μA
C _{I(EN)}	EN Pin Input Capacitance	V _I = 3 V or 0 V		7.1		pF
C _{I/O(off)}	OFF-State I/O Pin Capacitance SCLn, SDAn	V _O = 3 V or 0 V; V _{I(EN)} = 0 V		4	6	pF
C _{I/O(on)}	ON-State I/O Pin Capacitance SCLn, SDAn	V _O = 3 V or 0 V; V _{I(EN)} = 3 V		9.3	13.1	pF
R _{ON}	ON-State Resistance ⁽²⁾⁽³⁾ SCLn, SDAn	V _I = 0 V; I _O = 64 mA V _{I(EN)} = 4.5 V V _{I(EN)} = 3 V V _{I(EN)} = 2.3 V V _{I(EN)} = 1.5 V		2.4 3.0 3.8 9.0	5.0 6.0 8.0 20	Ω
		V _I = 2.4 V; I _O = 15 mA V _{I(EN)} = 4.5 V V _{I(EN)} = 3 V		4.8 46	7.5 80	
		V _I = 1.7 V; I _O = 15 mA V _{I(EN)} = 2.3 V		40	80	

Product parametric performance is indicated in the Electrical Characteristics for the listed test conditions, unless otherwise noted. Product performance may not be indicated by the Electrical Characteristics if operated under different conditions.

8. All typical values are at T_A = 25°C.

9. Measured by the voltage drop between the SCL1 and SCL2, or SDA1 and SDA2 terminals at the indicated current through the switch. ON-state resistance is determined by the lowest voltage of the two terminals.

10. Guaranteed by design.

Table 6. AC ELECTRICAL CHARACTERISTICS (Translating Down) – Values Guaranteed by Design

Symbol	Parameter	Test Condition	Load Condition	T _A = -55°C to +125°C		Unit
				Min	Max	
SEE FIGURE 4 LOAD SWITCH AT S2 POSITION						
t _{PLH}	Low-to-High Propagation Delay, from (input) SCL2 or SDA2 to (output) SCL1 or SDA1	V _{I(EN)} = 3.3 V; V _{IH} = 3.3 V; V _{IL} = 0 V; V _M = 1.15 V	C _L = 15 pF	0	0.6	ns
			C _L = 30 pF	0	1.2	
			C _L = 50 pF	0	2.0	
t _{PHL}	High-to-Low Propagation Delay, from (input) SCL2 or SDA2 to (output) SCL1 or SDA1	V _{I(EN)} = 2.5 V; V _{IH} = 2.5 V; V _{IL} = 0 V; V _M = 0.75 V	C _L = 15 pF	0	0.75	ns
			C _L = 30 pF	0	1.5	
			C _L = 50 pF	0	2.0	
t _{PLH}	Low-to-High Propagation Delay, from (input) SCL2 or SDA2 to (output) SCL1 or SDA1	V _{I(EN)} = 2.5 V; V _{IH} = 2.5 V; V _{IL} = 0 V; V _M = 0.75 V	C _L = 15 pF	0	0.6	ns
			C _L = 30 pF	0	1.2	
			C _L = 50 pF	0	2.0	
t _{PHL}	High-to-Low Propagation Delay, from (input) SCL2 or SDA2 to (output) SCL1 or SDA1	V _{I(EN)} = 2.5 V; V _{IH} = 2.5 V; V _{IL} = 0 V; V _M = 0.75 V	C _L = 15 pF	0	0.75	ns
			C _L = 30 pF	0	1.5	
			C _L = 50 pF	0	2.5	

Table 7. AC ELECTRICAL CHARACTERISTICS (Translating Up) – Values Guaranteed by Design

Symbol	Parameter	Test Condition	Load Condition	T _A = -55°C to +125°C		Unit
				Min	Max	
SEE FIGURE 4 LOAD SWITCH AT S1 POSITION						
t _{PLH}	Low-to-High Propagation Delay, from (input) SCL1 or SDA1 to (output) SCL2 or SDA2	V _{I(EN)} = 3.3 V; V _{IH} = 2.3 V; V _{IL} = 0 V; V _{TT} = 3.3 V; V _M = 1.15 V	R _L = 300 Ω, C _L = 15 pF	0	0.5	ns
			R _L = 300 Ω, C _L = 30 pF	0	1.0	
			R _L = 300 Ω, C _L = 50 pF	0	1.75	
t _{PHL}	High-to-Low Propagation Delay, from (input) SCL1 or SDA1 to (output) SCL2 or SDA2		R _L = 300 Ω, C _L = 15 pF	0	0.8	
			R _L = 300 Ω, C _L = 30 pF	0	1.65	
			R _L = 300 Ω, C _L = 50 pF	0	2.75	
t _{PLH}	Low-to-High Propagation Delay, from (input) SCL1 or SDA1 to (output) SCL2 or SDA2	V _{I(EN)} = 2.5 V; V _{IH} = 1.5 V; V _{IL} = 0 V; V _{TT} = 2.5 V; V _M = 0.75 V	R _L = 300 Ω, C _L = 15 pF	0	0.5	ns
			R _L = 300 Ω, C _L = 30 pF	0	1.0	
			R _L = 300 Ω, C _L = 50 pF	0	1.75	
t _{PHL}	High-to-Low Propagation Delay, from (input) SCL1 or SDA1 to (output) SCL2 or SDA2		R _L = 300 Ω, C _L = 15 pF	0	1.0	
			R _L = 300 Ω, C _L = 30 pF	0	2.0	
			R _L = 300 Ω, C _L = 50 pF	0	3.3	

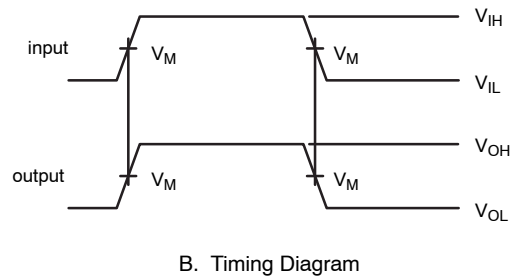
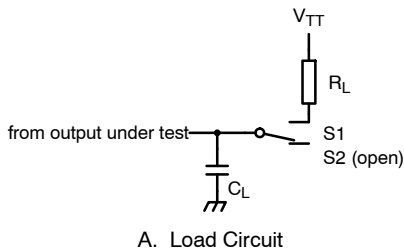

S1 = translating up; S2 = translating down.

C_L includes probe and jig capacitance.

All input pulses are supplied by generators having the following characteristics: PRR ≤ 10 MHz; Z₀ = 50 Ω; t_r ≤ 2 ns; t_f ≤ 2 ns.

The outputs are measured one at a time, with one transition per measurement.

Figure 5. Load Circuit for Outputs

APPLICATION INFORMATION

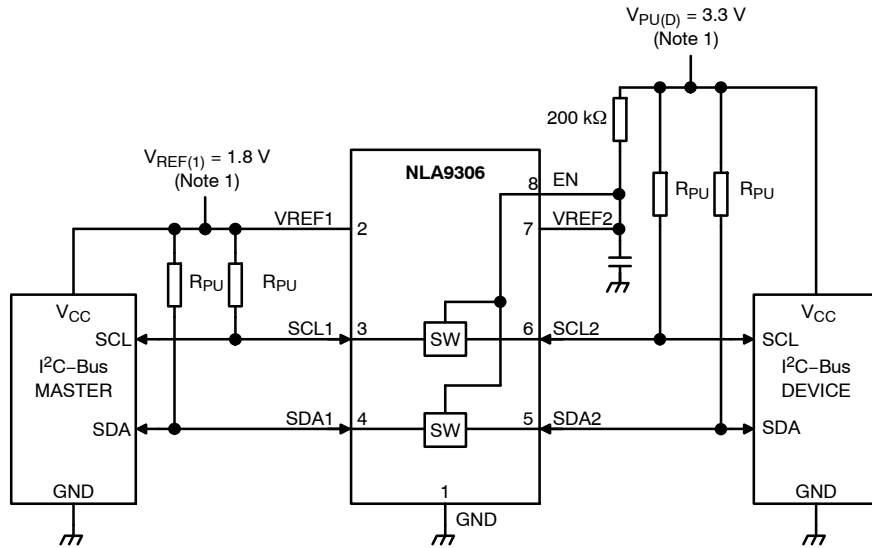

1. The applied voltages at $V_{ref(1)}$ and $V_{pu(D)}$ should be such that $V_{bias(ref)(2)}$ is at least 1 V higher than $V_{ref(1)}$ for best translator operation.

Figure 6. Typical Application (Switch Always Enabled)

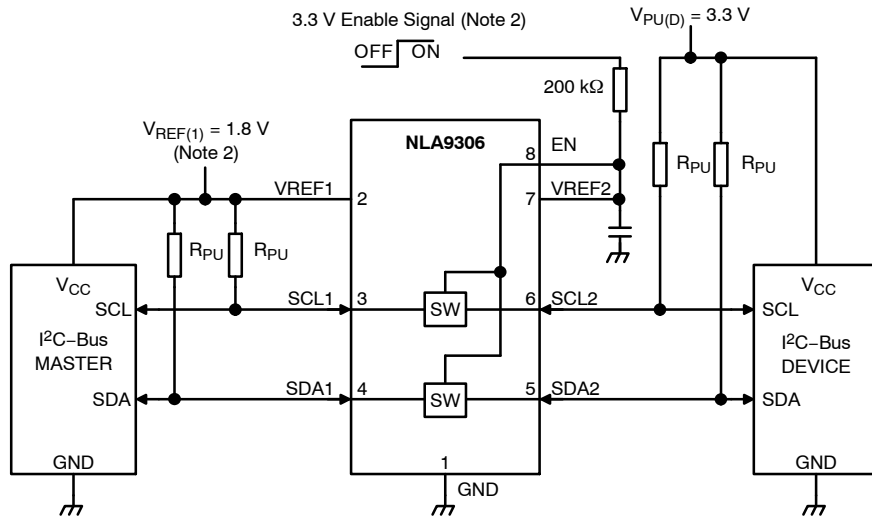

2. In the Enabled mode, the applied enable voltage and the applied voltage at $V_{ref(1)}$ should be such that $V_{bias(ref)(2)}$ is at least 1 V higher than $V_{ref(1)}$ for best translator operation.

Figure 7. Typical Application (Switch Enable Control)

Bidirectional Translation

For the bidirectional clamping configuration (higher voltage to lower voltage or lower voltage to higher voltage), the EN input must be connected to VREF2 and both pins pulled to HIGH side $V_{pu(D)}$ through a pull-up resistor (typically 200 kΩ). This allows VREF2 to regulate the EN input. A filter capacitor on VREF2 is recommended. The I²C-bus master output can be totem-pole or open-drain (pull-up resistors may be required) and the I²C-bus device output can be totem-pole or open-drain (pull-up resistors are required to pull the SCL2 and SDA2 outputs to $V_{pu(D)}$). However, if either output is totem-pole, data must be

unidirectional or the outputs must be 3-stateable and be controlled by some direction-control mechanism to prevent HIGH-to-LOW contentions in either direction. If both outputs are open-drain, no direction control is needed.

The reference supply voltage ($V_{ref(1)}$) is connected to the processor core power supply voltage. When VREF2 is connected through a 200 kΩ resistor to a 3.3 V to 5.5 V $V_{pu(D)}$ power supply, and $V_{ref(1)}$ is set between 1.0 V and ($V_{pu(D)} - 1$ V), the output of each SCL1 and SDA1 has a maximum output voltage equal to VREF1, and the output of each SCL2 and SDA2 has a maximum output voltage equal to $V_{pu(D)}$.

Table 8. APPLICATION OPERATING CONDITIONS Refer to Figure 6.

Symbol	Parameter	Conditions	Min	Typ ⁽¹⁾	Max	Unit
V _{bias(ref)(2)}	Reference Bias Voltage (2)		V _{ref(1)} + 0.6	2.1	5	V
V _{I(EN)}	EN Pin Input Voltage		V _{ref(1)} + 0.6	2.1	5	V
V _{ref(1)}	Reference Voltage (1)		0	1.5	4.4	V
I _{sw(pass)}	Pass Switch Current			14		mA
I _{ref}	Reference Current	Transistor		5		μA
T _{amb}	Ambient Temperature	Operating in free-air	-55		+125	°C

11. All typical values are at T_{amb} = 25°C.

Sizing Pull-up Resistor

The pull-up resistor value needs to limit the current through the pass transistor when it is in the ON state to about 15 mA. This ensures a pass voltage of 260 mV to 350 mV. If the current through the pass transistor is higher than 15 mA, the pass voltage also is higher in the ON state. To set the current through each pass transistor at 15 mA, the pull-up resistor value is calculated as:

$$R_{PU} = \frac{V_{PU(D)} - 0.35 \text{ V}}{0.015 \text{ A}} \quad (\text{eq. 1})$$

The following table summarizes resistor reference voltages and currents at 15 mA, 10 mA, and 3 mA. The resistor values shown in the +10% column or a larger value should be used to ensure that the pass voltage of the transistor would be 350 mV or less. The external driver must be able to sink the total current from the resistors on both sides of the NLA9306 device at 0.175 V, although the 15 mA only applies to current flowing through the NLA9306 device.

Table 9. PULLUP RESISTOR VALUES Calculated for V_{OL} = 0.35 V; assumes output driver V_{OL} = 0.175 V at stated current.

V _{pu(D)}	Pullup Resistor Value (Ω)					
	15 mA		10 mA		3 mA	
	Nominal	+10% (Note 12)	Nominal	+10% ⁽¹⁾	Nominal	+10% (Note 12)
5 V	310	341	465	512	1550	1705
3.3 V	197	217	295	325	983	1082
2.5 V	143	158	215	237	717	788
1.8 V	97	106	145	160	483	532
1.5 V	77	85	115	127	383	422
1.2 V	57	63	85	94	283	312

12. +10% to compensate for V_{CC} range and resistor tolerance.

Maximum Frequency Calculation

The maximum frequency is totally dependent upon the specifics of the application and the device can operate > 33 MHz. Basically, the NLA9306 behaves like a wire with the additional characteristics of transistor device physics and should be capable of performing at higher frequencies if used correctly.

Here are some guidelines to follow that will help maximize the performance of the device:

- Keep trace length to a minimum by placing the NLA9306 close to the processor.
- The trace length should be less than half the time of flight to reduce ringing and reflections.
- The faster the edge of the signal, the higher the chance for ringing.
- The higher the drive strength (up to 15 mA), the higher the frequency the device can use.

In a 3.3 V to 1.8 V direction level shift, if the 3.3 V side is being driven by a totem pole type driver no pull-up

resistor is needed on the 3.3 V side. The capacitance and line length of concern is on the 1.8 V side since it is driven through the ON resistance of the NLA9306. If the line length on the 1.8 V side is long enough there can be a reflection at the chip/terminating end of the wire when the transition time is shorter than the time of flight of the wire because the NLA9306 looks like a high-impedance compared to the wire. If the wire is not too long and the lumped capacitance is not excessive the signal will only be slightly degraded by the series resistance added by passing through the NLA9306. If the lumped capacitance is large the rise time will deteriorate, the fall time is much less affected and if the rise time is slowed down too much the duty cycle of the clock will be degraded and at some point the clock will no longer be useful. So the principle design consideration is to minimize the wire length and the capacitance on the 1.8 V side for the clock path. A pull-up resistor on the 1.8 V side can also be used to trade a slower fall time for a faster rise time and can also reduce the overshoot in some cases.

NLA9306

ORDERING INFORMATION

Device	Marking	Pin 1 Orientation (See below)	Package	Shipping [†]
NLA9306MUQ1TCG	AY	Q4	UQFN8 (Pb-Free)	3000 / Tape & Reel
NLA9306MUQ1TCG-Q*	AY	Q4	UQFN8 (Pb-Free)	3000 / Tape & Reel
NLA9306MU3TAG	D	Q1	UDFN8 (Pb-Free)	3000 / Tape & Reel
NLA9306MU3TCG	D	Q4	UDFN8 (Pb-Free)	3000 / Tape & Reel
NLA9306USG	A5	Q4	US8 (Pb-Free)	3000 / Tape & Reel
NLA9306USG-Q*	A5	Q4	US8 (Pb-Free)	3000 / Tape & Reel
NLA9306DTR2G	AAF	Q1	TSSOP-8 (Pb-Free)	4000 / Tape & Reel
NLA9306DTR2G-Q*	AAF	Q1	TSSOP-8 (Pb-Free)	4000 / Tape & Reel

[†]For information on tape and reel specifications, including part orientation and tape sizes, please refer to our Tape and Reel Packaging Specifications Brochure, BRD8011/D.

*-Q Suffix for Automotive and Other Applications Requiring Unique Site and Control Change Requirements; AEC-Q100 Qualified and PPAP Capable.

Pin 1 Orientation in Tape and Reel

Direction of Feed

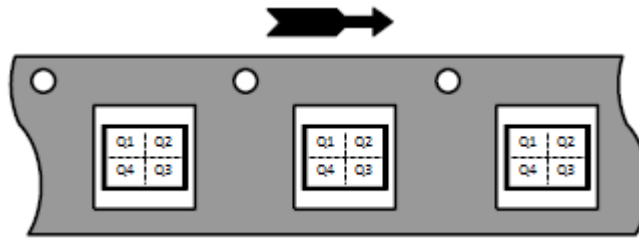

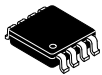

SCALE 4:1

US8
CASE 493
ISSUE F

DATE 01 SEP 2021

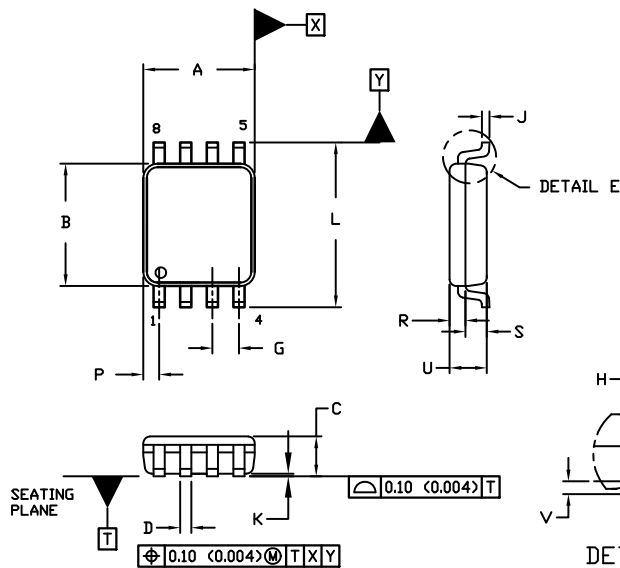

NOTES:

1. DIMENSIONING AND TOLERANCING PER ANSI Y14.5M, 1982.
2. CONTROLLING DIMENSION: MILLIMETERS
3. DIMENSION A DOES NOT INCLUDE MOLD FLASH, PROTRUSION, OR GATE BURR. MOLD FLASH, PROTRUSION, OR GATE BURR SHALL NOT EXCEED 0.14 (0.0055") PER SIDE.
4. DIMENSION B DOES NOT INCLUDE INTERLEAD FLASH OR PROTRUSION. INTERLEAD FLASH AND PROTRUSION SHALL NOT EXCEED 0.14 (0.0055") PER SIDE.
5. LEAD FINISH IS SOLDER PLATING WITH THICKNESS OF 0.0076-0.0203 MM (0.003-0.008").
6. ALL TOLERANCE UNLESS OTHERWISE SPECIFIED ±0.0508 MM (0.002").

DIM	MILLIMETERS		INCHES	
	MIN.	MAX.	MIN.	MAX.
A	1.90	2.10	0.075	0.083
B	2.20	2.40	0.087	0.094
C	0.60	0.90	0.024	0.035
D	0.17	0.25	0.007	0.010
F	0.20	0.35	0.008	0.014
G	0.50 BSC		0.020 BSC	
H	0.40 REF		0.016 REF	
J	0.10	0.18	0.004	0.007
K	0.00	0.10	0.000	0.004
L	3.00	3.25	0.118	0.128
M	0°	6°	0°	6°
N	0°	10°	0°	10°
P	0.23	0.34	0.010	0.013
R	0.23	0.33	0.009	0.013
S	0.37	0.47	0.015	0.019
U	0.60	0.80	0.024	0.031
V	0.12 BSC		0.005 BSC	

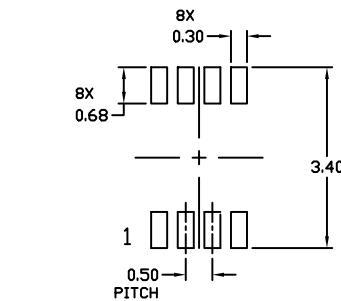

RECOMMENDED *
MOUNTING FOOTPRINT

* For additional information on our Pb-Free strategy and soldering details, please download the DN Semiconductor Soldering and Mounting Techniques Reference Manual, SOLDERM/D.

GENERIC
MARKING DIAGRAM*

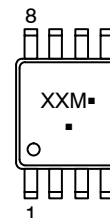

- XX = Specific Device Code
- M = Date Code
- = Pb-Free Package

(Note: Microdot may be in either location)

*This information is generic. Please refer to device data sheet for actual part marking. Pb-Free indicator, "G" or microdot "•", may or may not be present. Some products may not follow the Generic Marking.

DOCUMENT NUMBER:	98AON04475D	Electronic versions are uncontrolled except when accessed directly from the Document Repository. Printed versions are uncontrolled except when stamped "CONTROLLED COPY" in red.
DESCRIPTION:	US8	PAGE 1 OF 1

onsemi and ONSEMI are trademarks of Semiconductor Components Industries, LLC dba onsemi or its subsidiaries in the United States and/or other countries. onsemi reserves the right to make changes without further notice to any products herein. onsemi makes no warranty, representation or guarantee regarding the suitability of its products for any particular purpose, nor does onsemi assume any liability arising out of the application or use of any product or circuit, and specifically disclaims any and all liability, including without limitation special, consequential or incidental damages. onsemi does not convey any license under its patent rights nor the rights of others.



UDFN8, 1.45x1.00, 0.35P
CASE 517BZ
ISSUE O

SCALE 4:1

DATE 18 MAY 2011

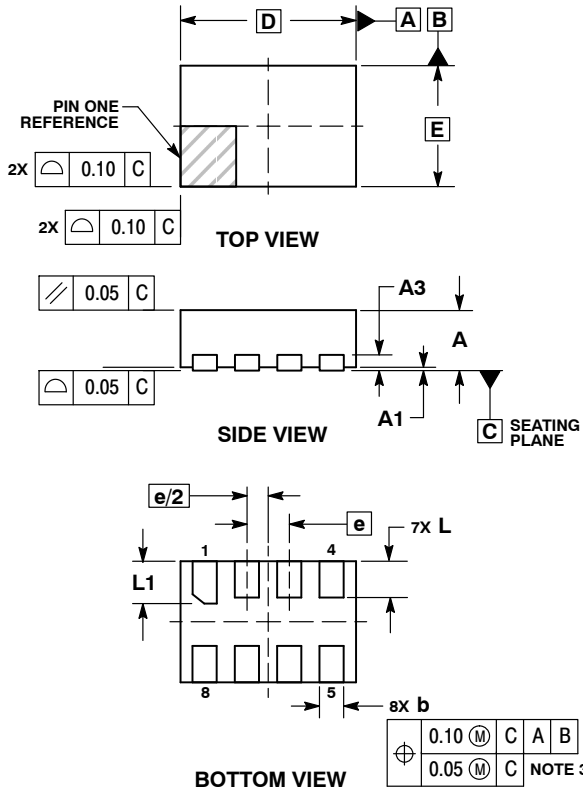

- NOTES:
1. DIMENSIONING AND TOLERANCING PER ASME Y14.5M, 1994.
 2. CONTROLLING DIMENSION: MILLIMETERS.
 3. DIMENSION b APPLIES TO PLATED TERMINAL AND IS MEASURED BETWEEN 0.15 AND 0.20 MM FROM TERMINAL TIP.
 4. PACKAGE DIMENSIONS EXCLUSIVE OF BURRS AND MOLD FLASH.

MILLIMETERS		
DIM	MIN	MAX
A	0.45	0.55
A1	0.00	0.05
A3	0.13	REF
b	0.15	0.25
D	1.45	BSC
E	1.00	BSC
e	0.35	BSC
L	0.25	0.35
L1	0.30	0.40

RECOMMENDED
SOLDERING FOOTPRINT*

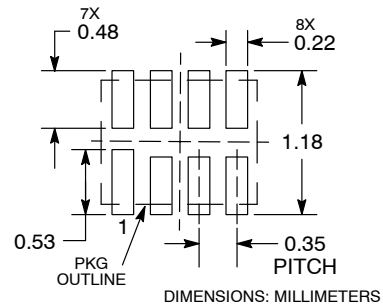

*For additional information on our Pb-Free strategy and soldering details, please download the onsemi Soldering and Mounting Techniques Reference Manual, SOLDERRM/D.

GENERIC
MARKING DIAGRAM*

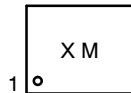

X = Specific Device Code
M = Date Code

*This information is generic. Please refer to device data sheet for actual part marking. Pb-Free indicator, "G" or microdot "μ", may or may not be present. Some products may not follow the Generic Marking.

DOCUMENT NUMBER:	98AON56796E	Electronic versions are uncontrolled except when accessed directly from the Document Repository. Printed versions are uncontrolled except when stamped "CONTROLLED COPY" in red.
DESCRIPTION:	UDFN8, 1.45X1, 0.35P	PAGE 1 OF 1

onsemi and ONSEMI are trademarks of Semiconductor Components Industries, LLC dba onsemi or its subsidiaries in the United States and/or other countries. onsemi reserves the right to make changes without further notice to any products herein. onsemi makes no warranty, representation or guarantee regarding the suitability of its products for any particular purpose, nor does onsemi assume any liability arising out of the application or use of any product or circuit, and specifically disclaims any and all liability, including without limitation special, consequential or incidental damages. onsemi does not convey any license under its patent rights nor the rights of others.



SCALE 4:1

UQFN8, 1.60x1.60, 0.50P
CASE 523AN
ISSUE O

DATE 26 NOV 2008

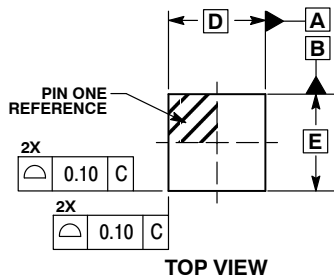

TOP VIEW

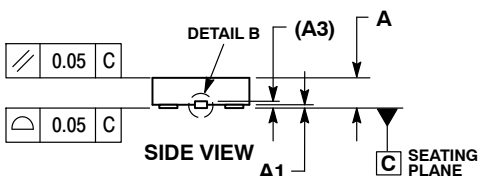

SIDE VIEW

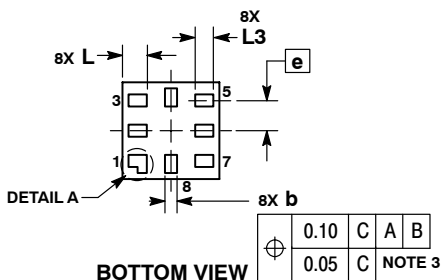

BOTTOM VIEW

\oplus	0.10	C	A	B
	0.05	C		

NOTE 3

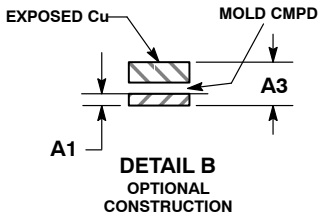

DETAIL B
OPTIONAL
CONSTRUCTION

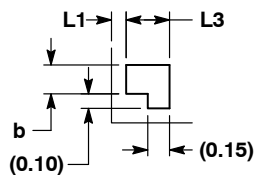

DETAIL A
OPTIONAL
CONSTRUCTION

NOTES:

1. DIMENSIONING AND TOLERANCING PER ASME Y14.5M, 1994.
2. CONTROLLING DIMENSION: MILLIMETERS.
3. DIMENSION b APPLIES TO PLATED TERMINAL AND IS MEASURED BETWEEN 0.15 AND 0.30 mm FROM THE TERMINAL TIP.

MILLIMETERS		
DIM	MIN	MAX
A	0.45	0.60
A1	0.00	0.05
A3	0.13	REF
b	0.15	0.25
D	1.60	BSC
E	1.60	BSC
e	0.50	BSC
L	0.35	0.45
L1	---	0.15
L3	0.25	0.35

SOLDERING FOOTPRINT*

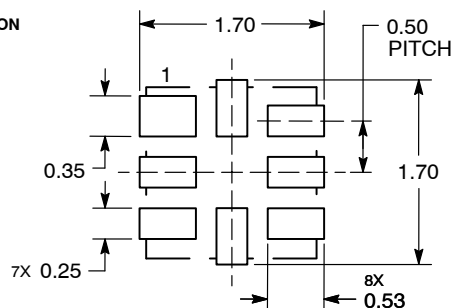

DIMENSIONS: MILLIMETERS

*For additional information on our Pb-Free strategy and soldering details, please download the onsemi Soldering and Mounting Techniques Reference Manual, SOLDERRM/D.

GENERIC MARKING DIAGRAM*

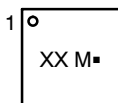

- XX = Specific Device Code
- M = Date Code
- = Pb-Free Package

*This information is generic. Please refer to device data sheet for actual part marking. Pb-Free indicator, "G" or microdot "▪", may or may not be present. Some products may not follow the Generic Marking.

DOCUMENT NUMBER:	98AON36348E	Electronic versions are uncontrolled except when accessed directly from the Document Repository. Printed versions are uncontrolled except when stamped "CONTROLLED COPY" in red.
DESCRIPTION:	UQFN8, 1.60X1.60, 0.50P	PAGE 1 OF 1

onsemi and ONSEMI are trademarks of Semiconductor Components Industries, LLC dba onsemi or its subsidiaries in the United States and/or other countries. onsemi reserves the right to make changes without further notice to any products herein. onsemi makes no warranty, representation or guarantee regarding the suitability of its products for any particular purpose, nor does onsemi assume any liability arising out of the application or use of any product or circuit, and specifically disclaims any and all liability, including without limitation special, consequential or incidental damages. onsemi does not convey any license under its patent rights nor the rights of others.

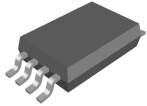

TSSOP8, 4.4x3.0, 0.65P
CASE 948AL
ISSUE A

DATE 20 MAY 2022

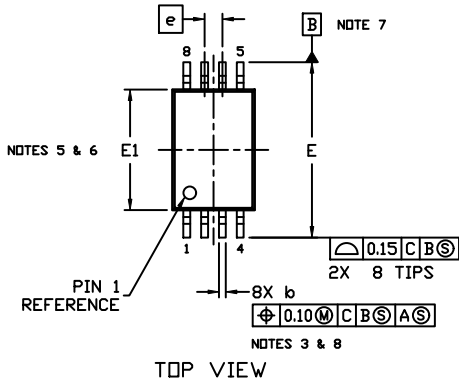

TOP VIEW

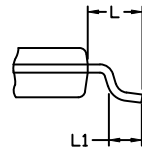

DETAIL A

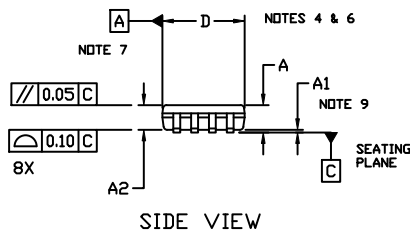

SIDE VIEW

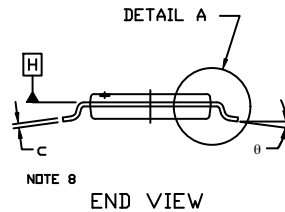

END VIEW

NOTES:

1. DIMENSIONING AND TOLERANCING PER ASME Y14.5, 2009.
2. CONTROLLING DIMENSION: MILLIMETERS
3. DIMENSION b DOES NOT INCLUDE DAMBAR PROTRUSION. ALLOWABLE PROTRUSION SHALL NOT BE 0.15 IN EXCESS OF MAXIMUM MATERIAL CONDITION.
4. DIMENSION D DOES NOT INCLUDE MOLD FLASH, PROTRUSIONS OR GATE BURRS. MOLD FLASH, PROTRUSIONS OR GATE BURRS SHALL NOT EXCEED 0.15 PER SIDE.
5. DIMENSION E1 DOES NOT INCLUDE INTERLEAD FLASH OR PROTRUSION. INTERLEAD FLASH OR PROTRUSION SHALL NOT EXCEED 0.25 PER SIDE.
6. THE PACKAGE TOP MAY BE SMALLER THAN THE PACKAGE BOTTOM. DIMENSIONS D AND E1 ARE DETERMINED AT THE OUTERMOST EXTREMES OF THE PLASTIC BODY AT DATUM PLANE H.
7. DATUMS A AND B ARE TO BE DETERMINED AT DATUM H.
8. DIMENSIONS b AND c APPLY TO THE FLAT SECTION OF THE LEAD BETWEEN 0.10 AND 0.25 FROM THE LEAD TIP.
9. A1 IS DEFINED AS THE LOWEST VERTICAL DISTANCE FROM THE SEATING PLANE TO THE LOWEST POINT ON THE PACKAGE BODY.

DIM	MILLIMETERS		
	MIN.	NDM.	MAX.
A	---	---	1.20
A1	0.05	---	0.15
A2	0.80	0.90	1.05
b	0.19	---	0.30
c	0.09	---	0.20
D	2.90	3.00	3.10
E	6.30	6.40	6.50
E1	4.30	4.40	4.50
e	0.65 BSC		
L	1.00 REF		
L1	0.50	0.60	0.70
θ	0°	---	8°

GENERIC MARKING DIAGRAM*

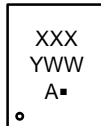

- XXX = Specific Device Code
- Y = Year
- WW = Work Week
- A = Assembly Location
- = Pb-Free Package

*This information is generic. Please refer to device data sheet for actual part marking. Pb-Free indicator, "G" or microdot "▪", may or may not be present. Some products may not follow the Generic Marking.

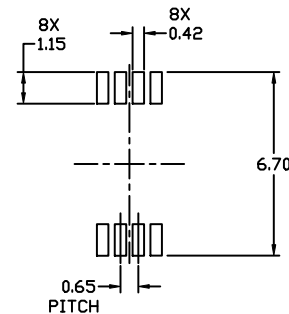

RECOMMENDED MOUNTING FOOTPRINT*

* For additional information on our Pb-Free strategy and soldering details, please download the ON Semiconductor Soldering and Mounting Techniques Reference Manual, SOLDERM/D.

DOCUMENT NUMBER:	98AON34428E	Electronic versions are uncontrolled except when accessed directly from the Document Repository. Printed versions are uncontrolled except when stamped "CONTROLLED COPY" in red.
DESCRIPTION:	TSSOP8, 4.4X3.0, 0.65P	PAGE 1 OF 1

onsemi and ONSEMI are trademarks of Semiconductor Components Industries, LLC dba onsemi or its subsidiaries in the United States and/or other countries. onsemi reserves the right to make changes without further notice to any products herein. onsemi makes no warranty, representation or guarantee regarding the suitability of its products for any particular purpose, nor does onsemi assume any liability arising out of the application or use of any product or circuit, and specifically disclaims any and all liability, including without limitation special, consequential or incidental damages. onsemi does not convey any license under its patent rights nor the rights of others.

onsemi, **Onsemi**, and other names, marks, and brands are registered and/or common law trademarks of Semiconductor Components Industries, LLC dba "**onsemi**" or its affiliates and/or subsidiaries in the United States and/or other countries. **onsemi** owns the rights to a number of patents, trademarks, copyrights, trade secrets, and other intellectual property. A listing of **onsemi**'s product/patent coverage may be accessed at www.onsemi.com/site/pdf/Patent-Marking.pdf. **onsemi** reserves the right to make changes at any time to any products or information herein, without notice. The information herein is provided "as-is" and **onsemi** makes no warranty, representation or guarantee regarding the accuracy of the information, product features, availability, functionality, or suitability of its products for any particular purpose, nor does **onsemi** assume any liability arising out of the application or use of any product or circuit, and specifically disclaims any and all liability, including without limitation special, consequential or incidental damages. Buyer is responsible for its products and applications using **onsemi** products, including compliance with all laws, regulations and safety requirements or standards, regardless of any support or applications information provided by **onsemi**. "Typical" parameters which may be provided in **onsemi** data sheets and/or specifications can and do vary in different applications and actual performance may vary over time. All operating parameters, including "Typicals" must be validated for each customer application by customer's technical experts. **onsemi** does not convey any license under any of its intellectual property rights nor the rights of others. **onsemi** products are not designed, intended, or authorized for use as a critical component in life support systems or any FDA Class 3 medical devices or medical devices with a same or similar classification in a foreign jurisdiction or any devices intended for implantation in the human body. Should Buyer purchase or use **onsemi** products for any such unintended or unauthorized application, Buyer shall indemnify and hold **onsemi** and its officers, employees, subsidiaries, affiliates, and distributors harmless against all claims, costs, damages, and expenses, and reasonable attorney fees arising out of, directly or indirectly, any claim of personal injury or death associated with such unintended or unauthorized use, even if such claim alleges that **onsemi** was negligent regarding the design or manufacture of the part. **onsemi** is an Equal Opportunity/Affirmative Action Employer. This literature is subject to all applicable copyright laws and is not for resale in any manner.

ADDITIONAL INFORMATION

TECHNICAL PUBLICATIONS:

Technical Library: www.onsemi.com/design/resources/technical-documentation
onsemi Website: www.onsemi.com

ONLINE SUPPORT: www.onsemi.com/support

For additional information, please contact your local Sales Representative at www.onsemi.com/support/sales