

FLEXMOS™ Hex Low-side MOSFET Pre-driver

NCV7520

The NCV7520 programmable six channel low-side MOSFET pre-driver is one of a family of FLEXMOS automotive grade products for driving logic-level MOSFETs. The product is controllable by a combination of serial SPI and parallel inputs. The device offers 3.3 V/ 5 V compatible inputs and the serial output driver can be powered from either 3.3 V or 5 V. An internal power-on reset provides controlled power up. A reset input allows external re-initialization and an enable input allows all outputs and diagnostics to be simultaneously disabled.

Each channel independently monitors its external MOSFET's drain voltage for fault conditions. Shorted load fault detection thresholds are fully programmable using an externally programmed reference voltage and a combination of discrete internal ratio values. The ratio values are SPI selectable and allow different detection thresholds for each channel.

Fault recovery operation for each channel is programmable and may be selected for latch-off or automatic retry. Status information for each channel is 3-bit encoded by fault type and is available through SPI communication.

The FLEXMOS family of products offers application scalability through choice of external MOSFETs.

Features

- 16-bit SPI with Parity and Frame Error Detection
- 3.3 V/5 V Compatible Parallel and Serial Control Inputs
- 3.3 V/5 V Compatible Serial Output Driver
- Reset and Enable Inputs
- Open-drain Fault Flag
- Priority Encoded Diagnostics with Unique Fault Type Data
 - ◆ On-state: Shorted Load, Driver Latched Off
 - ◆ Off-state: Short to GND, Open Load
 - ◆ On and Off State Pulsed Mode Diagnostics
- Ratiometric Diagnostic References and Currents
- Programmable
 - ◆ Shorted Load Fault Detection Thresholds
 - ◆ Fault Recovery Mode
 - ◆ Blanking Timers
- Wettable Flanks Pb-Free Packaging
- Commercial Vehicle Capable
- NCV Prefix for Automotive and Other Applications Requiring Unique Site and Control Change Requirements; AEC-Q100 Qualified and PPAP Capable
- This is a Pb-Free Device

Benefits

- Scalable to Load by Choice of External MOSFET

MARKING DIAGRAMS

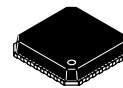

QFN32
MW SUFFIX
CASE 485CZ

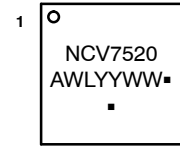

TQFP32 EP
FP SUFFIX
CASE 136AB

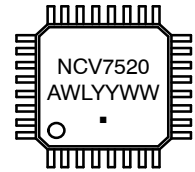

- A = Assembly Location
- WL = Wafer Lot
- YY = Year
- WW = Work Week
- = Pb-Free Package

(Note: Microdot may be in either location)

ORDERING INFORMATION

Device	Package	Shipping†
NCV7520MWTXG	QFN32 (Pb-Free)	5000 / Tape & Reel

DISCONTINUED (Note 1)

Device	Package	Shipping†
NCV7520FPR2G	TQFP32 (Pb-Free)	3000 / Tape & Reel

† For information on tape and reel specifications, including part orientation and tape sizes, please refer to our Tape and Reel Packaging Specification Brochure, [BRD8011/D](#).

1. **DISCONTINUED:** This device is not available. Please contact your **onsemi** representative for information. The most current information on this device may be available on www.onsemi.com.

NCV7520

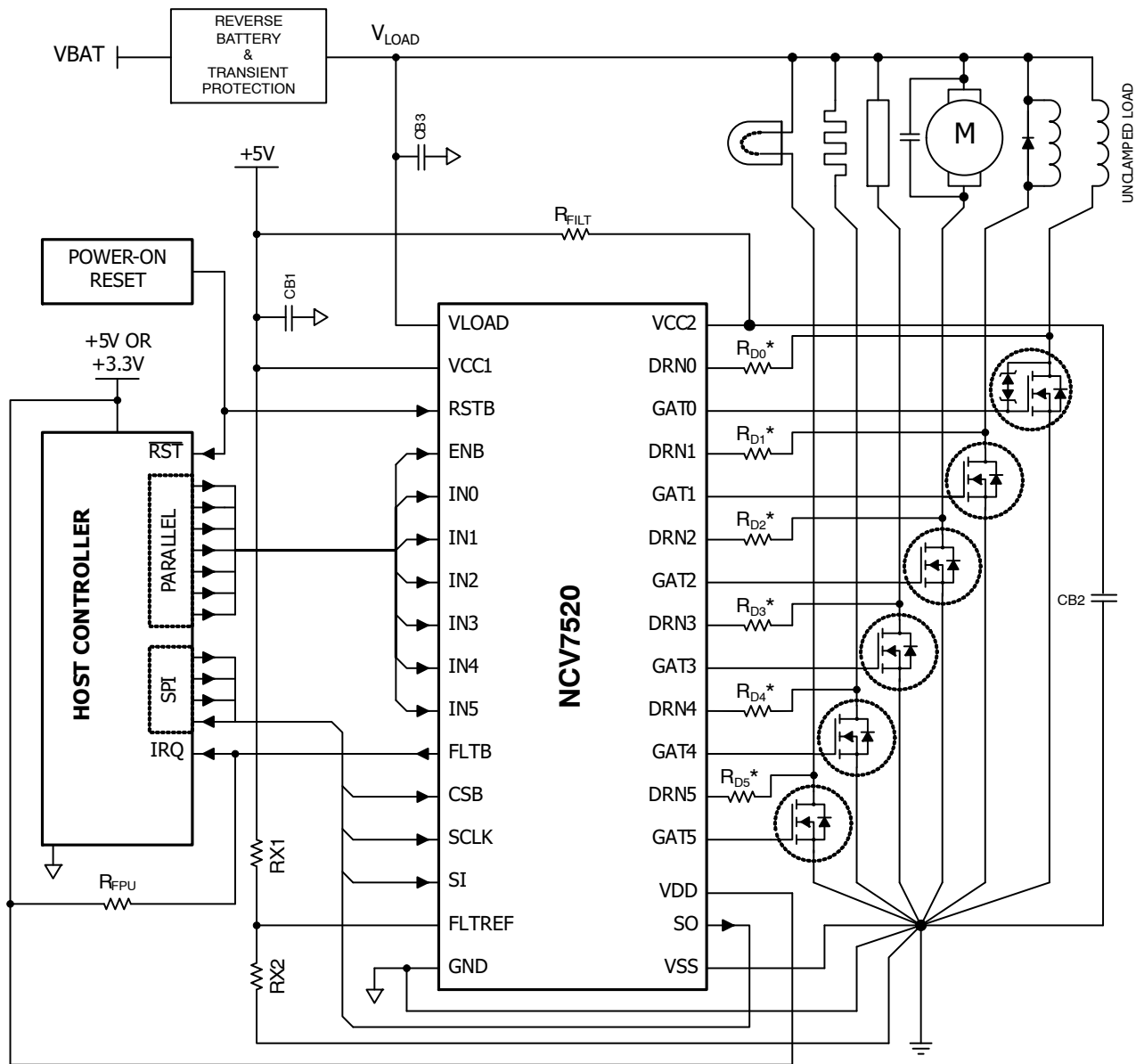

* Optional R_{DX} - See Application Guidelines

Figure 2. Application Diagram

NCV7520

PACKAGE PIN DESCRIPTION 32 PIN QFN EXPOSED PAD PACKAGE

Label	Description
FLTREF	Analog Fault Detect Threshold: 5 V Compliant
DRN0 – DRN5	Analog Drain Feedback
GAT0 – GAT5	Analog Gate Drive: 5 V Compliant
RSTB	Digital Master Reset Input: 3.3 V/5 V (TTL) Compatible
ENB	Digital Master Enable Input: 3.3 V/5 V (TTL) Compatible
IN0 – IN5	Digital Parallel Input: 3.3 V/5 V (TTL) Compatible
CSB	Digital Chip Select Input: 3.3 V/5 V (TTL) Compatible
SCLK	Digital Shift Clock Input: 3.3 V/5 V (TTL) Compatible
SI	Digital Serial Data Input: 3.3 V/5 V (TTL) Compatible
SO	Digital Serial Data Output: 3.3 V/5 V (TTL) Compatible
FLTB	Digital Open-Drain Output: 3.3 V/5 V (TTL) Compatible
VLOAD	Power Supply – Diagnostic References and Currents
VCC1	Power Supply – Low Power Path
GND	Power Return – Low Power Path – Device Substrate
VCC2	Power Supply – Gate Drivers
VDD	Power Supply – Serial Output Driver
VSS	Power Return – VLOAD, VCC2, VDD
EP	Exposed Pad – Connected to GND – Device Substrate

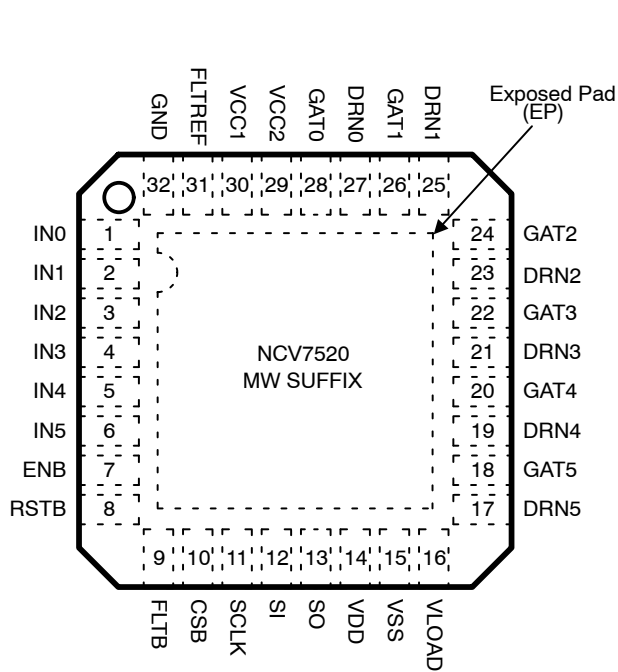

Figure 3. 32 Pin QFN Exposed Pad Pinout (Top View)

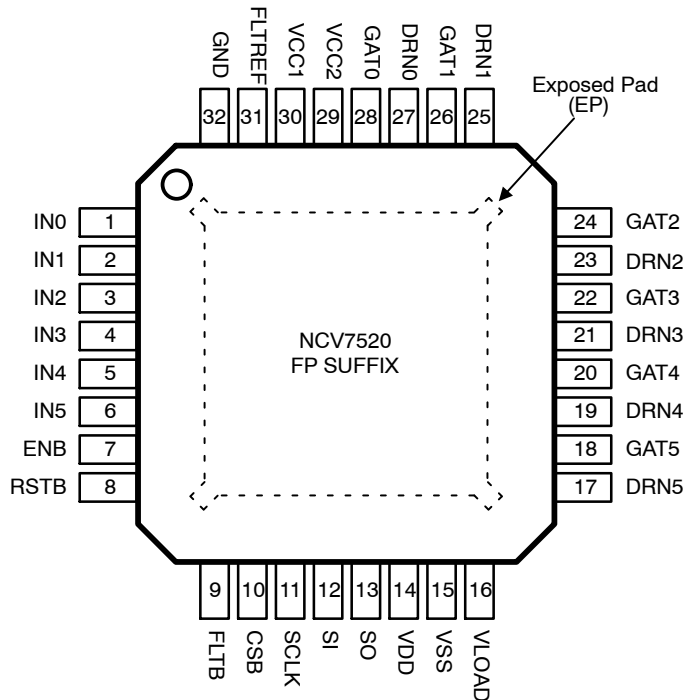

Figure 4. 32 Pin TQFP Exposed Pad Pinout (Top View)

NCV7520

MAXIMUM RATINGS (Voltages are with respect to device substrate.)

Rating	Value	Unit
DC Supply – V_{LOAD}	-0.3 to 48	V
DC Supply – V_{CC1} , V_{CC2} , V_{DD}	-0.3 to 5.8	V
Difference Between V_{CC1} and V_{CC2}	± 0.3	V
Difference Between GND (Substrate) and V_{SS}	± 0.3	V
Drain Input Clamp Forward Voltage Transient (≤ 2 ms, $\leq 1\%$ duty)	78	V
Drain Input Clamp Forward Current Transient (≤ 2 ms, $\leq 1\%$ duty)	10	mA
Drain Input Clamp Energy Repetitive (≤ 2 ms, $\leq 1\%$ duty)	1.56	mJ
Drain Input Clamp Reverse Current $V_{DRNX} \geq -1.0$ V	-50	mA
Input Voltage (Any Input Other Than Drain)	-0.3 to 5.8	V
Output Voltage (Any Output)	-0.3 to 5.8	V
Junction Temperature, T_J	-40 to 150	$^{\circ}\text{C}$
Storage Temperature, T_{STG}	-65 to 150	$^{\circ}\text{C}$
Peak Reflow Soldering Temperature: Lead-free 60 to 150 seconds at 217 $^{\circ}\text{C}$ (Note 2)	260 peak	$^{\circ}\text{C}$

Stresses exceeding those listed in the Maximum Ratings table may damage the device. If any of these limits are exceeded, device functionality should not be assumed, damage may occur and reliability may be affected.

2. See or download **onsemi** Soldering and Mounting Techniques Reference Manual, SOLDERRM/D.

ATTRIBUTES

Characteristic	Conditions	Package	
		QFN32	TQFP32
ESD Capability Human Body Model per AEC-Q100-002	Drain Feedback Pins (Note 4) All Other Pins	$\geq \pm 4.0$ kV $\geq \pm 2.0$ kV	$\geq \pm 4.0$ kV $\geq \pm 2.0$ kV
Moisture Sensitivity	(Note 3)	MSL3	MSL3
Package Thermal Resistance – Still-air Junction-to-Ambient, $R_{\theta JA}$	(Note 5)	62 $^{\circ}\text{C}/\text{W}$	64 $^{\circ}\text{C}/\text{W}$
Junction-to-Exposed Pad, $R_{\Psi JPAD}$	(Note 6)	26 $^{\circ}\text{C}/\text{W}$ 1.8 $^{\circ}\text{C}/\text{W}$	30 $^{\circ}\text{C}/\text{W}$ 5.2 $^{\circ}\text{C}/\text{W}$

3. See or download **onsemi**'s Soldering and Mounting Techniques Reference Manual, SOLDERRM/D.

4. With GND & V_{SS} pins tied together – path between drain feedback pins and GND, or between drain feedback pins.

5. 2S0P 2-layer PCB based on JESD51-3, 80 x 80 x 1.6 mm FR4, 20 thermal vias, 2 oz. Signal, 2 oz. 400 mm² bottom spreader.

6. 2S2P 4-layer PCB based on JESD51-7, 80 x 80 x 1.6 mm FR4, 20 thermal vias, 2 oz. Signal, 1 oz. 6400 mm² internal spreaders.

RECOMMENDED OPERATING CONDITIONS

Symbol	Parameter	Min	Max	Unit
V_{LOAD}	Diagnostic References and Currents Power Supply Voltage	7.5	36.0	V
V_{DRNX}	Drain Input Feedback Voltage	-0.3	60	V
V_{CC1}	Main Power Supply Voltage	4.75	5.25	V
V_{CC2}	Gate Drivers Power Supply Voltage	$V_{CC1} - 0.3$	$V_{CC1} + 0.3$	V
V_{DD}	Serial Output Driver Power Supply Voltage	3.0	V_{CC1}	V
V_{FLTREF}	Fault Detect Threshold Reference Voltage	0.35	2.75	V
V_{IN} High	Logic High Input Voltage	2.0	V_{CC1}	V
V_{IN} Low	Logic Low Input Voltage	0	0.8	V
T_A	Ambient Still-air Operating Temperature	-40	125	$^{\circ}\text{C}$
t_{RESET}	Startup Delay at Power-on Reset (POR) (Note 7)	-	200	μs

Functional operation above the stresses listed in the Recommended Operating Ranges is not implied. Extended exposure to stresses beyond the Recommended Operating Ranges limits may affect device reliability.

7. Minimum wait time until device is ready to accept serial input data.

NCV7520

PARAMETRIC TABLESGN

ELECTRICAL CHARACTERISTICS

($4.75\text{ V} \leq V_{CCX} \leq 5.25\text{ V}$, $V_{DD} = V_{CCX}$, $4.5\text{ V} \leq V_{LOAD} \leq 36\text{ V}$, $RSTB = V_{CCX}$, $ENB = 0$, $-40\text{ }^{\circ}\text{C} \leq T_J \leq 150\text{ }^{\circ}\text{C}$, unless otherwise specified.)
(Note 8)

Characteristic	Symbol	Conditions	Min	Typ	Max	Unit
----------------	--------	------------	-----	-----	-----	------

V_{CC1} SUPPLY

Operating Current – $V_{CC1} = 5.25\text{ V}$, $V_{FLTRF} = 2.75\text{ V}$	I _{CC1A}	RSTB = 0	–	2.80	5.0	mA
	I _{CC1B}	ENB = 0, RSTB = V _{CC1} , V _{DRNX} =0 V, GAT _X Drivers Off	–	3.10	5.0	mA
	I _{CC1C}	ENB = 0, RSTB = V _{CC1} , GAT _X Drivers On	–	2.80	5.0	mA
Power-On Reset Threshold	POR	V _{CC1} Rising	3.65	4.125	4.60	V
Power-On Reset Hysteresis	PORH		0.150	0.385	–	V

V_{CC2} SUPPLY

Operating Current	I _{CC2}	V _{CC2} = 5.25 V, ENB = 0, RSTB = V _{CC1} = 5.25 V V _{DRNX} = 0 V, GAT _X Drivers Off	–	2.80	5.0	mA
-------------------	------------------	---	---	------	-----	----

V_{DD} SUPPLY

Standby Current	I _{DD1}	V _{DD} = 5.25V, ENB = 0, RSTB = V _{CC1} = 5.25 V SO = Z	–	25.0	34.0	μA
Operating Current	I _{DD2}	V _{DD} = 5.25V, ENB = 0, RSTB = V _{CC1} = 5.25 V SO = H or L	–	625	850	μA

V_{LOAD} SUPPLY

Standby Current	V _{LDSBY}	V _{LOAD} = 24 V, $0 \leq V_{CC1} \leq 5.25$, ENB = RSTB = V _{CC1} , T _A ≤ 85 °C	–	–	10	μA
Operating Current	V _{LDOP}	V _{LOAD} = 36 V, ENB = 0, RSTB = V _{CC1} , V _{DRNX} = 0 V	–	22	30	mA

DIGITAL I/O

V _{IN} High	V _{IHX}	RSTB, ENB, IN _X , SI, SCLK, CSB	2.0	–	–	V
V _{IN} Low	V _{ILX}	RSTB, ENB, IN _X , SI, SCLK, CSB	–	–	0.8	V
V _{IN} Hysteresis	IN _{HY}	RSTB, ENB, IN _X , SI, SCLK, CSB	100	330	500	mV
Input Pullup Resistance	R _{PUX}	ENB, CSB, V _{IN} = 0 V	50	125	200	kΩ
Input Pulldown Resistance	R _{PDX}	RSTB, IN _X , SI, SCLK, V _{IN} = V _{CC1}	50	125	200	kΩ
SO Low Voltage	V _{SOL}	V _{DD} = 3.0 V, I _{SINK} = 2 mA	–	–	0.4	V
SO High Voltage	V _{SOH}	V _{DD} = 3.0 V, I _{SOURCE} = 2 mA	V _{DD} – 0.6	–	–	V
SO Output Resistance	R _{SO}	Output High or Low	–	25	–	Ω
SO Tri-State Leakage Current	SO _{LKG}	CSB = 3.0 V	–5.0	–	5.0	μA
FLT _B Low Voltage	V _{FLTB}	FLT _B Active, I _{FLTB} = 1.25 mA	–	–	0.4	V
FLT _B Leakage Current	I _{FLTLKG}	V _{FLTB} = V _{CC1}	–	–	10	μA
RSTB Assert Time	t _{WRST}	t _{ASSERT} < t _{WRST} (MIN) guaranteed to be rejected t _{ASSERT} > t _{WRST} (MAX) guaranteed to be accepted	1.0	–	2.5	μs

Product parametric performance is indicated in the Electrical Characteristics for the listed test conditions, unless otherwise noted. Product performance may not be indicated by the Electrical Characteristics if operated under different conditions.

- Min/Max values are valid for the temperature range $-40\text{ }^{\circ}\text{C} \leq T_J \leq 150\text{ }^{\circ}\text{C}$ unless noted otherwise. Min/Max values are guaranteed by test, design or statistical correlation.
- Guaranteed by design.

NCV7520

ELECTRICAL CHARACTERISTICS (continued)

(4.75 V ≤ V_{CCX} ≤ 5.25 V, V_{DD} = V_{CCX}, 4.5 V ≤ V_{LOAD} ≤ 36 V, RSTB = V_{CCX}, ENB = 0, -40 °C ≤ T_J ≤ 150 °C, unless otherwise specified.)
(Note 8)

Characteristic	Symbol	Conditions	Min	Typ	Max	Unit
----------------	--------	------------	-----	-----	-----	------

FAULT DETECTION – GATX ON

FLTREF Input Current	I _{FLTREF}	0 V ≤ V _{FLTREF} ≤ 2.75 V	-1.0	-	1.0	μA
FLTREF Input Linear Range	V _{REFLIN}	(Note 9)	0.35	-	2.75	V
FLTREF Op-amp V _{CC1} PSRR	PSRR	(Note 9)	30	-	-	dB
DRN _X Shorted Load Threshold V _{FLTREF} = 0.35 V	V ₂₅	Register R2.C[11:9] = 000 (DEFAULT)	20	25	30	% V _{FLTREF}
	V ₄₀	Register R2.C[11:9] = 001	35	40	45	
	V ₅₀	Register R2.C[11:9] = 010	45	50	55	
	V ₆₀	Register R2.C[11:9] = 011	55	60	65	
	V ₇₀	Register R2.C[11:9] = 100	65	70	75	
	V ₈₀	Register R2.C[11:9] = 101	75	80	85	
	V ₉₀	Register R2.C[11:9] = 110	85	90	95	
	V ₁₀₀	Register R2.C[11:9] = 111	95	100	105	
DRN _X Input Leakage Current	ID _{LKG}	0 V ≤ V _{CC1} = V _{CC2} = V _{DD} ≤ 5.25 V, RSTB = 0 V, V _{LOAD} = V _{DRNX} = 36 V T _A ≤ 25 °C	-5.0 -1.0	- -	5.0 1.0	μA
DRN _X Clamp Voltage	V _{CL}	I _{DRNX} = I _{CL(MAX)} = 10 mA; Transient (≤ 2 ms, ≤ 1% Duty)	60	-	78	V

FAULT DETECTION – GATX OFF (7.5 V ≤ V_{LOAD} ≤ 36 V, Register R3.D[5:0] = 1)

DRN _X Diagnostic Current – Proportional to V _{LOAD}	I _{SG}	Short to GND Detection, V _{DRNX} = 43%V _{LOAD}	-81	-60	-39	μA / V
	I _{OL}	Open Load Detection, V _{DRNX} = 61%V _{LOAD}	2.73	4.20	5.67	μA / V
DRN _X Fault Threshold Voltage	V _{SG}	Short to GND Detection	39.56	43	46.44	%V _{LOAD}
	V _{OL}	Open Load Detection	56.12	61	65.88	%V _{LOAD}
DRN _X Off State Bias Voltage	V _{CTR}		46.92	51	55.08	%V _{LOAD}
VLOAD Undervoltage Threshold	V _{LDUV}	VLOAD Decreasing	4.1	6.3	7.5	V

FAULT TIMERS

Channel Fault Blanking Timers (Figure 7)	t _{BL(ON)}	V _{DRNX} = V _{LOAD} ; IN _X rising to FLT falling Register R2.C[4] = 0, R2.C[6:5] = 00	4.6	6.0	7.4	μs
		Register R2.C[4] = 0, R2.C[6:5] = 01	9.2	12.0	14.8	
		Register R2.C[4] = 0, R2.C[6:5] = 10 (DEFAULT)	20.0	26.0	32.0	
		Register R2.C[4] = 0, R2.C[6:5] = 11	40.0	52.0	64.0	
	t _{BL(OFF)}	V _{DRNX} = V _{LOAD} ; IN _X rising to FLT falling Register R2.C[4] = 1, R2.C[6:5] = 00	13.0	16.9	20.8	μs
		Register R2.C[4] = 1, R2.C[6:5] = 01	25.0	32.5	39.9	
		Register R2.C[4] = 1, R2.C[6:5] = 10	60.0	77.9	95.8	
		Register R2.C[4] = 1, R2.C[6:5] = 11	98.0	127.3	156.5	
	t _{BL(OFF)}	V _{DRNX} = 0V; IN _X falling to FLT falling Register R2.C[8:7] = 00	42.4	55.0	67.6	μs
		Register R2.C[8:7] = 01	61.6	80.0	98.4	
		Register R2.C[8:7] = 10 (DEFAULT)	123.2	160.0	196.8	
		Register R2.C[8:7] = 11	246.4	320.0	393.6	
Channel Fault Filter Timer	t _{FF(ON)}	(Figure 7)	2.0	3.0	4.0	μs
	t _{FF(OFF)}		42.4	55.0	67.6	
Channel Fault Retry Timer	t _{FR}	Register R0.M[5:0] = 1 (Figure 8)	6.0	8.0	10	ms
Timer Clock	f _{CLK}	RSTB = V _{CC1}	-	12.5	-	MHz

Product parametric performance is indicated in the Electrical Characteristics for the listed test conditions, unless otherwise noted. Product performance may not be indicated by the Electrical Characteristics if operated under different conditions.

8. Min/Max values are valid for the temperature range -40 °C ≤ T_J ≤ 150 °C unless noted otherwise. Min/Max values are guaranteed by test, design or statistical correlation.
9. Guaranteed by design.

NCV7520

ELECTRICAL CHARACTERISTICS (continued)

($4.75\text{ V} \leq V_{CCX} \leq 5.25\text{ V}$, $V_{DD} = V_{CCX}$, $4.5\text{ V} \leq V_{LOAD} \leq 36\text{ V}$, $R_{STB} = V_{CCX}$, $ENB = 0$, $-40\text{ }^\circ\text{C} \leq T_J \leq 150\text{ }^\circ\text{C}$, unless otherwise specified.)
(Note 8)

Characteristic	Symbol	Conditions	Min	Typ	Max	Unit
GATE DRIVER OUTPUTS						
GAT _X Output Resistance	R _{GATX}	Output High or Low	200	350	500	Ω
GAT _X High Output Current	I _{GSR}	V _{GATX} = 0 V	-26.25	-	-9.5	mA
GAT _X Low Output Current	I _{GSN}	V _{GATX} = V _{CC2}	9.5	-	26.25	mA
Turn-On Propagation Delay	t _{P(ON)}	IN _X to GAT _X (Figure 5)	-	-	1.0	μs
		CSB to GAT _X (Figure 6)	-	-	2.0	
Turn-Off Propagation Delay	t _{P(OFF)}	IN _X to GAT _X (Figure 5)	-	-	1.0	μs
		CSB to GAT _X (Figure 6)	-	-	2.0	
Output Rise Time	t _R	20% to 80% of V _{CC2} , C _{LOAD} = 400 pF (Figure 5, Note 9)	-	-	277	ns
Output Fall Time	t _F	80% to 20% of V _{CC2} , C _{LOAD} = 400 pF (Figure 5, Note 9)	-	-	277	ns

SERIAL PERIPHERAL INTERFACE (Figure 10) V_{CCX} = 5.0 V, V_{DD} = 3.3 V, F_{SCLK} = 4.0 MHz, C_{LOAD} = 200 pF

SO Supply Voltage	V _{DD}	3.3 V Interface	3.0	3.3	3.6	V
		5 V Interface	4.5	5.0	5.5	V
SCLK Clock Period	t _{SCLK}		-	250	-	ns
Maximum Input Capacitance	C _{INX}	SI, SCLK (Note 9)	-	-	12	pF
SCLK High Time	t _{CLKH}	SCLK = 2.0 V to 2.0 V	125	-	-	ns
SCLK Low Time	t _{CLKL}	SCLK = 0.8 V to 0.8 V	125	-	-	ns
SI Setup Time	t _{SISU}	SI = 0.8 V/2.0 V to SCLK = 2.0 V (Note 9)	25	-	-	ns
SI Hold Time	t _{SIHD}	SCLK = 2.0 V to SI = 0.8 V/2.0 V (Note 9)	25	-	-	ns
SO Rise Time	t _{SOR}	(20% V _{SO} to 80% V _{DD}) C _{LOAD} = 200 pF (Note 9)	-	25	50	ns
SO Fall Time	t _{SOF}	(80% V _{SO} to 20% V _{DD}) C _{LOAD} = 200 pF (Note 9)	-	-	50	ns
CSB Setup Time	t _{CSBSU}	CSB = 0.8 V to SCLK = 2.0 V (Note 9)	60	-	-	ns
CSB Hold Time	t _{CSBHD}	SCLK = 0.8 V to CSB = 2.0 V (Note 9)	75	-	-	ns
CSB to SO Time	t _{CS-SO}	CSB = 0.8 V to SO Data Valid (Note 9)	-	65	125	ns
SO Delay Time	SO _{DLY}	SCLK = 0.8 V to SO Data Valid (Note 9)	-	65	125	ns
Transfer Delay Time	CS _{DLY}	CSB Rising Edge to Next Falling Edge (Note 9)	1.8	-	-	μs

Product parametric performance is indicated in the Electrical Characteristics for the listed test conditions, unless otherwise noted. Product performance may not be indicated by the Electrical Characteristics if operated under different conditions.

8. Min/Max values are valid for the temperature range $-40\text{ }^\circ\text{C} \leq T_J \leq 150\text{ }^\circ\text{C}$ unless noted otherwise. Min/Max values are guaranteed by test, design or statistical correlation.
9. Guaranteed by design.

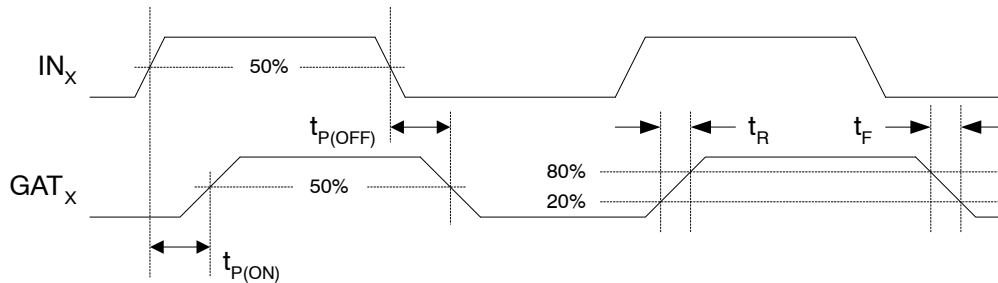

Figure 5. Gate Driver Timing Diagram – Parallel Input

NCV7520

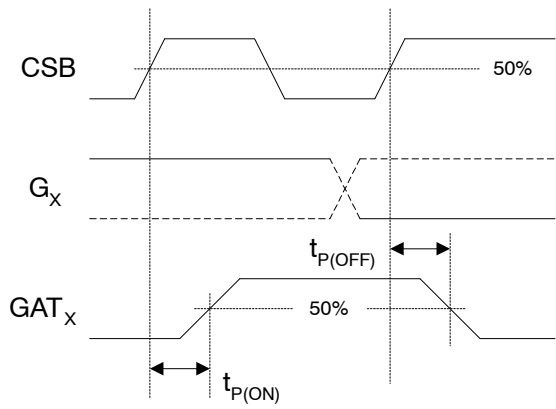

Figure 6. Gate Driver Timing Diagram – Serial Input

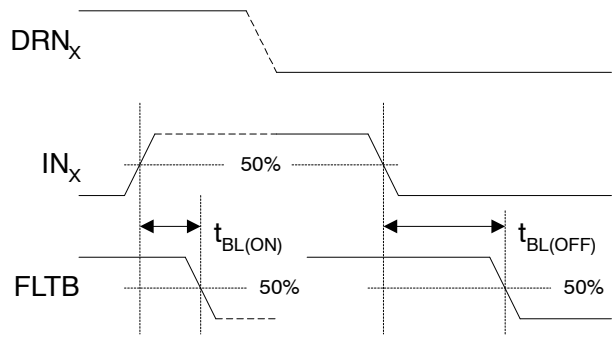

Figure 7. Blanking Timing Diagram

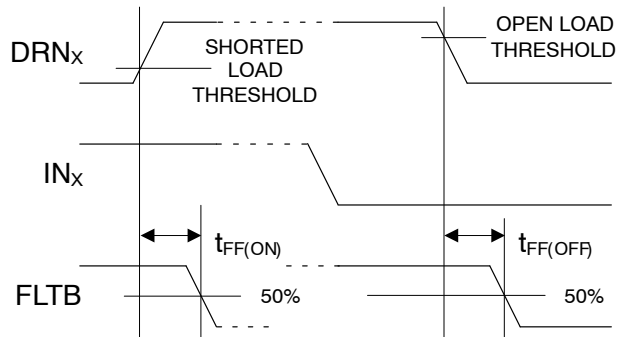

Figure 8. Filter Timing Diagram

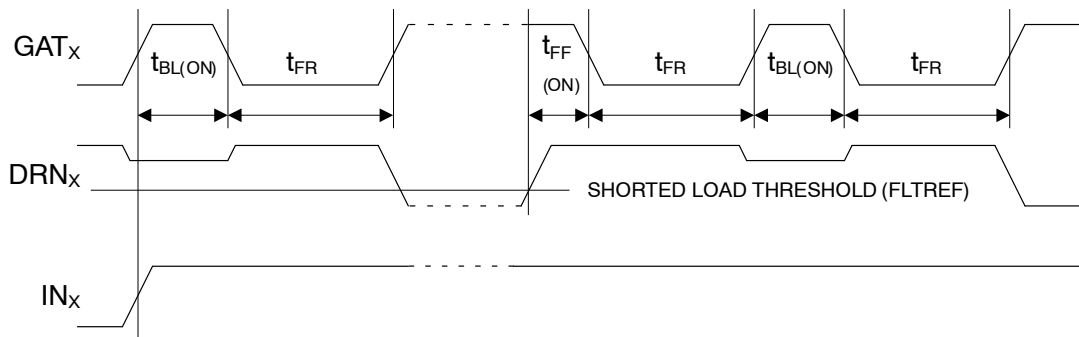
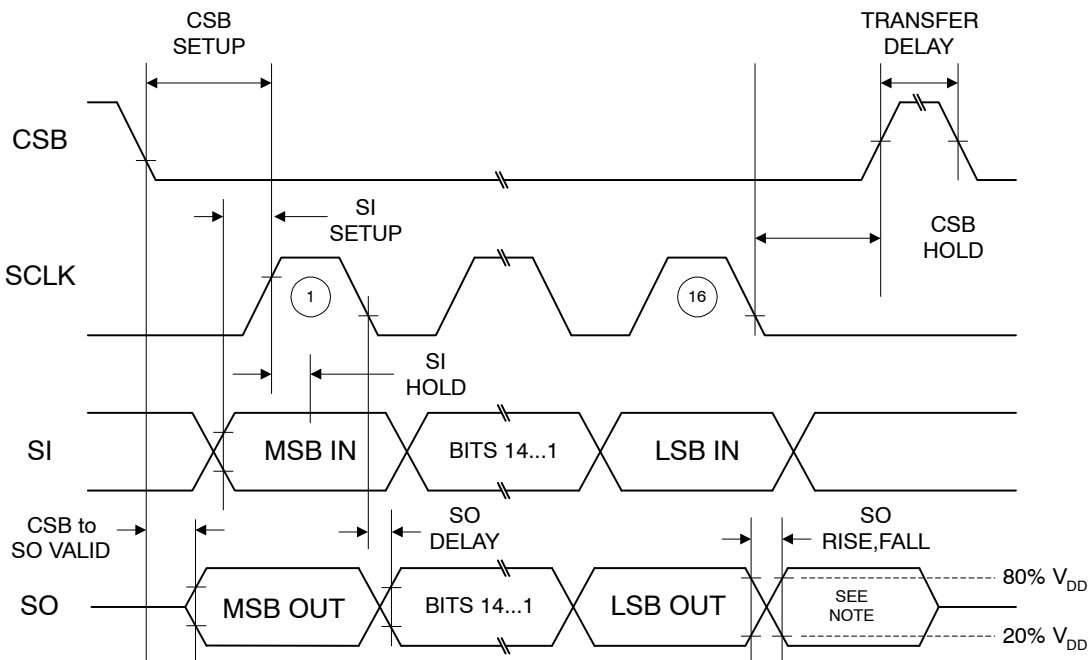

Figure 9. Fault Retry Timing Diagram



Note: Not defined but usually MSB of data just received.

Figure 10. SPI Timing Diagram

DETAILED OPERATING DESCRIPTION

General

The NCV7520 is a six channel general-purpose low-side pre-driver for controlling and protecting N-type logic level MOSFETs. Programmable fault detection and protection modes allow the device to accommodate a wide range of external MOSFETs and loads, providing flexible application solutions. Separate power supply pins are provided for low and high current paths to improve analog accuracy and digital signal integrity.

Power Up/Down Control

An internal Power-On Reset (POR) monitors V_{CC1} and causes all GAT_X outputs to be held low until sufficient voltage is available to allow proper control of the device. All internal registers are initialized to their defaults, status data is cleared, and the open-drain fault flag (FLT_B) is disabled.

When V_{CC1} exceeds the POR threshold, the device is initialized and ready to accept input data. When V_{CC1} falls below the POR threshold during power down, FLT_B is disabled and all GAT_X outputs are driven and held low until V_{CC1} falls below about 1.5 V.

RSTB and ENB Inputs

The active-low RSTB input with a resistive pull-down allows device reset by an external signal. When RSTB is brought low, all GAT_X outputs, the timer clock, the SPI, and the FLT_B flag are disabled. All internal registers are initialized to their default states, status data is cleared, and the SPI and FLT_B are enabled when RSTB goes high.

The active-low ENB input with resistive pull-up provides a global enable. ENB disables all GAT_X outputs and diagnostics, and resets the auto-retry timer when brought high. The SPI is enabled, registers remain as programmed, and status data is not cleared. Latched-off outputs are re-enabled and their status can be updated when ENB goes low.

SPI Communication

The NCV7520 is a 16-bit slave device. Communication between the host and the device may either be parallel via individual CSB addressing or daisy-chained through other devices using a compatible SPI protocol.

The active-low CSB chip select input has a pull-up resistor. The SI and SCLK inputs have pull-down resistors. The recommended idle state for SCLK is low. The tri-state SO line driver is powered via the V_{DD} and the V_{SS} pins, and can be supplied with either 3.3 V or 5 V.

The device employs odd parity, and frame error detection that requires integer multiples of 16 SCLK cycles during each CSB high-low-high cycle (valid communication frame.) A parity or frame error does not affect the FLT_B flag.

The host initiates communication when a selected device's CSB pin goes low. Output data is simultaneously sent MSB first from the SO pin while input data is received MSB first at the SI pin under synchronous control of the master's SCLK signal while CSB is held low (Figure 11). Output data changes on the falling edge of SCLK and is guaranteed valid before the next rising edge of SCLK. Input data received must be valid before the rising edge of SCLK.

NCV7520

When CSB goes low, frame error detection is initialized, output data is transferred to the SPI, and the FLTB flag is disabled and reset if previously set.

If a valid frame has been received when CSB goes high, the last multiple of 16 bits received is decoded into command data, and FLTB is re-enabled. The FLTB flag will be set if a fault is detected.

If a frame or parity error is detected when CSB goes high, new command data is ignored, and previous fault data

remains latched and available for retrieval during the next valid frame. The FLTB flag will be set if a fault (not a frame or parity error) is detected.

The interaction between CSB and FLTB facilitates fault polling. When multiple NCV7520 devices are configured for parallel SPI access with individual CSB addressing, the device reporting a fault can be identified by pulsing each CSB in turn.

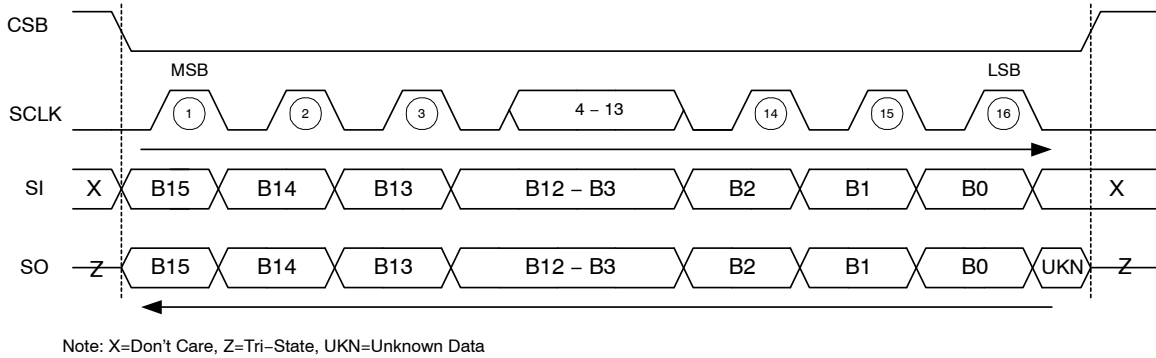

Figure 11. SPI Communication Frame Format

Serial Data and Register Structure

The 16-bit data received by the NCV7520 is decoded into a 3-bit address, a 12-bit data word, and an odd parity bit (Figure 12). The upper three bits, beginning with the received MSB, are fully decoded to address one of eight

registers. The valid register addresses are shown in Table 1. The input command structure is shown in Table 3. Each register is later described in detail.

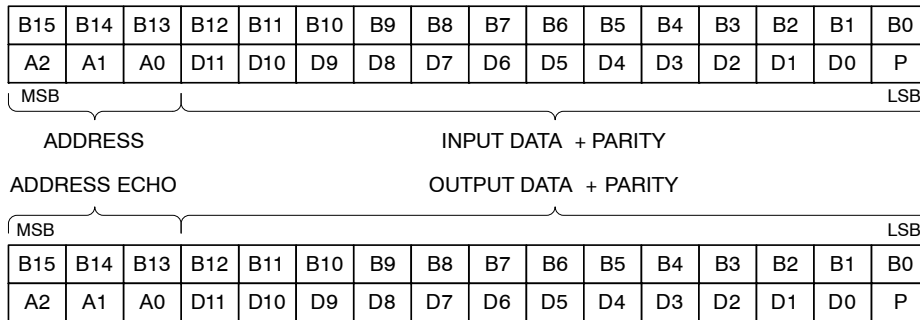

Figure 12. SPI Data Format

NCV7520

Table 1. VALID REGISTER ADDRESSES

Function	Type	Alias	A2	A1	A0
GATE & MODE SELECT	W	R0	0	0	0
DIAGNOSTIC PULSE	W	R1	0	0	1
DIAGNOSTIC CONFIG 1	W	R2	0	1	0
DIAGNOSTIC CONFIG 2	W	R3	0	1	1
STATUS CH2:0	R	R4	1	0	0
STATUS CH5:3	R	R5	1	0	1
REVISION INFO	R	R6	1	1	0
RESERVED	TEST	R7	1	1	1

The 16-bit data sent by the NCV7520 is an echo of the previously received 3-bit address with the remainder of the 12-bit data and parity bit formatted into one of four response types - an echo of the previously received input data, the

diagnostic status information, the device revision information, or a transmission error (Table 2). The first response frame sent after reset (via POR or RSTB) is the device revision information.

Table 2. OUTPUT RESPONSE TYPES

ECHO RESPONSE															
A2	A1	A0	D11	D10	D9	D8	D7	D6	D5	D4	D3	D2	D1	D0	P
ADDRESS ECHO			INPUT DATA ECHO												?
DIAGNOSTIC STATUS RESPONSE															
1	0	0	0	0	ENB	CH2	CH1	CH0	CH2	CH1	CH0	CH2	CH1	CH0	?
1	0	1	0	0	ENB	CH5	CH4	CH3	CH5	CH4	CH3	CH5	CH4	CH3	?
						ST2			ST1			ST0			
DEVICE REVISION RESPONSE															
1	1	0	0	0	0	0	1	0	D5	D4	D3	D2	D1	D0	?
									DIE REVISION			MASK REVISION			
TRANSMISSION ERROR RESPONSE															
1	1	1	0	1	0	1	0	1	0	1	0	1	0	D0	P
PARITY ERROR														1	0
1	1	1	0	1	0	1	0	1	0	1	0	1	0	D0	P
FRAME ERROR														0	1

Table 3. INPUT COMMAND STRUCTURE OVERVIEW

ALIAS	3-BIT ADDR			12-BIT COMMAND INPUT DATA												ODD PARITY
R0	A2	A1	A0	D11	D10	D9	D8	D7	D6	D5	D4	D3	D2	D1	D0	P
	0	0	0	M5	M4	M3	M2	M1	M0	G5	G4	G3	G2	G1	G0	?
GATE & MODE SELECT			1 = AUTO RETRY DEFAULT = LATCH OFF						1 = GATx ON DEFAULT = ALL OFF							
R1	A2	A1	A0	D11	D10	D9	D8	D7	D6	D5	D4	D3	D2	D1	D0	P
	0	0	1	F5	F4	F3	F2	F1	F0	N5	N4	N3	N2	N1	N0	?
DIAGNOSTIC PULSE			1 = DIAGNOSTIC OFF PULSE DEFAULT = 0						1 = DIAGNOSTIC ON PULSE DEFAULT = 0							
R2	A2	A1	A0	D11	D10	D9	D8	D7	D6	D5	D4	D3	D2	D1	D0	P
	0	1	0	C11	C10	C9	C8	C7	C6	C5	C4	C3	C2	C1	C0	?
DIAGNOSTIC CONFIG 1			%VFLTREF SELECT			TBLANK OFF		TBLANK ON		TIMER RANGE		CHANNEL SELECT				
R3	A2	A1	A0	D11	D10	D9	D8	D7	D6	D5	D4	D3	D2	D1	D0	P
	0	1	1	X	X	X	X	X	X	CH5	CH4	CH3	CH2	CH1	CH0	?
DIAGNOSTIC CONFIG 2			1 = ENABLE DIAGNOSTIC DEFAULT = ENABLE						OPEN LOAD DIAGNOSTIC ENABLE/DISABLE							
R4	A2	A1	A0	D11	D10	D9	D8	D7	D6	D5	D4	D3	D2	D1	D0	P
	1	0	0	X	X	X	X	X	X	X	X	X	X	X	X	?
DIAGNOSTIC STATUS CH2:CH0			RETURN ENB STATUS; D[9] = 0 = ENABLED RETURN CH2:CH0 STATUS; DEFAULT D[8:0] = 1													
R5	A2	A1	A0	D11	D10	D9	D8	D7	D6	D5	D4	D3	D2	D1	D0	P
	1	0	1	X	X	X	X	X	X	X	X	X	X	X	X	?
DIAGNOSTIC STATUS CH5:CH3			RETURN ENB STATUS; D[9] = 0 = ENABLED RETURN CH5:CH3 STATUS; DEFAULT D[8:0] = 1													
R6	A2	A1	A0	D11	D10	D9	D8	D7	D6	D5	D4	D3	D2	D1	D0	P
	1	1	0	X	X	X	X	X	X	X	X	X	X	X	X	?
REVISION INFORMATION			RETURN REVISION INFORMATION													
R7	A2	A1	A0	D11	D10	D9	D8	D7	D6	D5	D4	D3	D2	D1	D0	P
	1	1	1	T11	T10	T9	T8	T7	T6	T5	T4	T3	T2	T1	T0	?
RESERVED			RESERVED FOR TEST MODE													

Gate & Mode Select – Register R0

Each GAT_X output is turned on/off serially by programming its respective G_X bit (Table 4). When parallel inputs $IN_X = 0$, setting $R0.G_X = 1$ causes the selected GAT_X output to drive its external MOSFET's gate to V_{CC2} (ON). Setting $R0.G_X = 0$ causes the selected GAT_X output to drive its external MOSFET's gate to V_{SS} (OFF.) Note that the actual state of the output depends on POR, RSTB, ENB and shorted load fault states ($SHRT_X$) as later defined by Equation 1. Default after reset is $R0.D[11:0] = 0$ (all channels latch-off mode, all outputs OFF.) R0 is an echo type response register.

The disable mode for shorted load (on-state) faults is controlled by each channel's respective M_X bit. Setting $R0.M_X = 0$ causes the selected GAT_X output to latch-off when a fault is detected.

When latch-off mode is selected, recovery is performed for all channels by disabling then re-enabling the device via the ENB input. Recovery for selected channels is performed via the un-latch sequence by reading the status registers (R4, R5) for the faulted channels then requesting a diagnostic ON or OFF pulse for the desired channels.

When auto-retry mode is selected, the corresponding GAT_X output is turned off upon detection of a fault for the

duration of the channel’s fault retry (or refresh) time (t_{FR}). Once active, the refresh timer will run to completion and the output will follow the input at the end of the retry interval.

The timer is reset when $ENB = 1$ or when the mode is changed to latch-off (provided no SCB or GLO fault is present in the channel’s status).

Table 4. GATE & MODE SELECT REGISTER

R0	A2	A1	A0	D11	D10	D9	D8	D7	D6	D5	D4	D3	D2	D1	D0	P
	0	0	0	0	M5	M4	M3	M2	M1	M0	G5	G4	G3	G2	G1	G0
				1 = AUTO RETRY DEFAULT = LATCH OFF						1 = GATx ON DEFAULT = ALL OFF						

Diagnostic Pulse Select – Register R1

The NCV7520 has functionality to perform either on-state or off-state diagnostic pulses (Table 5) The function is provided for applications having loads normally in a continuous on or off state. The diagnostic pulse function is available for both latch-off and auto-retry modes. The pulse executes for the selected channel(s) on low-high transition on CSB. Default after reset is $R1.D[11:0] = 0$. R1 is an echo type response register.

Diagnostic pulses have priority and are not dependant on the input (IN_x, G_x) or the output (GAT_x) states. The pulse does not execute if: $ENB = 1$ (device is disabled); both an ON and OFF pulse is simultaneously requested for the same channel; an ON or OFF pulse is requested and a SCB (shorted load) diagnostic code is present for the selected channels; an ON or OFF pulse is requested while a pulse is currently executing in the selected channels (i.e. a blanking

timer is active); the selected channels are currently under auto-retry control (i.e. refresh timer is active).

When $R1.F_x = 1$, the diagnostic OFF pulse command is executed. The open load diagnostic is turned on if disabled (see Diagnostic Config 2 – R3), the output changes state for the programmed $t_{BL(OFF)}$ blanking period, and the diagnostic status is latched if of higher priority than the previous status. The output assumes the currently commanded state at the end of the pulse.

When $R1.N_x = 1$, the diagnostic ON pulse command is executed. The output changes state for the programmed $t_{BL(ON)}$ blanking period, and the diagnostic status is latched if of higher priority than the previous status. The output assumes the currently commanded state at the end of the pulse. A flowchart for the diagnostic pulse is given in Figure 16.

Table 5. DIAGNOSTIC PULSE SELECT REGISTER

R1	A2	A1	A0	D11	D10	D9	D8	D7	D6	D5	D4	D3	D2	D1	D0	P
	0	0	1	1	F5	F4	F3	F2	F1	F0	N5	N4	N3	N2	N1	N0
				1 = DIAGNOSTIC OFF PULSE DEFAULT = 0						1 = DIAGNOSTIC ON PULSE DEFAULT = 0						

Diagnostic Config 1 – Register R2

The diagnostic Config 1 register programs the turn-on/off blanking time and shorted load fault detection references for each channel (Table 6) Bits $R2.C[2:0]$ select which channels receive the configuration data (Table 7). Bit $R2.C[4]$ selects the turn-on blanking time range (PV = passenger vehicle, CV = commercial vehicle) and bits $R2.C[8:5]$ select

turn-on/off blanking time (Table 8). Bits $R2.C[11:9]$ select the fault reference (Table 9). Default after reset is indicated by “(DEF)” in the tables. R2 is an echo type response register.

If a blanking timer is currently running when the register is changed, the new value is accepted but will not take effect until the next activation of the timer.

Table 6. DIAGNOSTIC CONFIG 1 REGISTER

R2	A2	A1	A0	D11	D10	D9	D8	D7	D6	D5	D4	D3	D2	D1	D0	P
	0	1	0	0	C11	C10	C9	C8	C7	C6	C5	C4	C3	C2	C1	C0
				%VFLTREF SELECT			TBLANK OFF		TBLANK ON		TIMER RANGE		CHANNEL SELECT			

Table 7. CHANNEL SELECT

C2	C1	C0	CHANNEL SELECT
0	0	0	NONE
0	0	1	CHANNEL 0
0	1	0	CHANNEL 1
0	1	1	CHANNEL 2
1	0	0	CHANNEL 3
1	0	1	CHANNEL 4
1	1	0	CHANNEL 5
1	1	1	ALL (DEF)

Table 8. BLANKING TIME SELECT

C8	C7	C6	C5	C4	C3	TIMER RANGE	TBLANK OFF	TBLANK ON
X	X	0	0	0	X	PV (DEF)	–	6.0 μs
X	X	0	1	0	X		–	12.0 μs
X	X	1	0	0	X		–	26.0 μs (DEF)
X	X	1	1	0	X		–	52.0 μs
X	X	0	0	1	X	CV	–	16.9 μs
X	X	0	1	1	X		–	32.5 μs
X	X	1	0	1	X		–	77.9 μs
X	X	1	1	1	X		–	127.3 μs
0	0	X	X	X	X	–	55.0 μs	–
0	1	X	X	X	X	–	80.0 μs	–
1	0	X	X	X	X	–	160.0 μs (DEF)	–
1	1	X	X	X	X	–	320.0 μs	–

Table 9. FAULT REFERENCE SELECT

C11	C10	C9	%VFLTREF SELECT
0	0	0	25 (DEF)
0	0	1	40
0	1	0	50
0	1	1	60
1	0	0	70
1	0	1	80
1	1	0	90
1	1	1	100

Diagnostic Config 2 – Register R3

Off-state open load diagnostic currents for each channel can be enabled or disabled for LED loads. Short to GND diagnostic is unaffected. Channels are selected by bit positions in the register (Table 10.) Open load status (OLF)

information is suppressed when the diagnostic is turned off via R3. Open load diagnostic and OLF status is temporarily enabled when a diagnostic off pulse is executed via R1. Default after reset is R3.D[5:0] = 1. R3 is an echo type response register.

Table 10. DIAGNOSTIC CONFIG 2 REGISTER

R3	A2	A1	A0	D11	D10	D9	D8	D7	D6	D5	D4	D3	D2	D1	D0	P
	0	1	1	X	X	X	X	X	X	CH5	CH4	CH3	CH2	CH1	CH0	?
										1 = ENABLE DIAGNOSTIC DEFAULT = ENABLE						
OPEN LOAD DIAGNOSTIC ENABLE/DISABLE																

Diagnostic Status Registers – Register R4 & R5

Diagnostic status and ENB status information is returned when R4 or R5 is selected (Table 11) Diagnostic status information for each channel is 3-bit (ST2:0) priority encoded (Table 12). Bit D[9] returns the state of the ENB input e.g. D[9] = 0 when ENB = 0 (enabled). Status is latched for the currently higher priority fault and is not demoted if a fault of lower priority occurs. The latched status is not affected by ENB. Default response after reset is D[8:0] = 1 (“Diagnostic Not Complete”).

When a channel is configured for auto-retry mode, its status register bits are reset to “Diagnostic Not Complete” after reading the register (see Figure 18).

When a channel is configured for latch-off mode and no “SCB” status is present, its register bits are reset to “Diagnostic Not Complete” after reading the register. If “SCB” status is present, its register bits are set to “GLO” after reading the register. This status is maintained until the channel is un-latched either by successfully executing the un-latch sequence or by disabling then re-enabling the device via the ENB input (Figure 18). The “GLO” status allows the application to detect a latched-off channel in the event the “SCB” status data is discarded by the controller due to SPI transmission error.

Table 11. DIAGNOSTIC STATUS REGISTERS

	A2	A1	A0	D11	D10	D9	D8	D7	D6	D5	D4	D3	D2	D1	D0	P	
R4	1	0	0	X	X	X	X	X	X	X	X	X	X	X	X	?	SI
	1	0	0	0	0	ENB	CH2	CH1	CH0	CH2	CH1	CH0	CH2	CH1	CH0	?	SO
R5	1	0	1	X	X	X	X	X	X	X	X	X	X	X	X	?	SI
	1	0	1	0	0	ENB	CH5	CH4	CH3	CH5	CH4	CH3	CH5	CH4	CH3	?	SO
							ST2			ST1			ST0				

Table 12. DIAGNOSTIC STATUS ENCODING

ST2	ST1	ST0	STATUS	PRIORITY
0	0	0	GLO – GATx LATCHED OFF	0 HIGHEST
0	0	1	SCB – SHORT TO BATTERY	1
0	1	0	SCG – SHORT TO GROUND	2
0	1	1	OLF – OPEN LOAD	3 (Note)
1	0	0	Diagnostic Complete – No Fault	4
1	0	1	No SCB Fault – ON State	5
1	1	0	No SCG/OLF Fault – OFF State	6
1	1	1	Diagnostic Not Complete (DEFAULT)	7 LOWEST

NOTE: OLF status report is suppressed when open load diagnostic is turned off via Diagnostic Config 2 – register R3

Revision Information – Register R6

Device revision information is returned when R6 is selected (Table 13). Output bits D[11:8] are hard coded to 0, bits D[7:6] are encoded with the specific device identifier (i.e. “00” = 7518, “01” = 7519, “10” = 7520), bits D[5:3] are hard coded with the die (silicon) revision, and bits D[2:0] are hard coded with the mask (interconnect) revision. The first

response frame sent after reset is the device revision information. The revision encoding scheme is shown in Table 14.

Mask revision may be incremented when an interconnect revision is made. Die revision is incremented when a silicon revision is made. Mask revision is reset to “000” when a die revision is made.

Table 13. DEVICE REVISION INFORMATION

R6	A2	A1	A0	D11	D10	D9	D8	D7	D6	D5	D4	D3	D2	D1	D0	P	
	1	1	0	X	X	X	X	X	X	X	X	X	X	X	X	?	SI
	1	1	0	0	0	0	0	1	0	D5	D4	D3	D2	D1	D0	?	SO
								DEVICE		DIE REV			MASK REV				

Table 14. DEVICE REVISION ENCODING

D5	D4	D3		D2	D1	D0	
DIE			REV	MASK			REV
0	0	0	A	0	0	0	0
0	0	1	B	0	0	1	1
0	1	0	C	0	1	0	2
0	1	1	D	0	1	1	3
1	0	0	E	1	0	0	4
1	0	1	F	1	0	1	5
1	1	0	G	1	1	0	6
1	1	1	H	1	1	1	7

Reserved – Register R7

Register R7 is reserved for factory test use. Data sent to R7 is ignored. In normal operation, R7 is an echo type response

register. In the event of a transmission error, R7 responds with either a parity or frame error on the next valid frame.

Table 15. TEST MODE REGISTER

R7	A2	A1	A0	D11	D10	D9	D8	D7	D6	D5	D4	D3	D2	D1	D0	P			
	1	1	1	X	X	X	X	X	X	X	X	X	X	X	X	?	SI		
	ECHO			INPUT DATA ECHO													?	SO	
	PARITY ERR			0	1	0	1	0	1	0	1	0	1	0	1	0	1	0	SO
	FRAME ERR			0	1	0	1	0	1	0	1	0	1	0	0	1	0	SO	

Gate Driver Control and Enable

Each GAT_X output may be turned on by either its respective parallel IN_X input or the Gate & Mode Select register bits R0.G[5:0] via SPI communication. The device’s RSTB reset and ENB enable inputs can be used to implement global control functions, such as system reset, over-voltage or input override by a watchdog controller.

The RSTB input has an internal pull-down resistor and the ENB input has an internal pull-up resistor. Each parallel input has an internal pull-down resistor. Parallel input is recommended when low frequency (≤ 10 kHz) PWM operation of the outputs is desired. Unused parallel inputs should be connected to GND.

When RSTB is brought low, all GAT_X outputs, the timer clock, the SPI, and the FLT_B flag are disabled. All internal registers are initialized to their default states, status data is

cleared, and the SPI and FLT_B are enabled when RSTB goes high.

ENB disables all GAT_X outputs and diagnostics, and resets the auto-retry timer when brought high. The SPI is enabled, registers remain as programmed, and status data is not cleared. Latched-off outputs are re-enabled and their status can be updated when ENB goes low.

The IN_X input state and the G_X register bit data are logically combined with the internal (active low) power-on reset signal (POR), the RSTB and ENB input states, and the shorted load state (internal SHRT_X) to control the corresponding GAT_X output such that:

$$GAT_X = POR \cdot RSTB \cdot ENB \cdot SHRT_X \cdot (IN_x + G_x) \tag{eq. 1}$$

The GAT_X state truth table is given in Table 16.

Table 16. GATE DRIVER TRUTH TABLE

POR	RSTB	ENB	SHRT _x	IN _x	G _x	GAT _x
0	X	X	X	X	X	L
1	0	X	X	X	X	L
1	1	1	X	X	X	L
1	1	0	1	0	0	L
1	1	0	1	1	X	H
1	1	0	1	X	1	H
1	1	0	0	X	X	→L
1	1	0→1	X	X	G _x	→L
1	1	1→0	→1	0	G _x	→G _x
1	1→0	X	X	X	→0	→L

Gate Drivers

The non-inverting GAT_x drivers are symmetrical resistive switches (350 Ω typ.) to the VCC2 and VSS voltages. While the outputs are designed to provide symmetrical gate drive to an external MOSFET, load current

switching symmetry is dependent on the characteristics of the external MOSFET and its load. Figure 13 shows the gate driver block diagram.

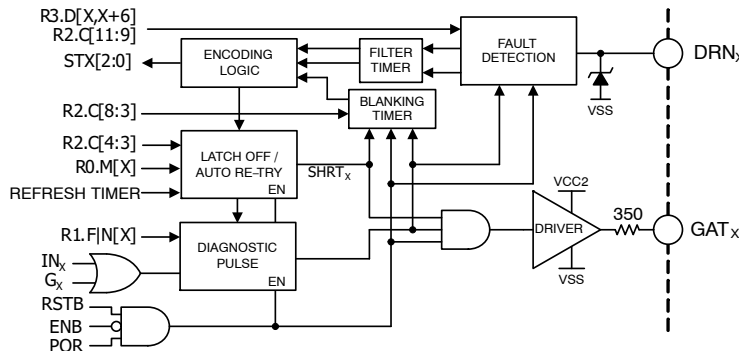

Figure 13. Gate Driver Channel

Blanking and Filter Timers

Blanking timers are used to allow drain feedback to stabilize after a channel is commanded to change states. Filter timers are used to suppress glitches while a channel is in a stable state.

A turn-on blanking timer is started when a channel is commanded on. Drain feedback is sampled after t_{BL(ON)}. A turn-off blanking timer is started when a channel is commanded off. Drain feedback is sampled after t_{BL(OFF)}.

A filter timer is started when a channel is in a stable state and a fault detection threshold associated with that state has been crossed. Drain feedback is sampled after t_{FF(ON|OFF)}. A filter timer may also be started while a blanking timer is active, so the blanking interval could be extended by the filter time.

Each channel has independent blanking and filter timers. The parameters for the t_{FF(ON|OFF)} filter timer are the same for all channels. The turn-on/off blanking time for each channel can be selected via the Diagnostic Config 1 register bits R2.C[8:3] (Tables 6 and 8).

If a blanking timer is currently running when the register is changed, the new value is accepted but will not take effect until the next activation of the timer.

Blanking timers for all channels are started when both RSTB goes high and ENB goes low, when RSTB goes high while ENB is low, when ENB goes low while RSTB is high, or by POR.

Fault Diagnostics and Behavior

Each channel has independent fault diagnostics and employs blanking and filter timers to suppress false faults. An external MOSFET is monitored for fault conditions by connecting its drain to a channel’s DRN_x feedback input through an optional external series resistor.

Shorted load (or short to V_{LOAD}) faults can be detected when a driver is on. Open load or short to GND faults can be detected when a driver is off.

On-state faults will initiate MOSFET protection behavior, set the FLTB flag and the respective channel’s status bits in

the device's status registers. Off-state faults will simply set the FLTB flag and the channel's status bits.

Status information is retrieved by SPI read of registers R4 and R5 (Table 11). Status information for each channel is 3-bit priority encoded (Table 12). Shorted load fault has priority over open load and short to GND. Short to GND has priority over open load. Priority ensures that the most severe fault data is available at the next SPI read.

Status is latched for the currently higher priority fault and is not demoted if a fault of lower priority occurs. The status registers are reset to "Diagnostic Not Complete" after reading the registers, or by asserting a reset via RSTB. Status registers are not affected by ENB.

When either RSTB is low or ENB is high, diagnostics are disabled. When RSTB is high and ENB is low, open load diagnostics are enabled according to the state of the Diagnostic Config 2 register bits R3.D[5:0] (Table 10).

Diagnostic Pulse Mode

The NCV7520 has functionality to perform either on-state or off-state diagnostic pulses (Table 5). The function is provided for applications having loads normally in a continuous on or off state. The diagnostic pulse function is available for both latch-off and auto-retry modes. The pulse executes for the selected channel(s) on low-high transition on CSB.

Diagnostic pulses have priority and are not dependant on the input (IN_X, G_X) or the output (GAT_X) states. The pulse does not execute if: ENB = 1 (device is disabled); both an ON and OFF pulse is simultaneously requested for the same channel; an ON or OFF pulse is requested and a SCB (shorted load) diagnostic code is present for the selected channels; an ON or OFF pulse is requested while a pulse is currently executing in the selected channels (i.e. a blanking timer is active); the selected channels are currently under auto-retry control (i.e. refresh timer is active).

When R1.F_X = 1, the diagnostic OFF pulse command is executed. The open load diagnostic is turned on if disabled (see Diagnostic Config 2 – R3), the output changes state for the programmed t_{BL(OFF)} blanking period, and the diagnostic status is latched if of higher priority than the previous status. The output assumes the currently commanded state at the end of the pulse.

When R1.N_X = 1, the diagnostic ON pulse command is executed. The output changes state for the programmed t_{BL(ON)} blanking period, and the diagnostic status is latched if of higher priority than the previous status. The output assumes the currently commanded state at the end of the pulse. A flowchart for the diagnostic pulse is given in Figure 17.

Shorted Load Detection

An external reference voltage applied to the FLTREF input serves as a common reference for all channels (Figures 1 and 2). The FLTREF voltage should be within the range of 0.35 to 2.75 V and can be derived via a voltage divider between V_{CC1} and GND.

Shorted load detection thresholds can be programmed via SPI in eight increments that are ratiometric to the applied FLTREF voltage. Separate thresholds can be selected for each channel via the Diagnostic Config 1 register bits R2.C[11:9] (Tables 6 and 9).

A shorted load fault is detected when a channel's DRN_X feedback is greater than its selected fault reference after either the turn-on blanking or the filter has timed out.

Shorted Load Fault Disable and Recovery

Shorted load fault disable mode for each channel is individually SPI programmable via the device's Gate & Mode select register bits R0.M[5:0] (Table 4).

When latch-off mode (default) is selected, the corresponding GAT_X output is latched off upon detection of a fault. Recovery from latch-off is performed for all channels by disabling then re-enabling the device via the ENB input. Recovery for selected channels is performed via the un-latch sequence by reading the status registers (R4, R5) for the faulted channels then requesting a diagnostic ON or OFF pulse for the desired channels.

When auto-retry mode is selected, the corresponding GAT_X output is turned off upon detection of a fault for the duration of the channel's fault retry (or refresh) time (t_{FR}). Once active, the refresh timer will run to completion and the output will follow the input at the end of the retry interval. The timer is reset when ENB = 1 or when the mode is changed to latch-off (provided no SCB or GLO fault is present in the channel's status).

The output is automatically turned back on (if still commanded on) when the retry time ends. The channel's DRN_X feedback is re-sampled after the turn-on blanking time. The output will automatically be turned off if a fault is again detected. This behavior will continue for as long as the channel is commanded on and the fault persists.

In either mode, a fault may exist at turn-on or may occur some time afterward. To be detected, the fault must exist longer than either t_{BL(ON)} at turn-on or longer than t_{FF(ON)} some time after turn-on. The length of time that a MOSFET stays on during a shorted load fault is thus limited to either t_{BL(ON)} or t_{FF(ON)}.

Fault Disable Mode Changes

A channel's fault disable mode may be changed between latch-off and auto-retry at any time provided that neither an SCB nor a GLO fault code is present for that channel (see Table 12).

When the current mode is auto-retry, the mode may be changed to latch-off but this change will be held pending while an SCB fault code is still present. Once the status is read and the SCB fault code is cleared then the mode change to latch-off will be executed.

When the current mode is latch-off, the mode may be changed to auto-retry but this change will also be held pending while an SCB or GLO fault code is still present. Once the status is read and the SCB fault code is cleared, an un-latch sequence is required to clear the GLO code then the mode change to auto-retry will be executed.

Open Load and Short to GND Detection

A window comparator with references and bias currents proportional to V_{LOAD} is used to detect open load or short to GND faults when a channel is off. Each channel's DRN_x feedback is compared to the references after either the turn-off blanking or the filter has timed out. Figure 14 shows the DRN_x bias and fault detection zones.

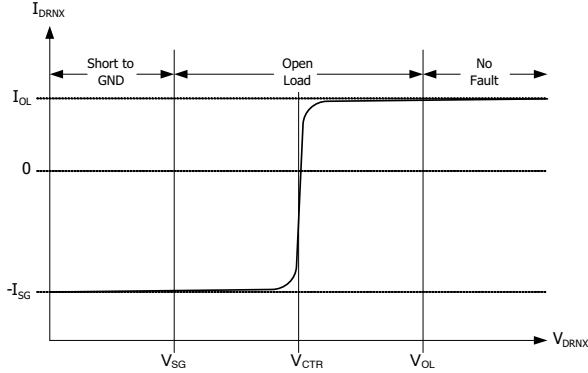

Figure 14. DRN_x Bias and Fault Detection Zones

No fault is detected if the feedback voltage at DRN_x is greater than the V_{OL} open load reference. If the feedback is less than the V_{SG} short to GND reference, a short to GND fault is detected. If the feedback is less than V_{OL} and greater than V_{SG} , an open load fault is detected.

When either $RSTB$ is low or ENB is high, diagnostics are disabled. When $RSTB$ is high and ENB is low, off-state diagnostics are enabled according to the content of the Diagnostic Config 2 register bits $R3.D[5:0]$ (Tables 10 and 17.)

Table 17. OPEN LOAD DIAGNOSTIC CONTROL (CH0 shown)

D0	OPEN LOAD DIAGNOSTIC	
0	OFF	
1	ON	(DEF)

Figure 15 shows the simplified detection circuitry. Bias currents I_{SG} and I_{OL} are applied to a bridge along with bias voltage V_{CTR} .

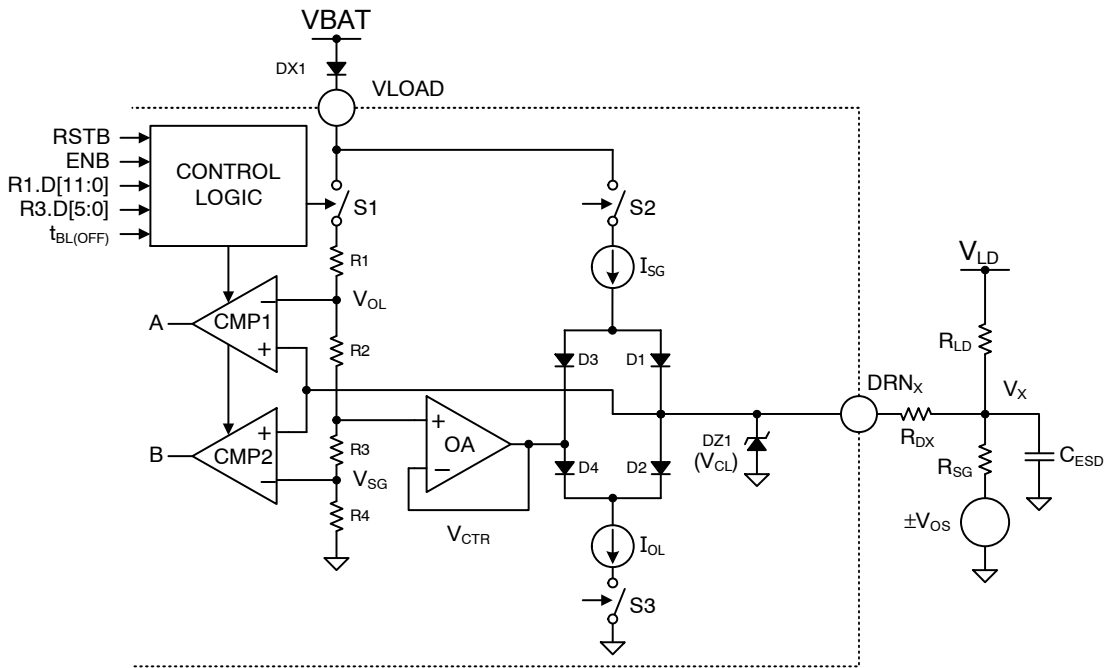

Figure 15. Short to GND/Open-Load Detection

Current I_{SG} will charge external capacitance C_{ESD} toward V_{CTR} . V_{DRNX} will remain at V_{CTR} if an open load truly exists, otherwise the capacitance can continue to charge via R_{LD} .

When a channel is off and V_{LD} and R_{LD} are present, R_{SG} is absent, and $V_{DRNX} \gg V_{CTR}$, bias current I_{OL} is supplied from V_{LD} to ground through resistors R_{LD} and optional R_{DX} , and bridge diode $D2$. Bias current I_{SG} is supplied from V_{LOAD} to V_{CTR} through $D3$. No fault is detected if the feedback voltage (V_{LD} minus the total voltage drop caused by I_{OL} and the resistance in the path) is greater than V_{OL} .

When R_{SG} and either V_{LD} or R_{LD} are absent, the bridge will self-bias so that V_{DRNX} will settle to about V_{CTR} . An open load fault can be detected since the feedback is between V_{SG} and V_{OL} .

Short to GND detection can tolerate up to a ± 1.0 V offset (V_{OS}) between the NCV7520's GND and the short. When R_{SG} is present and $V_{DRNX} \ll V_{CTR}$, bias current I_{SG} is supplied from V_{LOAD} to V_{OS} through $D1$, and the R_{SG} and optional R_{DX} resistances. Bias current I_{OL} is supplied from V_{CTR} to ground through $D4$.

When V_{LD} and R_{LD} are present, a voltage divider between V_{LD} and V_{OS} is formed by R_{LD} and R_{SG} . A "soft" short to GND may be detected in this case depending on the ratio of R_{LD} and R_{SG} and the values of R_{DX} , V_{LD} , and V_{OS} .

Optional R_{DX} resistor is used when voltages greater than the 60 V minimum clamp voltage or down to -1 V are expected at the DRNX inputs. Note that the comparators see a voltage drop or rise due to the R_{DX} resistance and the bias currents. This produces an error in the comparison of feedback voltage at the comparator inputs to the actual node voltage V_X .

Several equations for choosing R_{DX} and for predicting open load or short to GND resistances, and a discussion of the dynamic behavior of the short to GND/ open load diagnostic are provided in the "Application Guidelines" section of this data sheet.

Fault Flag (FLTb)

The open-drain active-low fault flag output can be used to provide immediate fault notification to a host controller. Fault detection from all channels is logically ORed to the flag (Figure 16) The FLTb outputs from several devices can be wire-ORed to a common pull-up resistor connected to the controller's 3.3 or 5 V V_{DD} supply.

When RSTB and CSB are high, and ENB is low, the flag is set (low) when any channel detects any fault. The flag is reset (hi-Z) and disabled during POR, when either RSTB or CSB is low, or when ENB is high. See Table 18 for details.

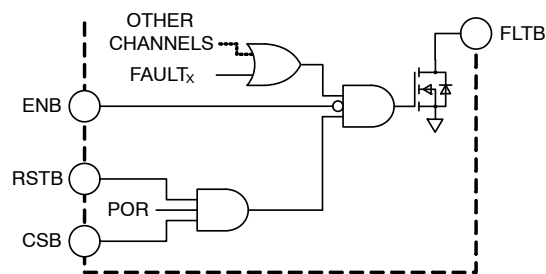

Figure 16. FLTb Flag Logic

The interaction between CSB and FLTb facilitates fault polling. When multiple NCV7520 devices are configured for parallel SPI access with individual CSB addressing, the device reporting a fault can be identified by pulsing each CSB in turn.

Fault Detection and Capture

Each channel of the NCV7520 is capable of detecting shorted load faults when the channel is on, and short to ground or open load faults when the channel is off. Each fault type is priority encoded into 3-bit per channel fault data (Table 12.) Shorted load fault data has priority over open load and short to GND data. Short to GND data has priority over open load data. Priority ensures that the most severe fault data is available at the next SPI read.

A drain feedback input for each channel compares the voltage at the drain of the channel's external MOSFET to several internal reference voltages. Separate detection references are used to distinguish the three fault types. Blanking and filter timers are used respectively to allow for output state transition settling and for glitch suppression.

When enabled and configured, each channel's drain feedback input is continuously compared to references appropriate to the channel's input state to detect faults, but the comparison result is only latched at the end of either a blanking or filter timer event.

Blanking timers for all channels are started when both RSTB goes high and ENB goes low, when RSTB goes high while ENB is low, when ENB goes low while RSTB is high, or by POR. A single channel's blanking timer is triggered when its input state changes. If the comparison of the feedback to a reference indicates an abnormal condition when the blanking time ends, a fault has been detected and the fault data is latched into the channel's status register.

A channel's filter timer is triggered when its drain feedback comparison state changes. If the change indicates an abnormal condition when the filter time ends, a fault has

been detected and the fault data is latched into the channel's status register.

Thus, a state change of the inputs (POR, RSTB, ENB, IN_X or G_X) or a state change of an individual channel's feedback (DRN_X) comparison must occur for a timer to be triggered and a detected fault to be captured.

Fault Capture, SPI Communication, and SPI Frame Error Detection

The NCV7520 latches a fault when it is detected, and parity and frame error detection will not allow any register to accept data if an invalid frame occurred.

The fault capture, parity, and frame error detection strategies combine to ensure that intermittent faults can be captured and identified, and that the device cannot be inadvertently re-programmed by a communication error.

When a fault has been detected, status information is latched into a channel's status register if of higher priority than current status, and the FLTB flag is set. The register holds the status data and ignores subsequent lower priority status data for that channel.

Current status information is transferred from the selected status register into the SPI shift register at the start of the SPI frame following the read status request. This ensures that status updates continue during inter-frame latency between the status request and delivery. The FLTB flag is reset when CSB goes low.

The selected status register is cleared when CSB goes high at the end of the SPI frame only if a valid frame has occurred; otherwise the register retains status information until a valid read frame occurs. The FLTB flag will be set if a fault is still present.

Status registers and the FLTB flag can also be cleared by toggling RSTB H→L→H. A full I/O truth table is given in Table 18.

Status Priority Encoding

Shorted load (SCB) faults can be detected when a driver is ON. Open load (OLF) or short to GND (SCG) faults can be detected when a driver is OFF. Status memory is priority encoded in a 3-bit per driver format (Table 12).

Status memory will be encoded "Diagnostic Not Complete" during a blanking period unless a fault of higher priority has previously been encoded. Status memory will be encoded "Diagnostic Not Complete" (cleared) for the selected status register at the end of a valid SPI frame.

"Diagnostic Complete – No Fault" will be encoded when BOTH on-state AND off-state diagnostics have been completed unless a fault of higher priority has previously been encoded. A diagnostic cycle may start from either an off-state or an on-state.

When a diagnostic cycle starts from an off-state and no fault is detected, "No SCG/OLF Fault" will be encoded unless a fault of higher priority has previously been encoded. Otherwise, "OLF" or "SCG" will be encoded unless a fault of higher priority has previously been encoded. If the cycle continues to an on-state and no fault is detected, "Diagnostic

Complete – No Fault" will be encoded. Otherwise, "SCB" will be encoded.

When a diagnostic cycle starts from an on-state and no fault is detected, "No SCB Fault" will be encoded unless a fault of higher priority has previously been encoded. Otherwise, "SCB" will be encoded. If the cycle continues to an off-state and no fault is detected, "Diagnostic Complete – No Fault" will be encoded unless a fault of higher priority has previously been encoded. Otherwise, "OLF" or "SCG" will be encoded unless a fault of higher priority has previously been encoded.

Status is latched for the currently higher priority fault and is not demoted if a fault of lower priority occurs. Default response after reset is D[8:0] = 1 ("Diagnostic Not Complete").

When a channel is configured for auto-retry mode, its status register bits are not affected by ENB and are reset to "Diagnostic Not Complete" after reading the register (see Figure 18).

When a channel is configured for latch-off mode and no "SCB" status is present, its register bits are reset to "Diagnostic Not Complete" after reading the register. If "SCB" status is present, its register bits are set to "GLO" after reading the register. This status is maintained until the channel is un-latched either by successfully executing the un-latch sequence or by disabling then re-enabling the device via the ENB input (Figure 18). The "GLO" status allows the application to detect a latched-off channel in the event the "SCB" status data is discarded by the controller due to SPI transmission error.

A Statechart diagram of the diagnostic status encoding is given in Figure 18 and additional clarification is given in "Appendix A – Diagnostic and Protection Behavior Tutorial".

VLOAD Undervoltage Detection

Undervoltage detection is used to suppress off-state diagnostics when VLOAD falls below the specified VL_{DUV} operating voltage. This ensures that potentially incorrect diagnostic status is not captured. On-state diagnostics continue to operate normally and status information is updated appropriately for an off-to-on input transition during undervoltage.

Previous status information and FLTB are unchanged when entering or leaving undervoltage. Upon a read of the status registers during undervoltage, the status is changed to "Diagnostic Not Complete" and will remain as such for channels in an off-state during the entire undervoltage interval. Status information and FLTB are updated appropriately if a channel changes from off to on during the interval.

When VLOAD returns to its normal operating range, a channel's t_{BL(OFF)} blanking timer is started if the channel was in an off state. Status information is updated appropriately after the t_{BL(OFF)} blanking interval, or after the t_{FF(OFF)} filter interval if the filter has been activated.

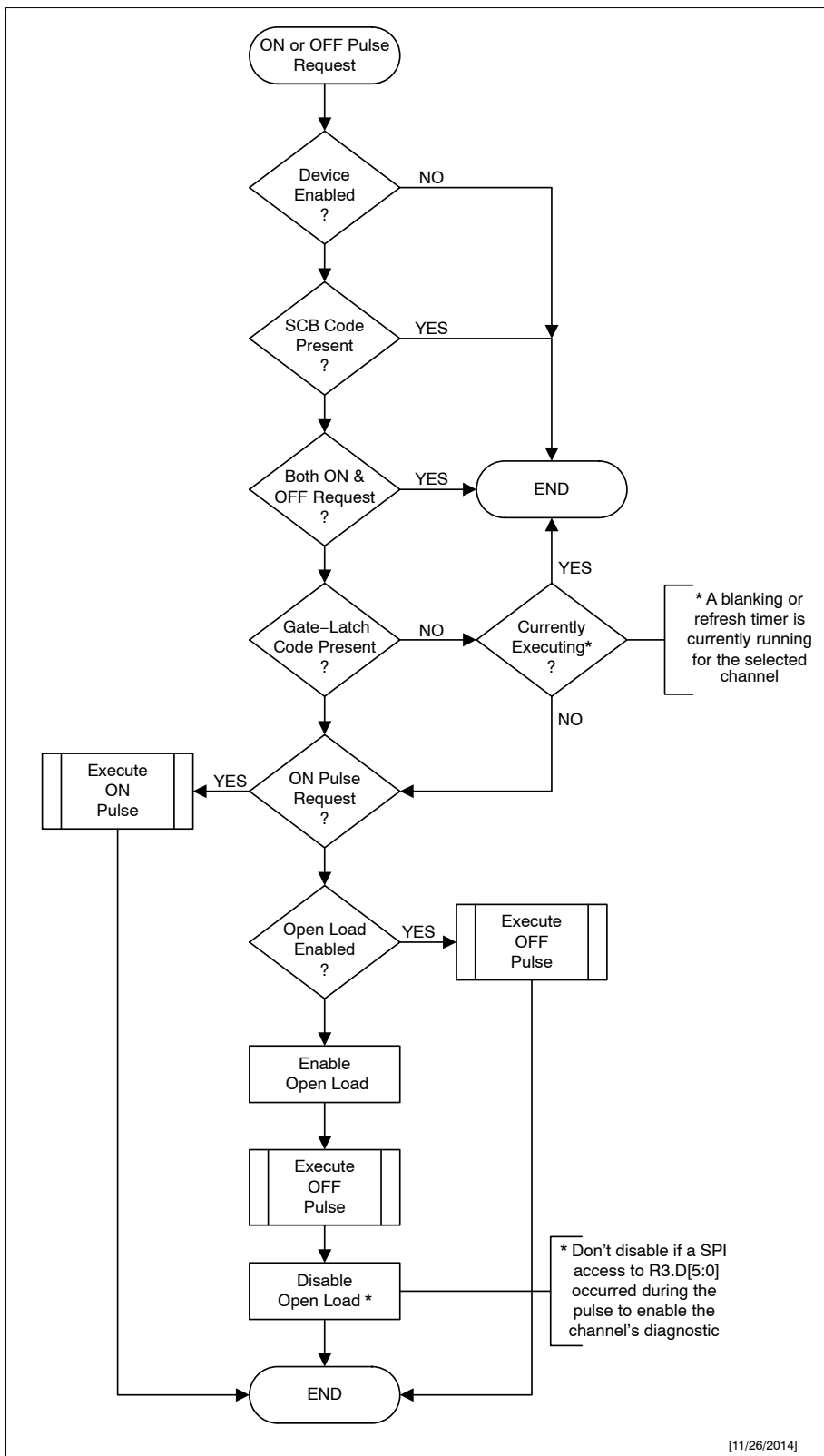

Figure 17. Pulse Mode Diagnostic Flowchart

NCV7520

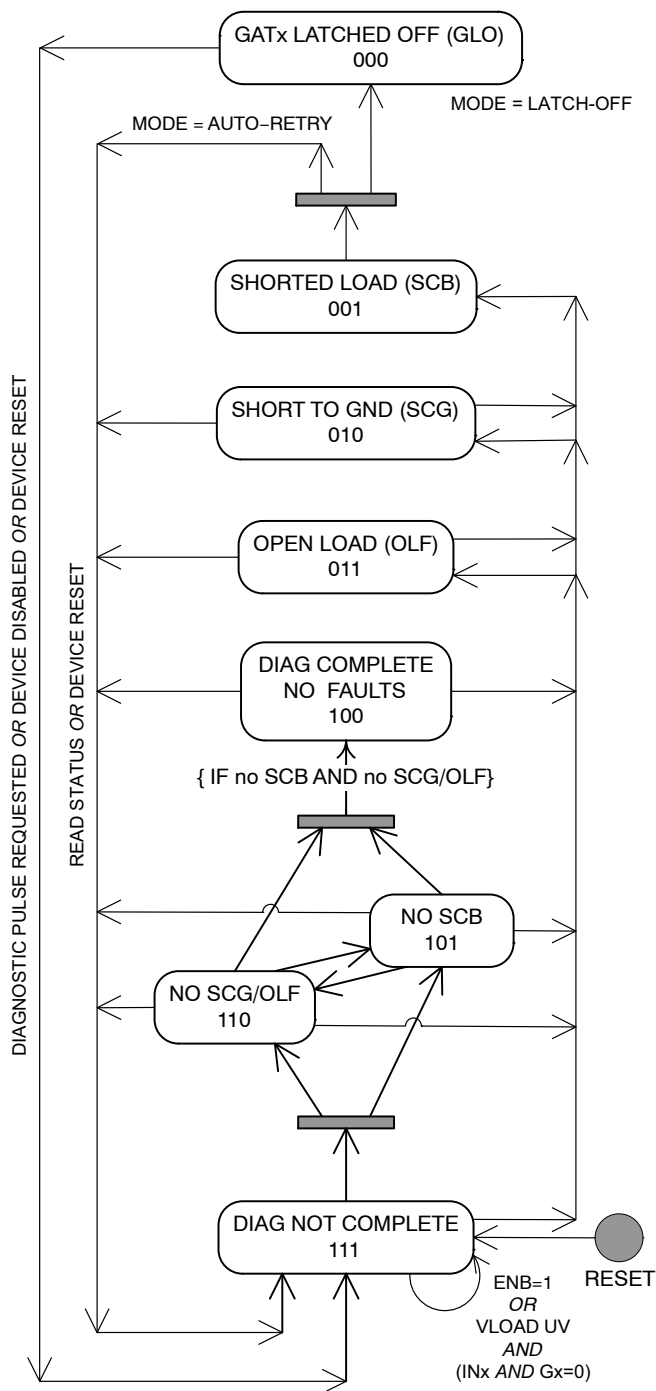

Figure 18. Diagnostic Status Encoding Statechart

Table 18. I/O TRUTH TABLE

Inputs							Outputs*			
POR	RSTB	ENB	CSB	IN _X	G _X	DRN _X	GAT _X	FLT _B	ST[2:0]	COMMENT
0	X	X	X	X	→0	X	→L	→Z	→111	POR RESET
1	0	X	X	X	X	X	L	Z	111	RSTB
1	1	1	X	X	G _X	X	L	Z	ST[2:0]	ENB
1	1→0	0	X	X	→0	X	→L	→Z	→111	RSTB RESET
1	1	0→1	X	X	G _X	X	→L	→Z	ST[2:0]	ENB DISABLE
1	1	0	X	0	0	> V _{OL}	L	Z	ST[2:0]	FLT _B RESET
1	1	0	1	0	0	V _{SG} < V < V _{OL}	L	L	→ 011	FLT _B SET - OLF
1	1	0	1→0	0	0	V _{SG} < V < V _{OL}	L	L→Z	011	FLT _B RESET
1	1	0	0→1	0	0	V _{SG} < V < V _{OL}	L	Z→L	011	FLT _B SET
1	1	0	1	0	0	< V _{SG}	L	L	→ 010	FLT _B SET - SCG
1	1	0	1→0	0	0	< V _{SG}	L	L→Z	010	FLT _B RESET
1	1	0	0→1	0	0	< V _{SG}	L	Z→L	010	FLT _B SET
1	1	0	X	1	X	< V _{FLTRREF}	H	Z	ST[2:0]	FLT _B RESET
1	1	0	1	1	X	> V _{FLTRREF}	L	L	→ 001	FLT _B SET - SCB
1	1	0	1→0	1	X	> V _{FLTRREF}	L	L→Z	001	FLT _B RESET
1	1	0	0→1	1	X	> V _{FLTRREF}	L	Z→L	001	FLT _B SET
1	1	0	1	X	1	< V _{FLTRREF}	H	Z	ST[2:0]	FLT _B RESET
1	1	0	1	X	1	> V _{FLTRREF}	L	L	→ 001	FLT _B SET - SCB
1	1	0	1→0	X	1	> V _{FLTRREF}	L	L→Z	001	FLT _B RESET
1	1	0	0→1	X	1	> V _{FLTRREF}	L	Z→L	001	FLT _B SET

* Output states after blanking and filter timers end and when channel is set to latch-off mode.

APPLICATION GUIDELINES

General

Unused DRN_X inputs should be connected to V_{LOAD} to prevent false open load faults. Unused parallel inputs should be connected to GND and unused reset or enable inputs should be connected to V_{CC1} or GND respectively. The user's software should be designed to ignore fault information for unused channels. For best shorted-load detection accuracy, the external MOSFET source terminals should be star-connected and the NCV7520's GND pin, and the lower resistor in the fault reference voltage divider should be Kelvin connected to the star (see Figure 2).

Consideration of auto-retry fault recovery behavior is necessary from a power dissipation viewpoint (for both the NCV7520 and the MOSFETs) and also from an EMI viewpoint.

Driver slew rate and turn-on/off symmetry can be adjusted externally to the NCV7520 in each channel's gate circuit by

the use of series resistors for slew control, or resistors and diodes for symmetry. Any benefit of EMI reduction by this method comes at the expense of increased switching losses in the MOSFETs.

The channel fault blanking timers must be considered when choosing external components (MOSFETs, slew control resistors, etc.) to avoid false faults. Component choices must ensure that gate circuit charge/discharge times stay within the turn-on/turn-off blanking times.

The NCV7520 does not have integral drain-gate flyback clamps. Self-clamped MOSFET products, such as onsemi's NIF9N05CL or NCV8440A devices, are recommended when driving unclamped inductive loads. This flexibility allows choice of MOSFET clamp voltages suitable to each application.

Appendix A – Diagnostic and Protection Behavior Tutorial

The following tutorial can be used together with Table 19 and the Statechart of Figure 18 to further understand how diagnostic status information is updated.

Initial Conditions:

- $VCC1 > V(POR)$ AND $RSTB = 1$
 - ◆ Digital core is disabled if these conditions are not valid
- VCC2 present and in specified range
- VLOAD present and in specified range

ON-State Diagnostic:

- SCB – Short Circuit to Battery
- Qualifiers:
 - ◆ VFLTREF present and in specified range
 - ◆ IN_x OR $G_x = 1$ AND $ENB = 1 \rightarrow 0$
 - ◆ $ENB = 0$ AND IN_x OR $G_x = 0 \rightarrow 1$
 - ◆ $ENB = 0$ AND ON-State Diagnostic Pulse Request
 - ◆ Blanking and/or Filter timer ran till end
 - √ “Diagnostic Complete”

OFF-State Diagnostic:

- OLF/SCG – Open Load Fault / Short Circuit to GND
- Qualifiers:
 - ◆ VLOAD present and in specified range
 - ◆ IN_x AND $G_x = 0$ AND $ENB = 1 \rightarrow 0$
 - ◆ $ENB = 0$ AND $IN_x = 1 \rightarrow 0$ AND $G_x = 0$
 - ◆ $ENB = 0$ AND $IN_x = 0$ AND $G_x = 1 \rightarrow 0$
 - ◆ $ENB = 0$ AND OFF-State Diagnostic Pulse Request
 - ◆ Blanking and/or Filter timer ran till end
 - √ “Diagnostic Complete”

Transition Trigger Events:

- Diagnostic status can transition from one state to another by several trigger events:
 - ◆ ON and/or OFF state diagnostic completed
 - ◆ SPI Read of the status register(s)
 - ◆ Recovery from VLOAD undervoltage detected
 - ◆ Reset via POR or RSTB

Table 19. DIAGNOSTIC STATE TRANSITIONS

Entering State	Description	Entering Criteria	Exiting Criteria	Exiting State
000	[GLO] – GATx Latched OFF	Mode = Latch-off <i>AND</i> SCB Detected <i>AND</i> READ	Request Diagnostic Pulse	111
001	[SCB] – Short Circuit to Battery	SCB Detected	READ	111
010	[SCG] – Short Circuit to Ground	SCG Detected	SCB Detected READ	001 111
011	[OLF] – Open Load Failure	OLF Detected	SCB Detected SCG Detected READ	001 010 111
100	Diagnostic Complete – No Fault	OFF State No Fault <i>AND</i> ON State No Fault	SCB Detected SCG Detected OLF Detected READ	001 010 011 111
101	No SCB Detected	ON State No Fault	SCB Detected SCG Detected OLF Detected OFF State No Fault READ	001 010 011 100 111
110	No SCG/OLF Detected	OFF State No Fault	SCB Detected SCG Detected OLF Detected ON State No Fault READ	001 010 011 100 111
111	Diagnostic Not Complete	READ	SCB Detected & ENB = 0 SCG Detected & ENB = 0, VLOAD > VLDUV OLF Detected & ENB = 0, VLOAD > VLDUV ON State No Fault & ENB = 0 OFF State No Fault & ENB = 0, VLOAD > VLDUV	001 010 011 101 110

Diagnostic Status and Protection Interactions

The following figures are graphical representations of some interactions between diagnostics and protections.

The following assumptions apply:

- ENB = 0
- SPI Response is shown in-frame
 - ◆ Actual NCV7520 response is **one frame behind**
- SPI Frames are always valid
 - ◆ Integer multiples of 16 SCLK cycles
 - ◆ No parity errors

NCV7520

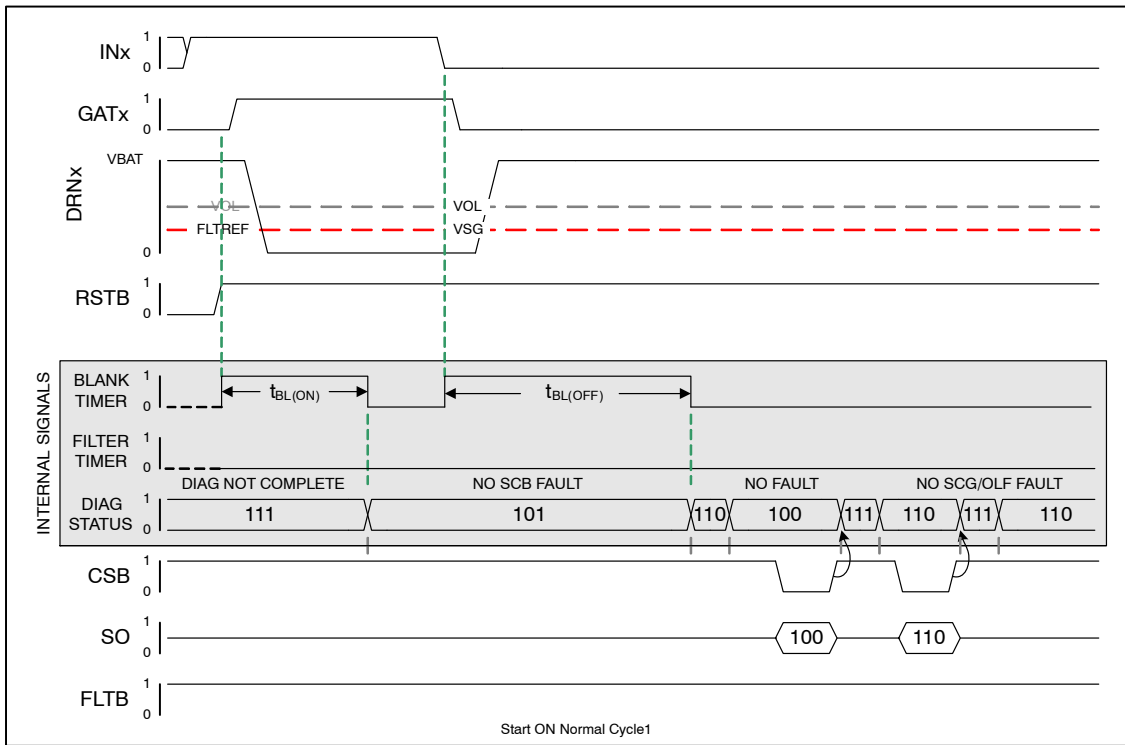

Figure 19. Normal Start-up out of Reset with Input High – Diagnostics Complete, No Fault

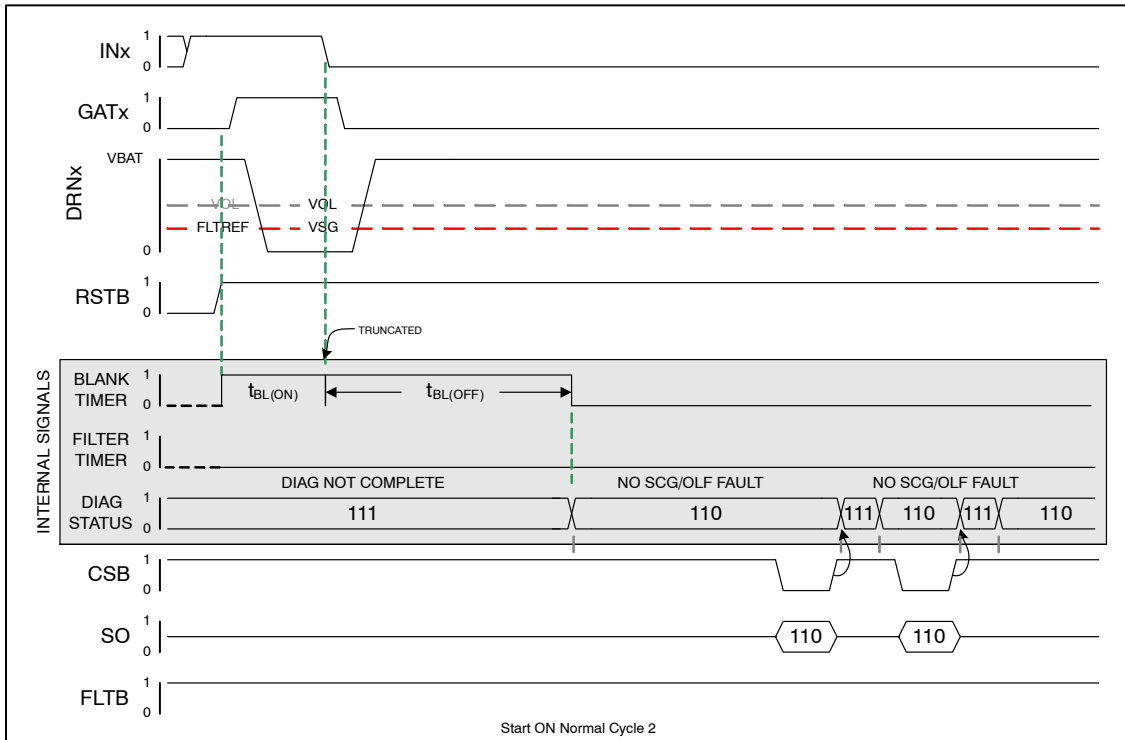

Figure 20. Normal Start-up Out of Reset with Input High, $t_{BL(ON)}$ Truncated – SCB Not Checked

NCV7520

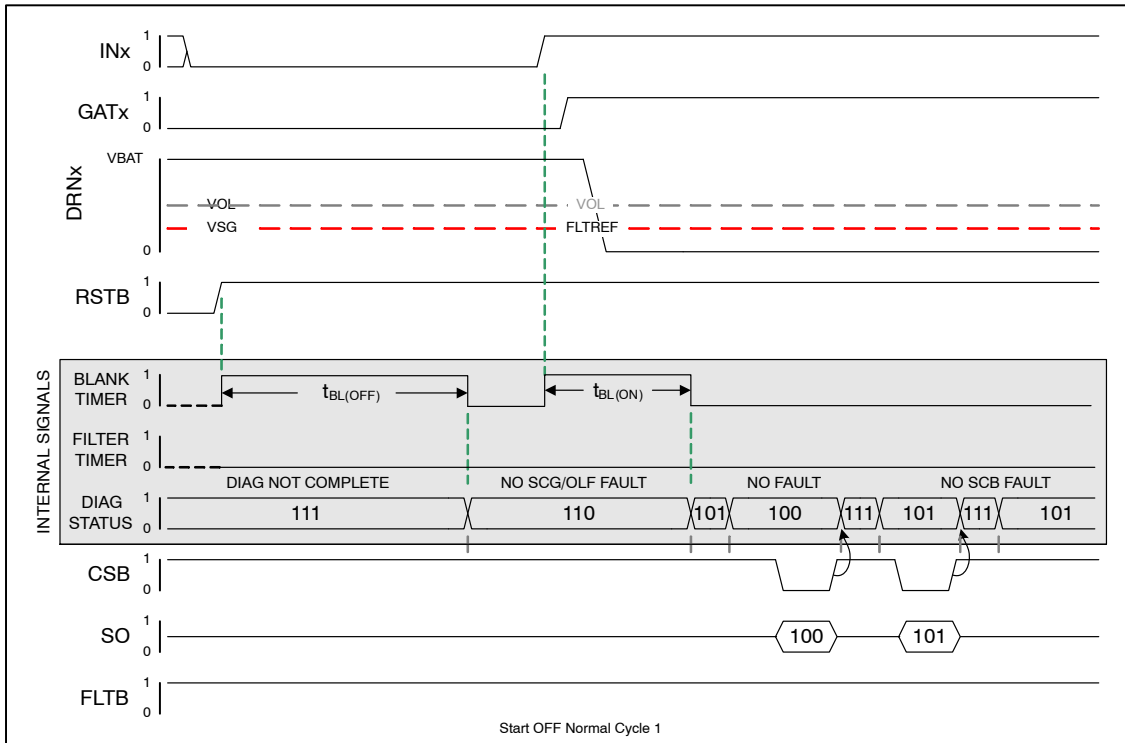

Figure 21. Normal Start-up Out of Reset with Input Low – Diagnostics Complete, No Fault

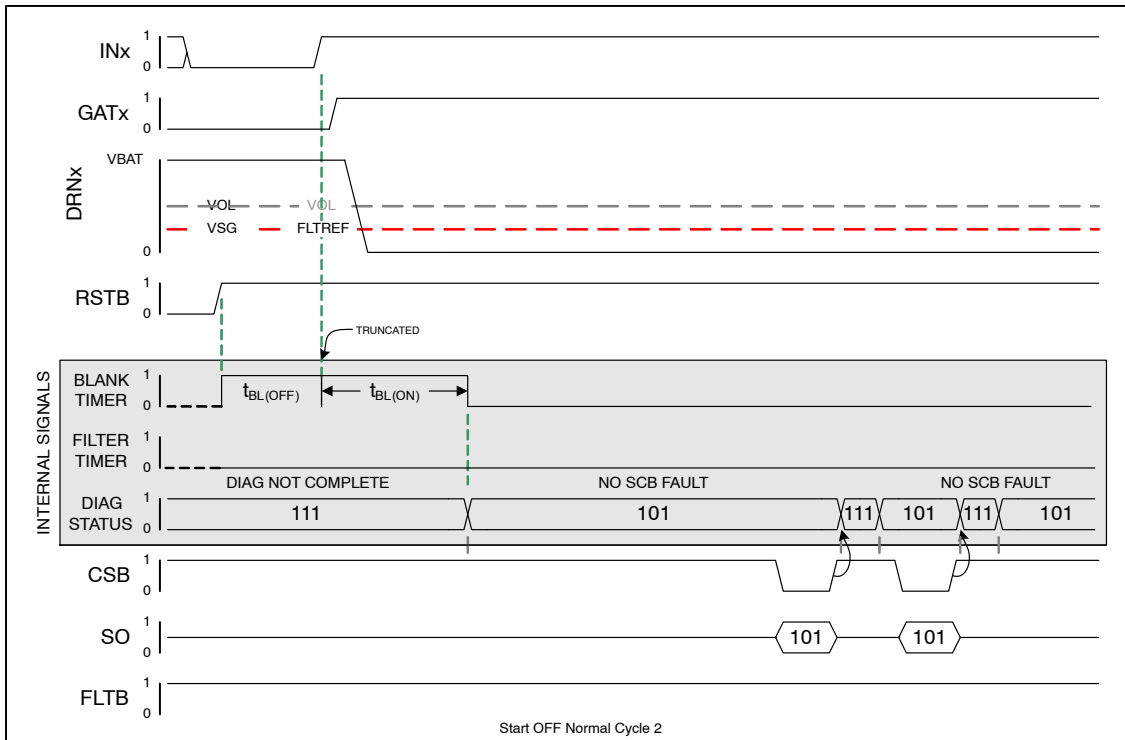

Figure 22. Normal Start-up Out of Reset with Input Low, $t_{BL(OFF)}$ Truncated – SCG/OLF Not Checked

NCV7520

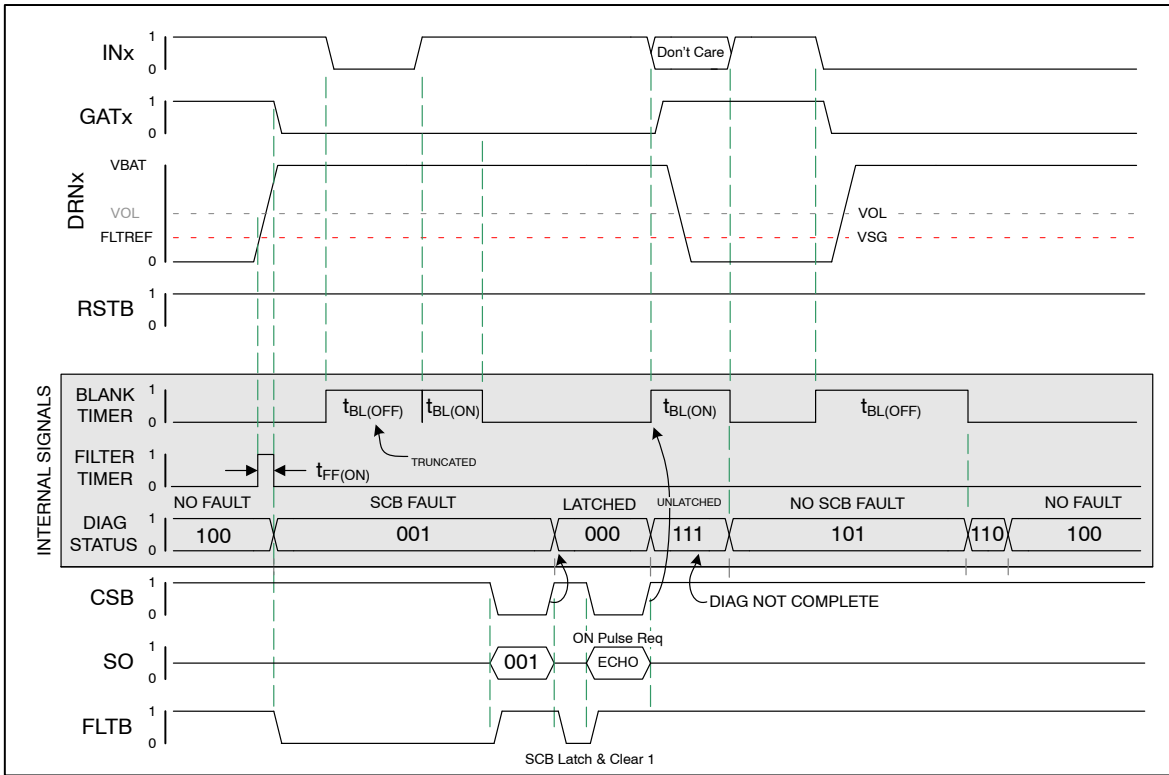

Figure 23. SCB Latch-off & Recovery – Read Status & Request ON Pulse

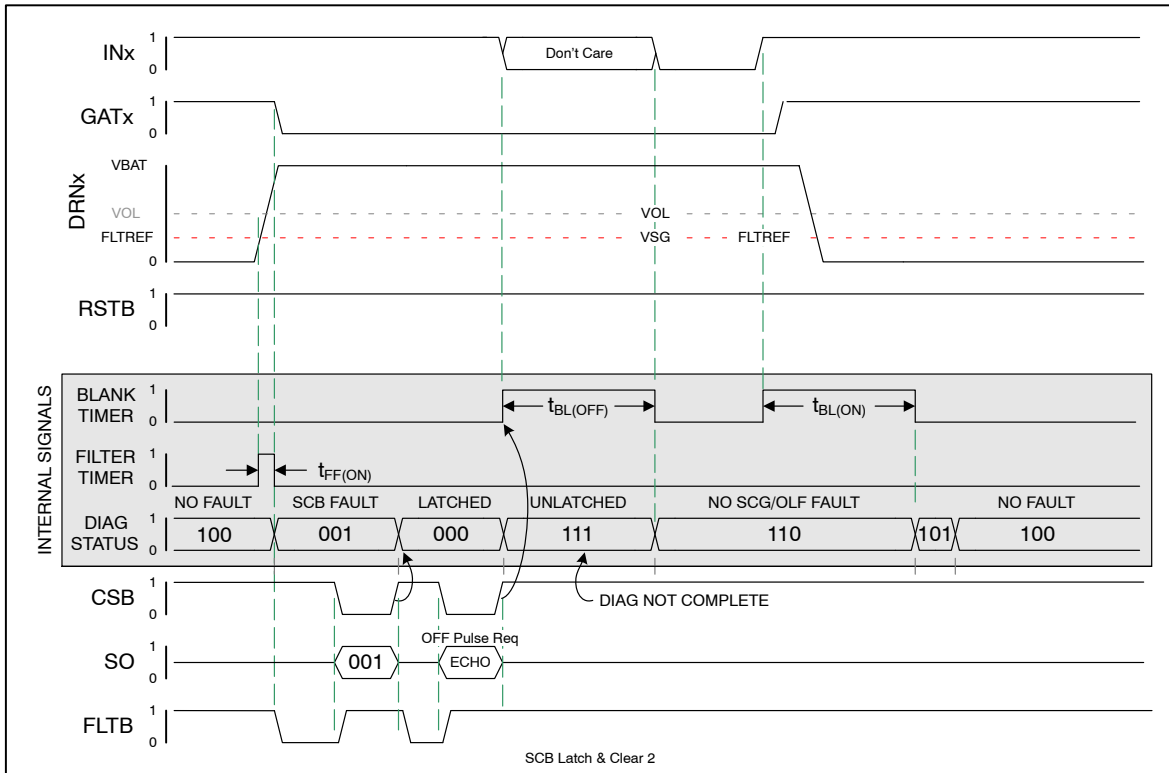

Figure 24. SCB Latch-off & Recovery – Read Status & Request OFF Pulse

NCV7520

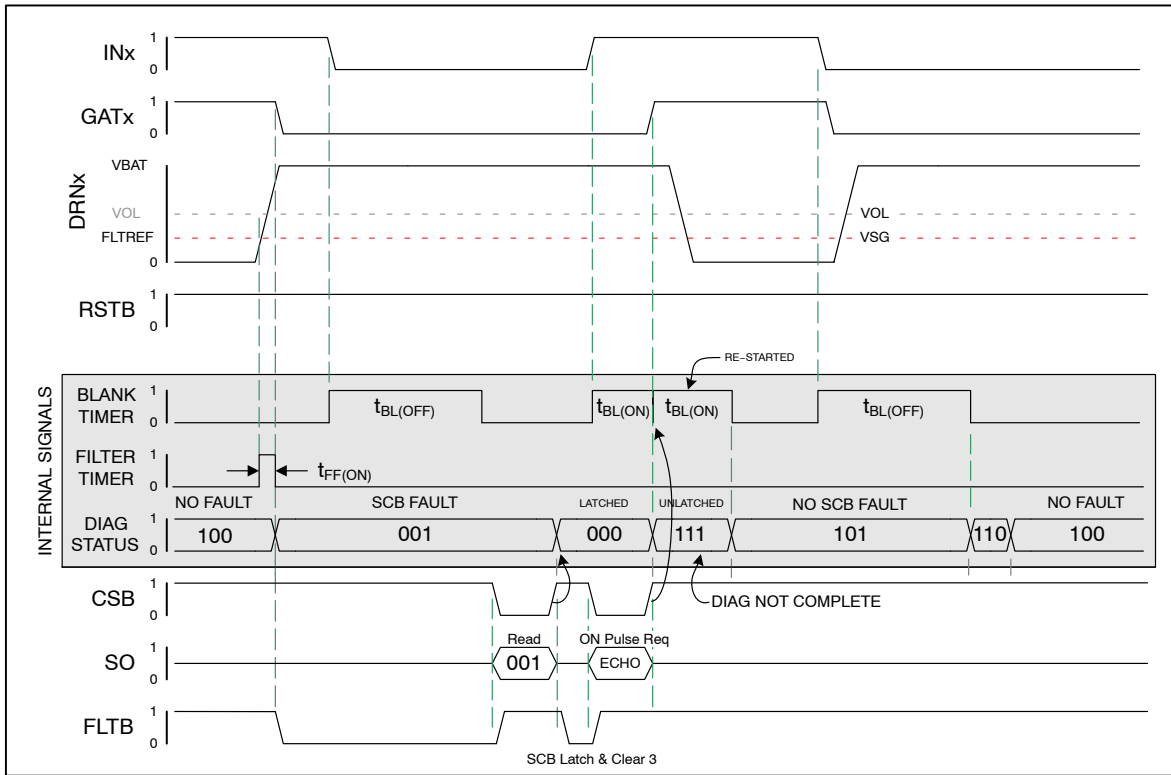

Figure 25. SCB Latch-off & Recovery – Read Status & Request ON Pulse (Timer Running)

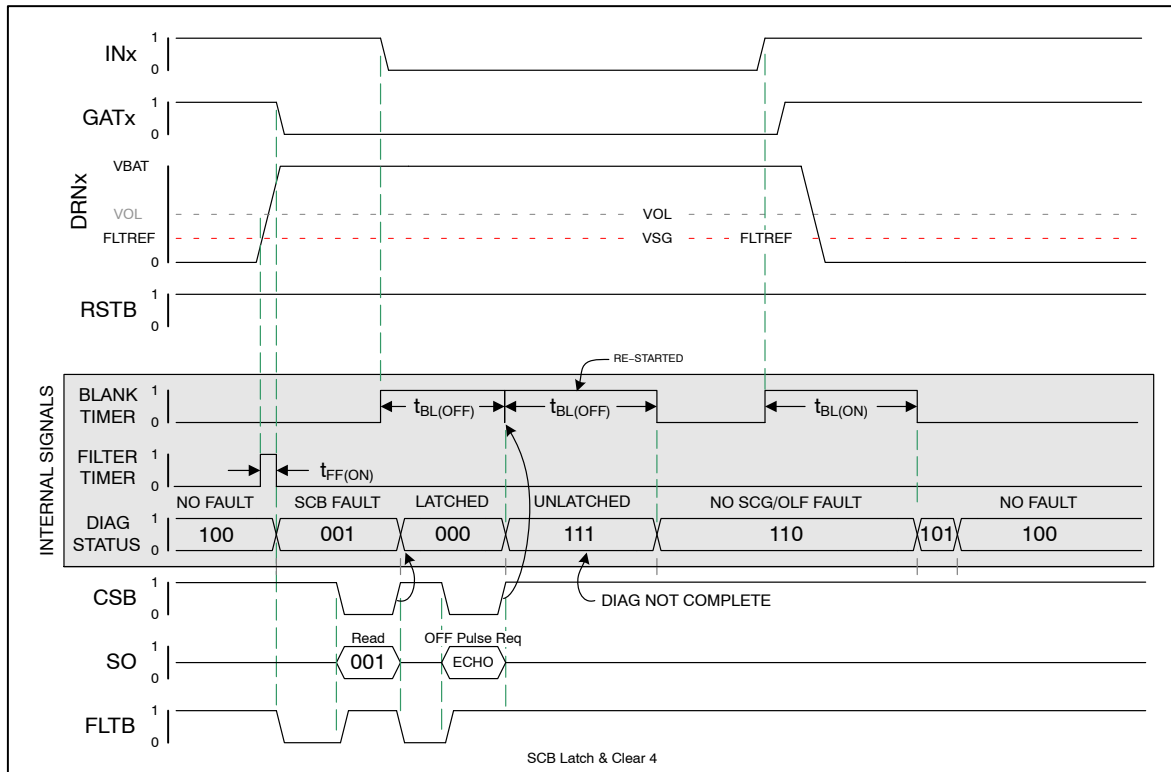

Figure 26. SCB Latch-off & Recovery – Read Status & Request OFF Pulse (Timer Running)

NCV7520

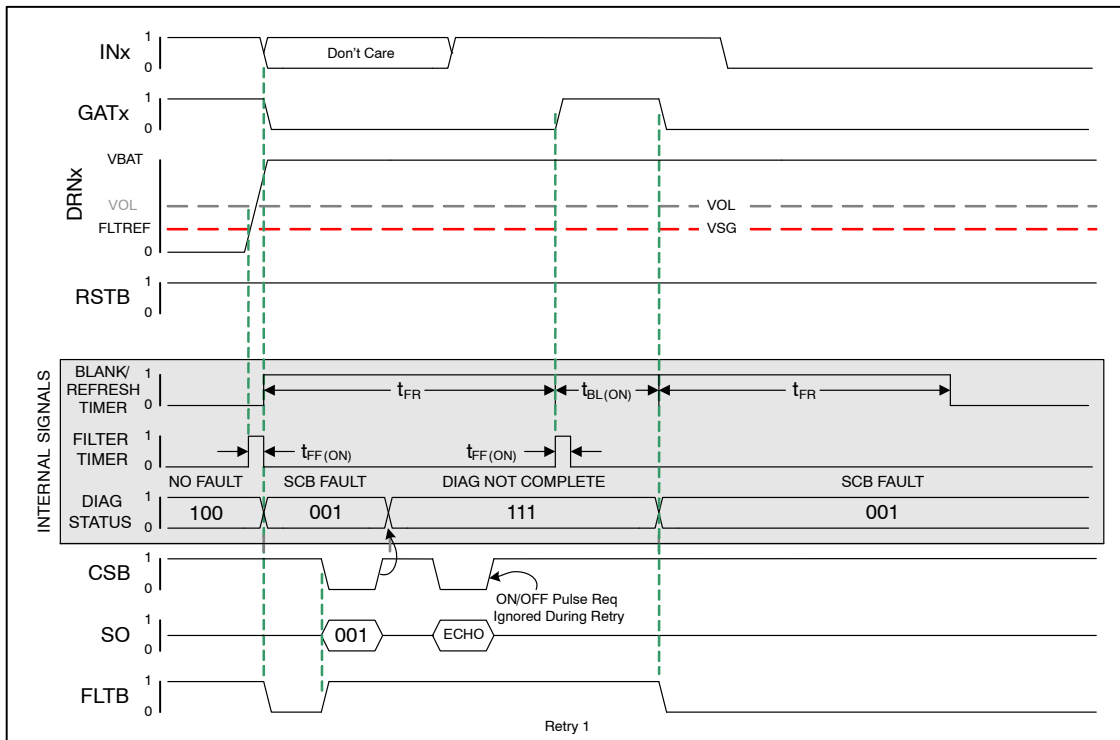

Figure 27. Auto-retry Timer Started, INx Went Low During Second Retry – Retry Timer Runs to Completion

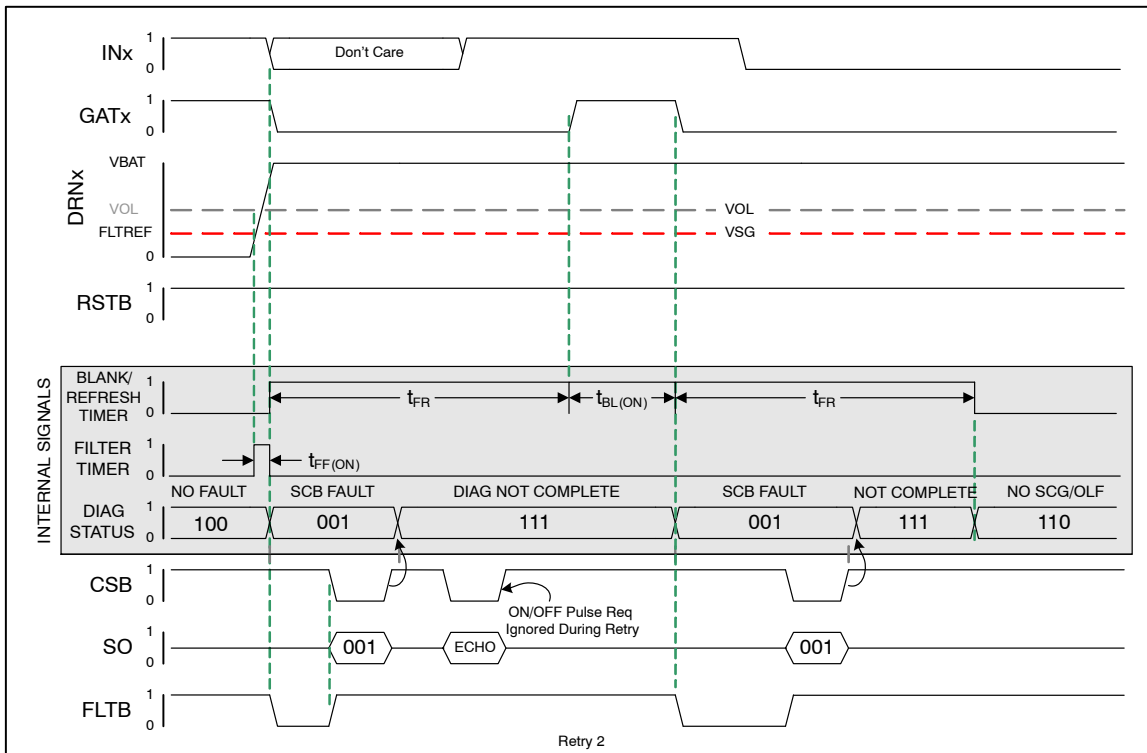

Figure 28. Auto-retry Timer Started, INx Went Low During Second Retry – Retry Timer Runs to Completion Status Read Clears SCB, Allows OFF-state Status Update

NCV7520

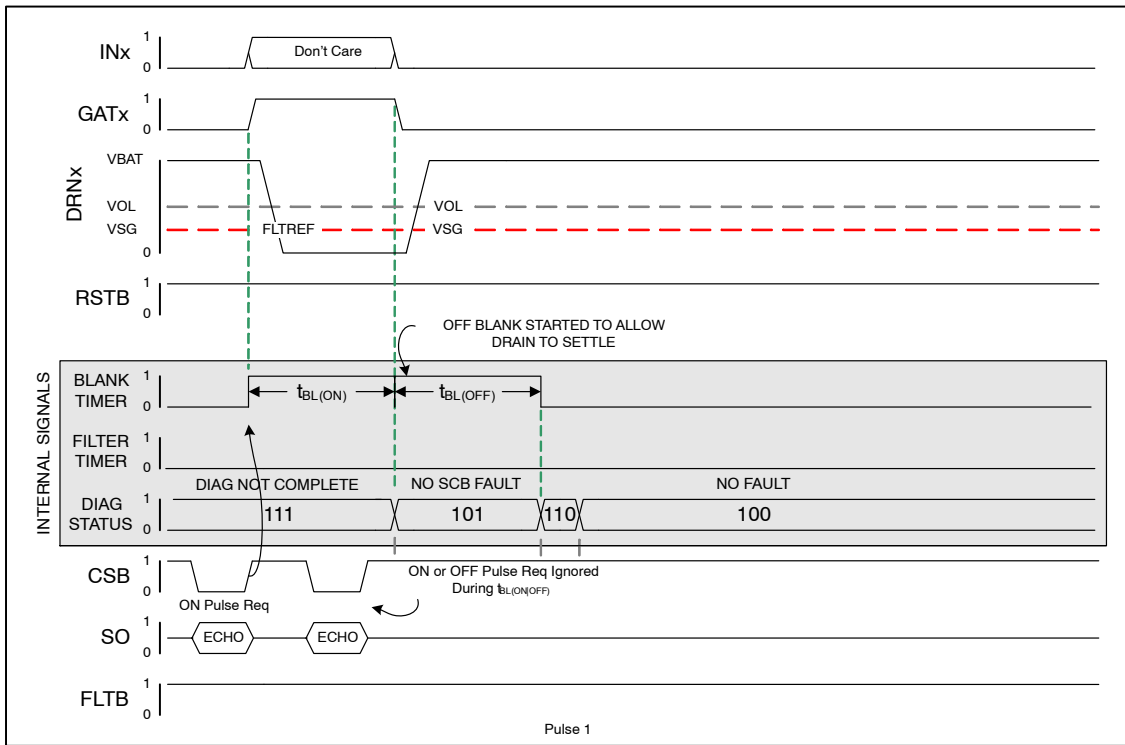

Figure 29. Normal ON Pulse Request & Second Request Ignored – INx Remains in Low State at End of Pulse

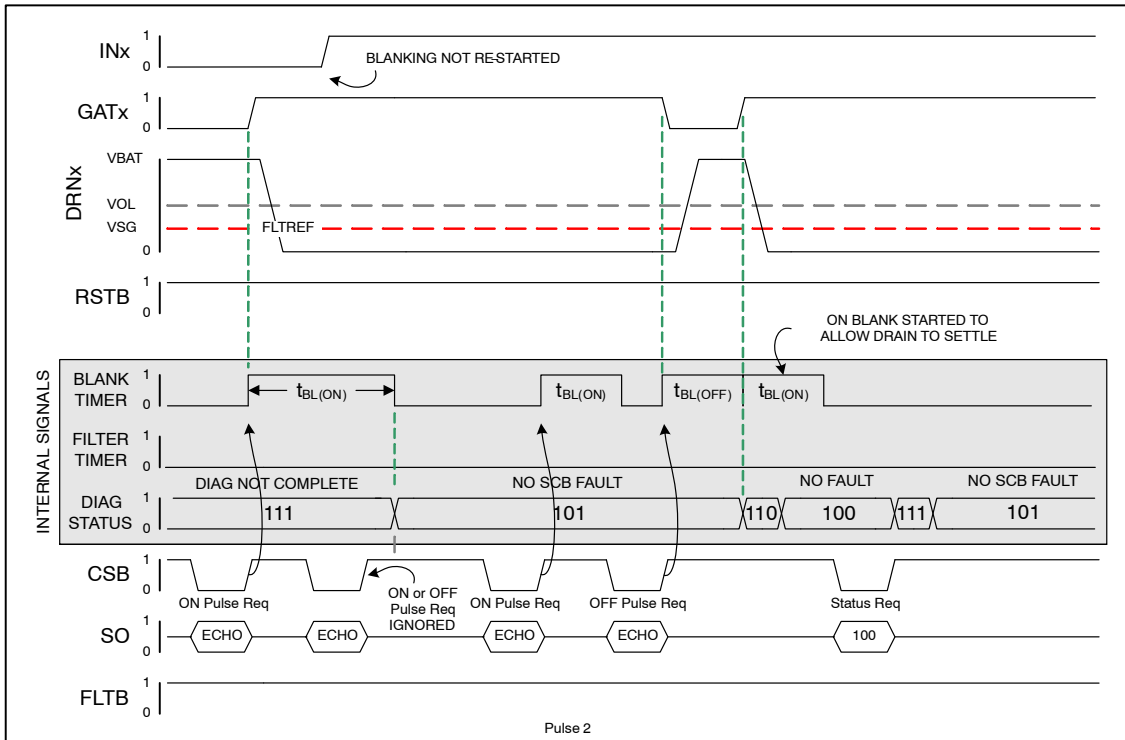

Figure 30. Normal ON Pulse Request & Second Request Ignored – INx State Change During First Pulse Execution, Normal OFF Pulse Request

NCV7520

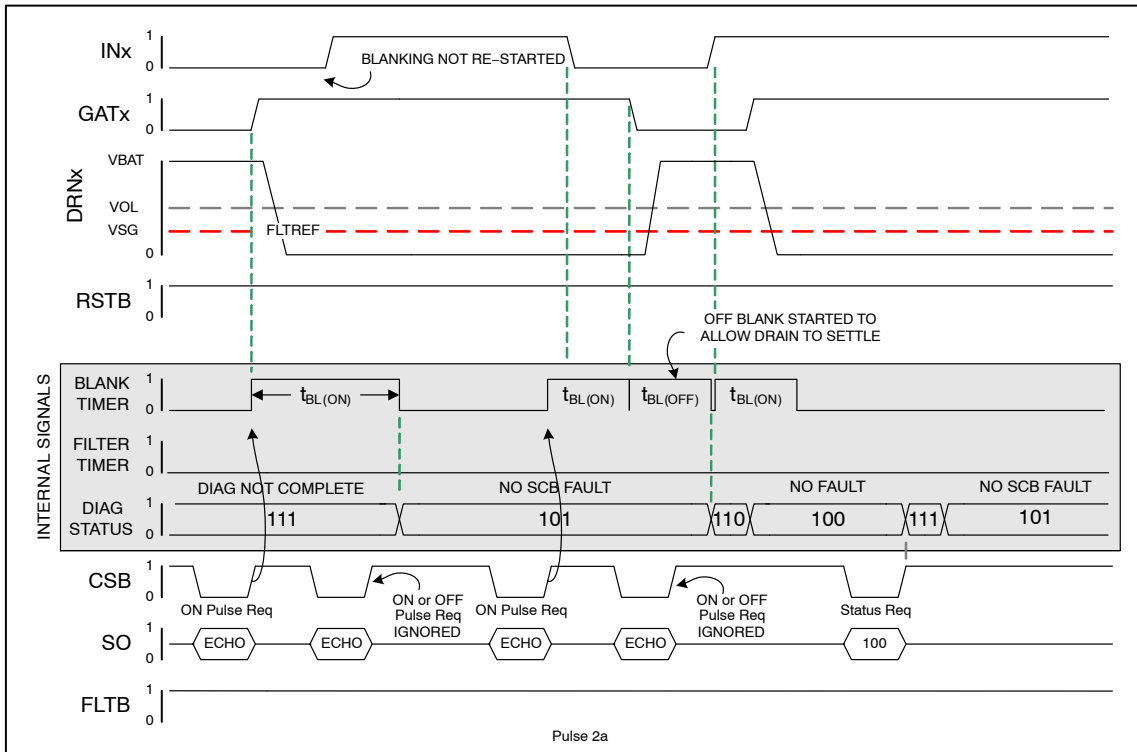

Figure 31. Normal ON Pulse Request & Second Request Ignored, Normal ON Pulse Request, INx State Change During Normal Pulse Executions

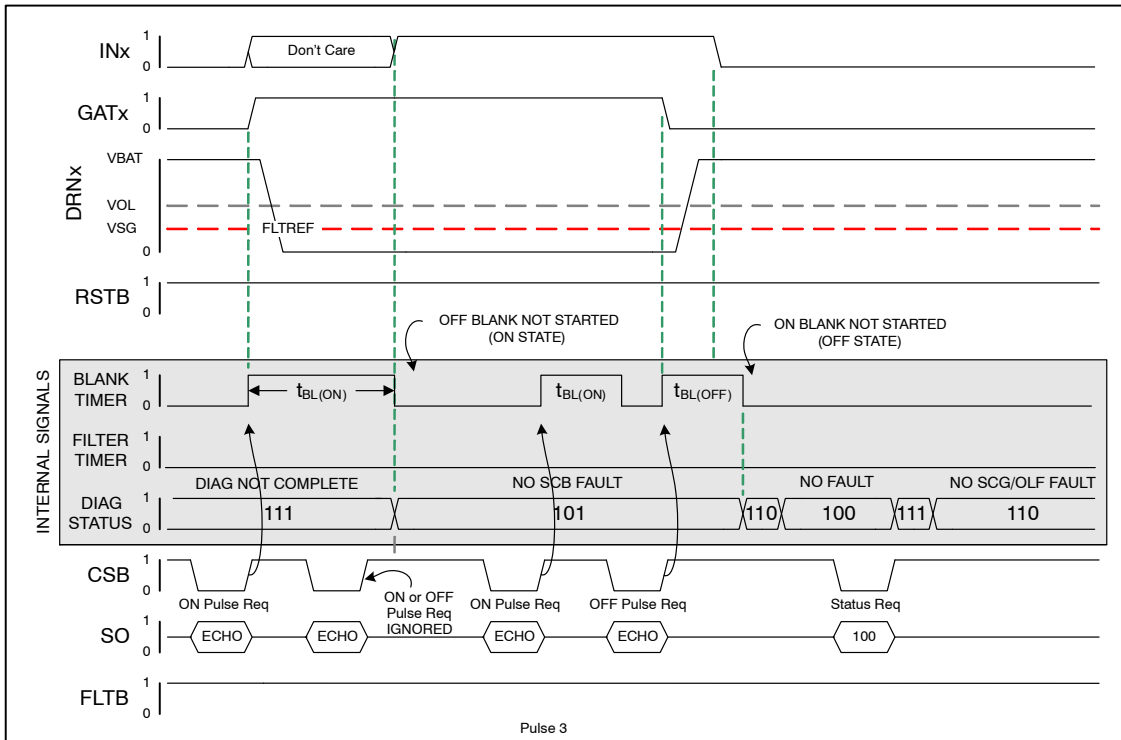

Figure 32. Normal ON Pulse Request & Second Request Ignored, Normal OFF Pulse Request, INx State Change During Normal Pulse Executions and Goes Low During OFF Pulse

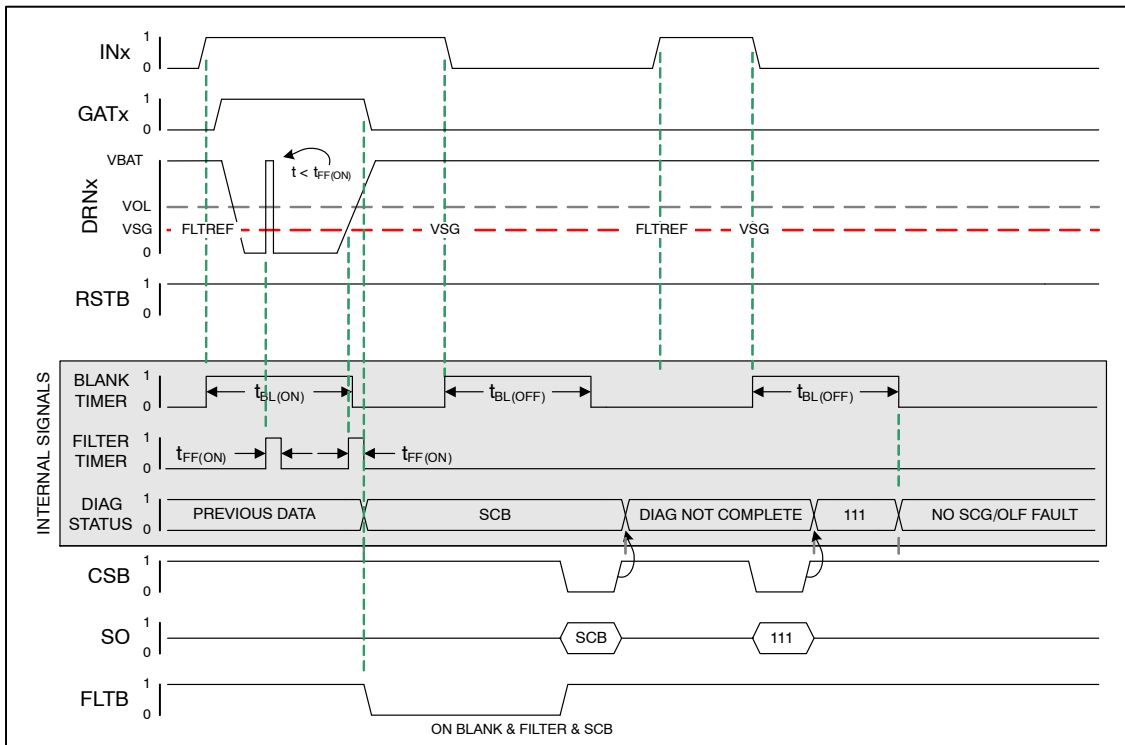

Figure 33. Filter Timer Started During Blank Timer Because of Intermittent SCB, Re-started Just Before End of Blank Timer – SCB Latch-off Time Extended

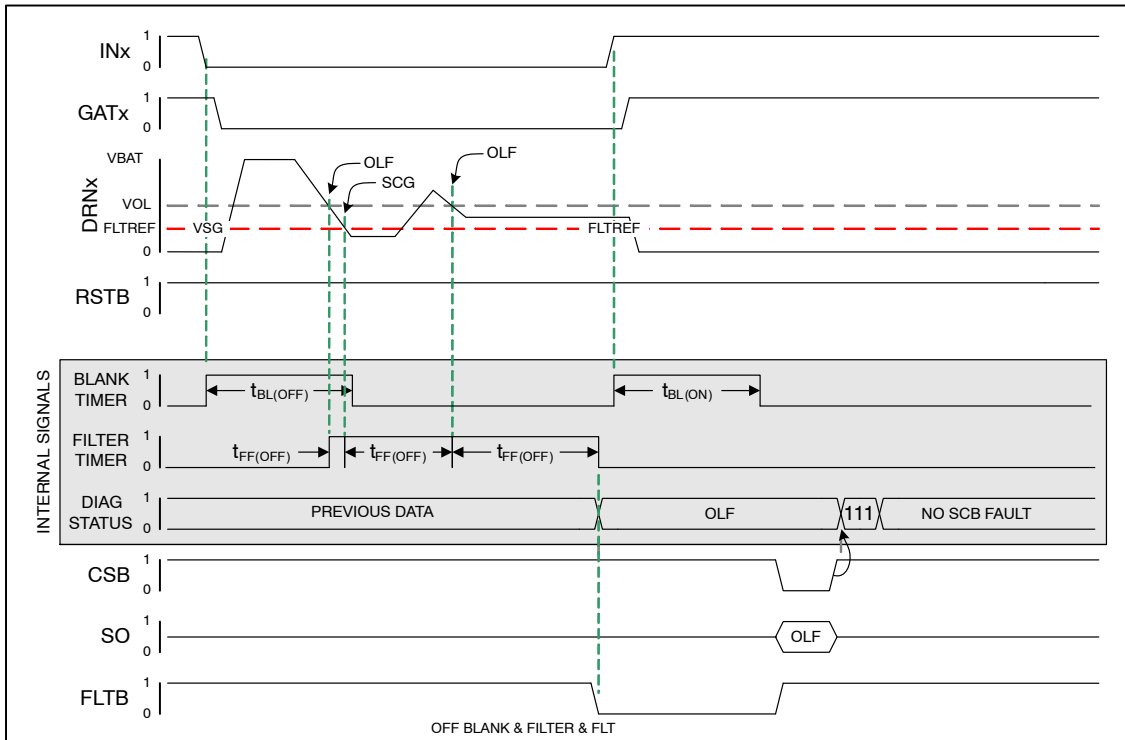

Figure 34. Filter Timer Started When Falling Through OLF Threshold During Blank Timer, Re-started When Falling Through SCG Threshold, Re-started When Falling Through OLF Threshold – OFF-State Diagnostic Status Acquisition Time Extended by Filter Timer

NCV7520

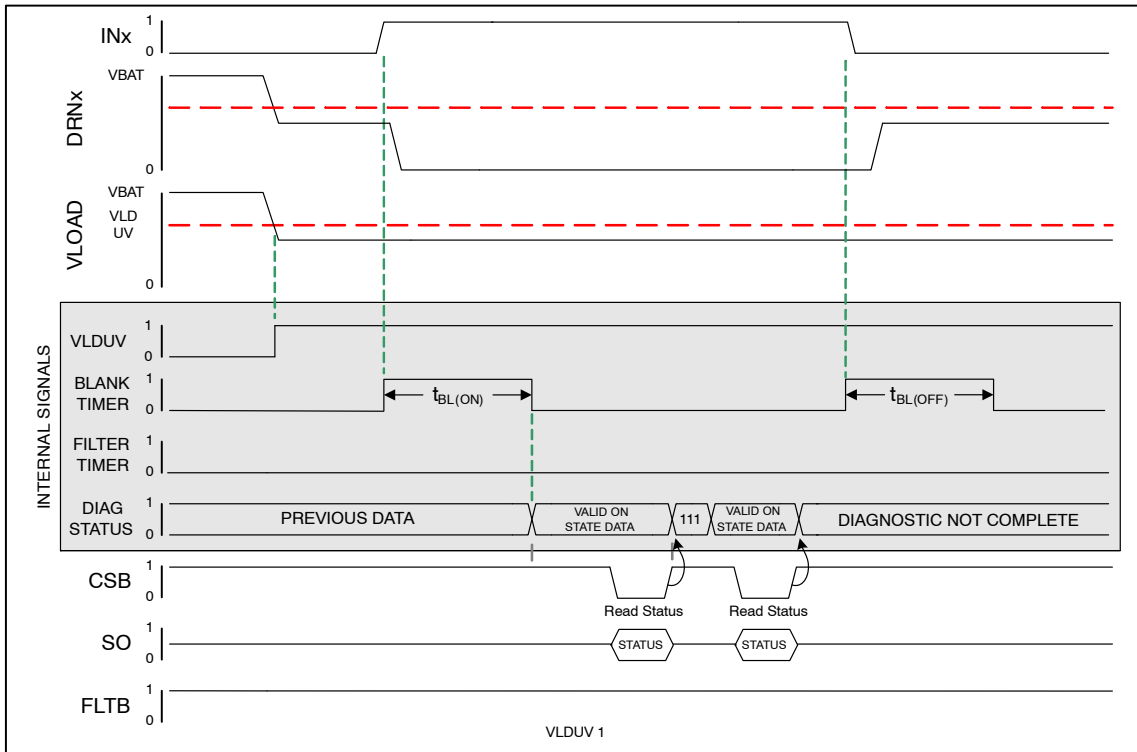

Figure 35. OFF-State Diagnostic Status is Suppressed While in VLOAD Undervoltage – ON-State Diagnostics Remain Functional

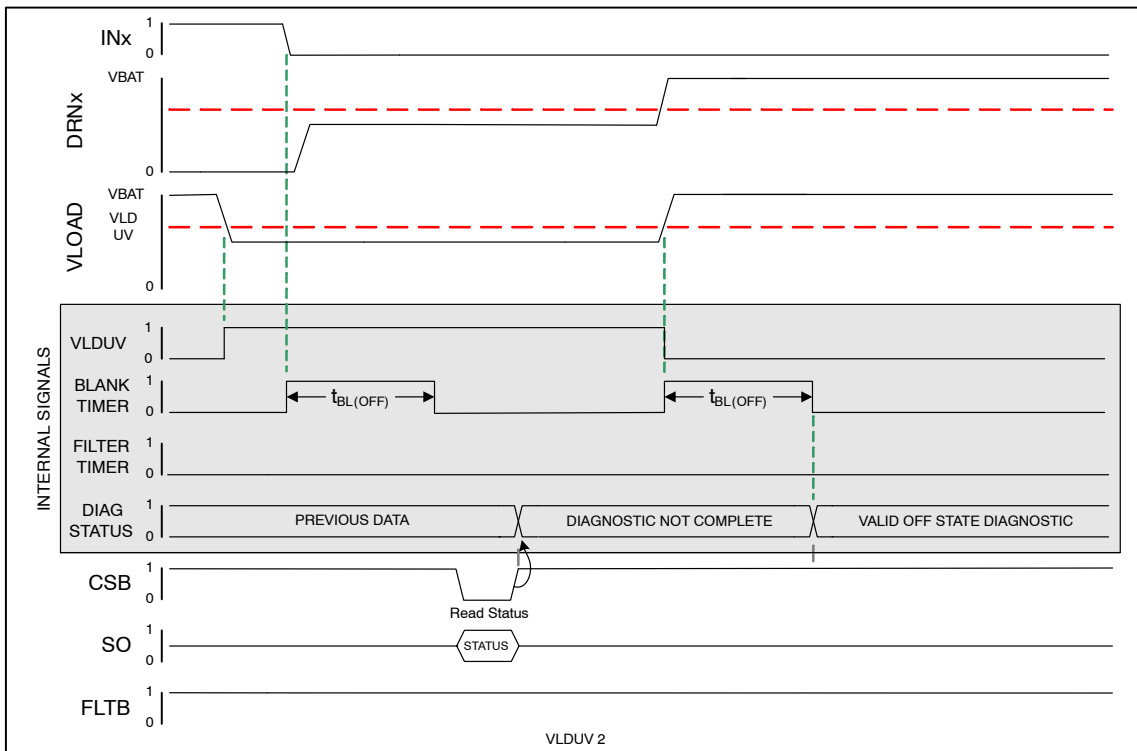

Figure 36. OFF-State Diagnostic Starts When Recovery From Undervoltage Occurs

FLEXMOS is trademark of Semiconductor Components Industries, LLC dba "onsemi" or its affiliates and/or subsidiaries in the United States and/or other countries.

NCV7520

REVISION HISTORY

Revision	Description of Changes	Date
1	Rebranded the Data Sheet to onsemi format.	1/12/2026
2	NCV7520FPR2G OPN Marked as Discontinued.	4/13/2026

This document has undergone updates prior to the inclusion of this revision history table. The changes tracked here only reflect updates made on the noted approval dates.

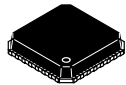

SCALE 2:1

QFN32 5x5, 0.5P (PUNCHED)
CASE 485CZ
ISSUE A

DATE 29 JUL 2013

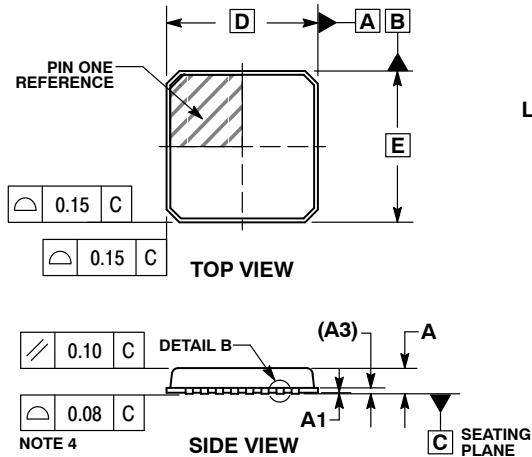

- NOTES:
1. DIMENSIONING AND TOLERANCING PER ASME Y14.5M, 1994.
 2. CONTROLLING DIMENSIONS: MILLIMETERS.
 3. DIMENSION b APPLIES TO PLATED TERMINAL AND IS MEASURED BETWEEN 0.15 AND 0.30 mm FROM THE TERMINAL TIP.
 4. COPLANARITY APPLIES TO THE EXPOSED PAD AS WELL AS THE TERMINALS.

MILLIMETERS		
DIM	MIN	MAX
A	0.80	0.90
A1	---	0.05
A3	0.20	REF
b	0.20	0.30
D	5.00	BSC
D2	3.20	3.40
E	5.00	BSC
E2	3.20	3.40
e	0.50	BSC
L	0.30	0.50

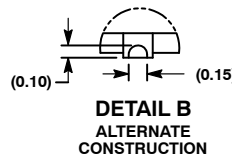

GENERIC MARKING DIAGRAM*

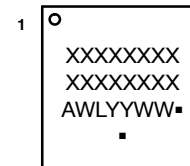

- XXXXX = Specific Device Code
- A = Assembly Location
- WL = Wafer Lot
- YY = Year
- WW = Work Week
- G = Pb-Free Package

(Note: Microdot may be in either location)

*This information is generic. Please refer to device data sheet for actual part marking.

Pb-Free indicator, "G" or microdot "■", may or may not be present.

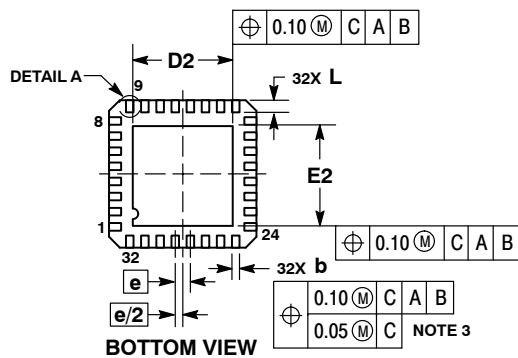

RECOMMENDED SOLDERING FOOTPRINT

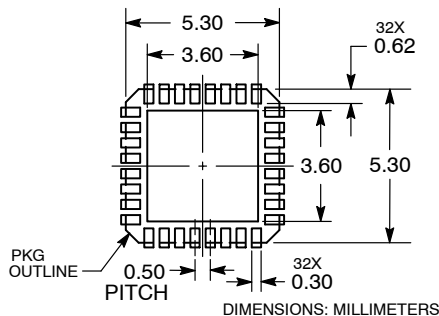

DOCUMENT NUMBER:	98AON87072E	Electronic versions are uncontrolled except when accessed directly from the Document Repository. Printed versions are uncontrolled except when stamped "CONTROLLED COPY" in red.
DESCRIPTION:	QFN32 5x5, 0.5P (PUNCHED)	PAGE 1 OF 1

onsemi and Onsemi are trademarks of Semiconductor Components Industries, LLC dba onsemi or its subsidiaries in the United States and/or other countries. onsemi reserves the right to make changes without further notice to any products herein. onsemi makes no warranty, representation or guarantee regarding the suitability of its products for any particular purpose, nor does onsemi assume any liability arising out of the application or use of any product or circuit, and specifically disclaims any and all liability, including without limitation special, consequential or incidental damages. onsemi does not convey any license under its patent rights nor the rights of others.

onsemi, **Onsemi**, and other names, marks, and brands are registered and/or common law trademarks of Semiconductor Components Industries, LLC dba "**onsemi**" or its affiliates and/or subsidiaries in the United States and/or other countries. **onsemi** owns the rights to a number of patents, trademarks, copyrights, trade secrets, and other intellectual property. A listing of **onsemi**'s product/patent coverage may be accessed at www.onsemi.com/site/pdf/Patent-Marking.pdf. **onsemi** reserves the right to make changes at any time to any products or information herein, without notice. The information herein is provided "as-is" and **onsemi** makes no warranty, representation or guarantee regarding the accuracy of the information, product features, availability, functionality, or suitability of its products for any particular purpose, nor does **onsemi** assume any liability arising out of the application or use of any product or circuit, and specifically disclaims any and all liability, including without limitation special, consequential or incidental damages. Buyer is responsible for its products and applications using **onsemi** products, including compliance with all laws, regulations and safety requirements or standards, regardless of any support or applications information provided by **onsemi**. "Typical" parameters which may be provided in **onsemi** data sheets and/or specifications can and do vary in different applications and actual performance may vary over time. All operating parameters, including "Typicals" must be validated for each customer application by customer's technical experts. **onsemi** does not convey any license under any of its intellectual property rights nor the rights of others. **onsemi** products are not designed, intended, or authorized for use as a critical component in life support systems or any FDA Class 3 medical devices or medical devices with a same or similar classification in a foreign jurisdiction or any devices intended for implantation in the human body. Should Buyer purchase or use **onsemi** products for any such unintended or unauthorized application, Buyer shall indemnify and hold **onsemi** and its officers, employees, subsidiaries, affiliates, and distributors harmless against all claims, costs, damages, and expenses, and reasonable attorney fees arising out of, directly or indirectly, any claim of personal injury or death associated with such unintended or unauthorized use, even if such claim alleges that **onsemi** was negligent regarding the design or manufacture of the part. **onsemi** is an Equal Opportunity/Affirmative Action Employer. This literature is subject to all applicable copyright laws and is not for resale in any manner.

ADDITIONAL INFORMATION

TECHNICAL PUBLICATIONS:

Technical Library: www.onsemi.com/design/resources/technical-documentation
onsemi Website: www.onsemi.com

ONLINE SUPPORT: www.onsemi.com/support

For additional information, please contact your local Sales Representative at www.onsemi.com/support/sales

