

Operational Amplifier, 36 V, 3 MHz, 0.95 mV Input Offset Voltage, Rail-to-Rail

NCS20231, NCV20231

The NCS2023x series of op amps feature a wide supply range of 2.7 V to 36 V with an input offset voltage as low as ± 0.95 mV max. These op amps are available in single channel configurations. Automotive qualified options are available under the NCV prefix with an optional extended operating temperature range from -40 °C to 150 °C. All other versions are specified over the operating temperature range from -40 °C to 125 °C.

Features

- Supply Voltage Range: 2.7 V to 36 V
- Temperature Range: -40 °C to 150 °C
- Unity Gain Bandwidth: 3 MHz
- Input Offset Voltage: ± 1.2 mV max, $T_A = -40$ to 150 °C
- Input Offset Voltage Drift: ± 2 μ V/°C max
- Common-Mode Input Voltage Range
 - ◆ Optimal: $V_{SS} - 0.1$ to $V_{DD} - 2$ V
 - ◆ Functional: $V_{SS} - 0.1$ to $V_{DD} + 0.1$ V
- NCV Prefix for Automotive and Other Applications Requiring Unique Site and Control Change Requirements; AEC-Q100 Qualified and PPAP Capable
- These Devices are Pb-Free, Halogen Free/BFR Free and are RoHS Compliant

Applications

- Telecom Equipment
- Power Supply Designs
- Diesel Injection Control
- Automotive
- Motor Control

PIN CONNECTIONS

Single Channel

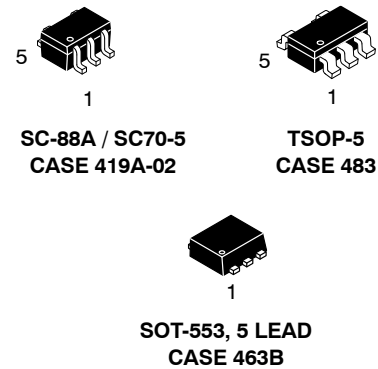
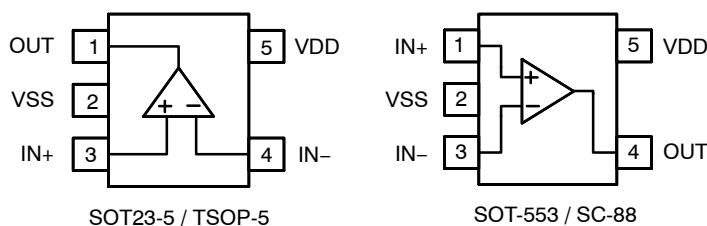

DEVICE MARKING INFORMATION

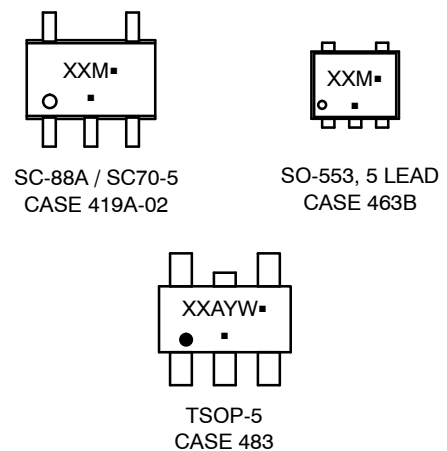

- XX = Specific Device Code
- A = Assembly Location
- Y = Year
- W = Work Week
- M = Date Code
- G or ■ = Pb-Free Package

(Note: Microdot may be in either location)

ORDERING INFORMATION

See detailed ordering and shipping information on page 12 of this data sheet.

ABSOLUTE MAXIMUM RATINGS (Note 1)

Parameter	Symbol	Value	Unit
Supply Voltage Range ($V_{DD} - V_{SS}$)	V_S	-0.3 to 40	V
Input Common-Mode Voltage	V_{CM}	$V_{SS} - 0.2$ to $V_{DD} + 0.2$	V
Differential Input Voltage	V_{ID}	$\pm V_S$	V
Maximum Input Current	I_I	± 10	mA
Maximum Output Current	I_O	± 100	mA
Continuous Total Power Dissipation	P_D	200	mW
Maximum Junction Temperature	$T_{J(max)}$	150	°C
Storage Temperature Range	T_{STG}	-65 to 150	°C
ESD Capability, Human Body Model (Note 2)	HBM	± 2000	V
ESD Capability, Charge Device Model (Note 2)	CDM	± 1000	V
Moisture Sensitivity Level	MSL	Level 1	
Lead Temperature Soldering Reflow (SMD Styles Only), Pb-Free Versions (Note 3)	T_{SLD}	260	°C

Stresses exceeding those listed in the Maximum Ratings table may damage the device. If any of these limits are exceeded, device functionality should not be assumed, damage may occur and reliability may be affected.

1. Refer to ELECTRICAL CHARACTERISTICS and APPLICATION INFORMATION for Safe Operating Area
2. This device series incorporates ESD protection and is tested by the following methods:
 ESD Human Body Model tested per JEDEC standard JS-001-2017 (AEC-Q100-002)
 ESD Charged Device Model tested per JEDEC standard JS-002-2014 (AEC-Q100-011)
3. For information, please refer to our Soldering and Mounting Techniques Reference Manual, SOLDERRM/D

THERMAL CHARACTERISTICS (Note 4)

Package	θ_{JA} Junction-to-Ambient Thermal Resistance	Ψ_{JT} Junction-to-Case Top Thermal Characteristic	Ψ_{JB} Junction-to-Board Thermal Characteristic	Unit
TSOP-5 / SOT23-5	254	78	150	°C/W
SC-88A / SC-70-5 / SOT-353	902	70	810	°C/W
SOT-553	238	14	134	°C/W

4. Thermal parameters are based on a 2s2p board following JESD51-7 (JEDEC)

RECOMMENDED OPERATING RANGES (Note 5)

Parameter	Symbol	Min	Max	Unit
Supply Voltage ($V_{DD} - V_{SS}$)	V_S	2.7	36	V
Differential Input Voltage ($V_{IN+} - V_{IN-}$)	V_{ID}	-	± 5 (Note 6)	V
Input Common-Mode Range (Note 7)	V_{CM}	$V_{SS} - 0.1$	$V_{DD} - 2 V$	V

Functional operation above the stresses listed in the Recommended Operating Ranges is not implied. Extended exposure to stresses beyond the Recommended Operating Ranges limits may affect device reliability.

5. Refer to ELECTRICAL CHARACTERISTICS and APPLICATION INFORMATION for Safe Operating Area
6. The differential voltage may not exceed the supply voltage, $\pm V_S$. For supplies greater than $V_S = 5 V$, differential voltages up to $\pm V_S$ will consume more input current. See APPLICATION INFORMATION.
7. The specified input common mode range yields the best performance. However, the input common mode range is functional up to $V_{DD} + 0.1 V$. See APPLICATION INFORMATION.

NCS20231, NCV20231

ELECTRICAL CHARACTERISTICS ($V_S = 2.7\text{ V to }36\text{ V}$)

At $T_A = +25\text{ }^\circ\text{C}$, $R_L = 10\text{ k}\Omega$ connected to midsupply, $V_{CM} = V_{OUT} = \text{midsupply}$, unless otherwise noted.

Boldface limits apply over the specified temperature range, guaranteed by characterization and/or design.

Parameter	Symbol	Conditions	Supply Voltage (V)	Temp ($^\circ\text{C}$)	Min	Typ	Max	Unit
INPUT CHARACTERISTICS								
Offset Voltage	V_{OS}	$V_{CM} = \text{mid-supply}$	2.7, 5, 10, 36	25	-	± 0.3	± 0.95	mV
				-40 to 125	-	-	± 1.2	
				-40 to 150	-	-	± 1.2	
Offset Voltage Drift over Temperature	dV_{OS}/dT	$V_{CM} = \text{mid-supply}$	2.7, 5, 10, 36	-40 to 125	-	± 0.5	± 2	$\mu\text{V}/^\circ\text{C}$
				-40 to 150	-	± 0.5	± 5	
Input Bias Current (Note 8)	I_{IB}		2.7, 5, 10, 36	25	-	± 5	± 60	pA
				-40 to 125	-	-	± 3000	
				150	-	± 10000	-	
Input Offset Current (Note 8)	I_{OS}		2.7	25	-	± 0.5	± 60	pA
				-40 to 125	-	-	± 500	
				-40 to 150	-	-	± 2000	
			5, 10	25	-	± 0.5	± 60	pA
				-40 to 125	-	-	± 800	
				-40 to 150	-	-	± 2500	
			36	25	-	± 0.5	± 60	pA
				-40 to 125	-	-	± 2000	
				-40 to 150	-	-	± 2500	
Input Capacitance	C_{IN}	IN+	2.7, 36	25	-	1	-	pF
		IN-	2.7, 36	25	-	6	-	
Common Mode Rejection Ratio	CMRR	$V_{CM} = V_{SS} - 0.1\text{ V to }V_{DD} - 2\text{ V}$	2.7	25	80	98	-	dB
				-40 to 125	75	-	-	
				-40 to 150	69	-	-	
			5 (Note 8)	25	90	105	-	
				-40 to 125	85	-	-	
				-40 to 150	80	-	-	
			10 (Note 8)	25	100	117	-	
				-40 to 125	100	-	-	
				-40 to 150	94	-	-	
			36	25	110	122	-	
-40 to 125	110	-		-				
-40 to 150	107	-		-				
		$V_{CM} = V_{SS} + 1.8\text{ V to }V_{DD} - 2.4\text{ V}$	36	25	117 (Note 8)	125	-	dB
EMI Rejection Ratio	EMIRR		2.7, 36	25	-	See Figure 29	-	dB

8. Guaranteed by design and/or characterization.

NCS20231, NCV20231

ELECTRICAL CHARACTERISTICS ($V_S = 2.7\text{ V to }36\text{ V}$) (continued)

At $T_A = +25\text{ }^\circ\text{C}$, $R_L = 10\text{ k}\Omega$ connected to midsupply, $V_{CM} = V_{OUT} = \text{midsupply}$, unless otherwise noted.

Boldface limits apply over the specified temperature range, guaranteed by characterization and/or design.

Parameter	Symbol	Conditions	Supply Voltage (V)	Temp ($^\circ\text{C}$)	Min	Typ	Max	Unit			
OUTPUT CHARACTERISTICS											
Open Loop Voltage Gain	A_{VOL}	$V_{CM} = \text{mid-supply}$	2.7	25	100	115	-	dB			
				-40 to 125	90	-	-				
				-40 to 150	90	-	-				
			5 (Note 9)	25	120	135	-				
				-40 to 125	115	-	-				
				-40 to 150	115	-	-				
			10 (Note 9)	25	130	145	-				
				-40 to 125	120	-	-				
				-40 to 150	120	-	-				
			36	25	135	154	-				
				-40 to 125	130	-	-				
				-40 to 150	130	-	-				
Open Loop Output Impedance	Z_{OUT}			-	-	See Figure 28	-	Ω			
High Level Output Voltage Swing from V_{DD}	$V_{DD}-V_{OH}$	$R_L = 10\text{ k}\Omega$	2.7, 5, 10, 36	25	-	60	80	mV			
				-40 to 125	-	-	120				
				-40 to 150	-	-	150				
			$I_{OUT} = 1\text{ mA}$	2.7, 5, 10, 36	25	-	40		60		
				-40 to 125	-	-	80				
				-40 to 150	-	-	100				
		$I_{OUT} = 5\text{ mA}$	10	25	-	165	200				
				-40 to 125	-	-	350				
				-40 to 150	-	-	400				
		Low Level Output Voltage Swing from V_{SS}	$V_{OL}-V_{SS}$	$R_L = 10\text{ k}\Omega$	2.7, 5, 10	25	-		16	30	mV
						-40 to 125	-		-	50	
						-40 to 150	-		-	50	
36	25				-	55	80				
	-40 to 125				-	-	250				
	-40 to 150				-	-	120				
$I_{OUT} = 1\text{ mA}$	2.7, 5, 10, 36				25	-	35	50			
					-40 to 125	-	-	80			
					-40 to 150	-	-	80			
$I_{OUT} = 5\text{ mA}$	10			25	-	150	170				
				-40 to 125	-	-	300				
				-40 to 150	-	-	300				
Output Current Capability	I_{OUT}			Output to V_{DD} rail, sinking current	2.7, 5, 10, 36	25	-	28	-	mA	
				Output to V_{SS} rail, sourcing current	2.7, 5, 10, 36	25	-	28	-		
Capacitive Load Drive	C_L			Phase margin = 35°	2.7 to 36	25	-	140	-	pF	

9. Guaranteed by design and/or characterization.

NCS20231, NCV20231

ELECTRICAL CHARACTERISTICS ($V_S = 2.7\text{ V to }36\text{ V}$) (continued)

At $T_A = +25\text{ }^\circ\text{C}$, $R_L = 10\text{ k}\Omega$ connected to midsupply, $V_{CM} = V_{OUT} = \text{midsupply}$, unless otherwise noted.

Boldface limits apply over the specified temperature range, guaranteed by characterization and/or design.

Parameter	Symbol	Conditions	Supply Voltage (V)	Temp ($^\circ\text{C}$)	Min	Typ	Max	Unit
-----------	--------	------------	--------------------	---------------------------	-----	-----	-----	------

DYNAMIC PERFORMANCE

Gain Bandwidth Product	GWBP	$C_L = 25\text{ pF}$	2.7, 5, 10, 36	25	–	3	–	MHz
Gain Margin	A_m	$C_L = 25\text{ pF}$	2.7, 5, 10, 36	25	–	16	–	dB
Phase Margin	Φ_m	$C_L = 25\text{ pF}$	2.7, 5, 10, 36	25	–	60	–	$^\circ$
Slew Rate	SR	Unity gain, $R_L = 2\text{ k}\Omega$	2.7, 5, 10, 36	25	–	4	–	$\text{V}/\mu\text{s}$
Settling Time to 0.1 %	t_s	$V_{IN} = 1\text{ V step}$	2.7	25	–	7	–	μs
		$V_{IN} = 3\text{ V step}$	5	25	–	7	–	
		$V_{IN} = 8\text{ V step}$	10	25	–	7	–	
		$V_{IN} = 10\text{ V step}$	36	25	–	6	–	
Settling Time to 0.01 %	t_s	$V_{IN} = 1\text{ V step}$	2.7	25	–	20	–	μs
		$V_{IN} = 3\text{ V step}$	5	25	–	10	–	
		$V_{IN} = 8\text{ V step}$	10	25	–	9	–	
		$V_{IN} = 10\text{ V step}$	36	25	–	9	–	

NOISE PERFORMANCE

Total Harmonic Distortion + Noise	THD+ N	$V_{IN} = 0.5\text{ V}_{pp}$, $f = 1\text{ kHz}$, $A_V = 1$	2.7	25	–	0.009	–	%
		$V_{IN} = 2.5\text{ V}_{pp}$, $f = 1\text{ kHz}$, $A_V = 1$	5	25	–	0.0004	–	
		$V_{IN} = 7.5\text{ V}_{pp}$, $f = 1\text{ kHz}$, $A_V = 1$	10	25	–	0.0002	–	
		$V_{IN} = 28.5\text{ V}_{pp}$, $f = 1\text{ kHz}$, $A_V = 1$	36	25	–	0.0002	–	
Voltage Noise Density	e_n	$f = 1\text{ kHz}$	2.7, 5, 10, 36	25	–	20	–	$\text{nV}/\sqrt{\text{Hz}}$
		$f = 10\text{ kHz}$			–	20	–	
Current Noise Density	i_n	$f = 1\text{ kHz}$	2.7, 5, 10, 36	25	–	30	–	$\text{fA}/\sqrt{\text{Hz}}$
Voltage Noise, Peak to Peak	e_{pp}	$f_{IN} = 0.1\text{ Hz to }10\text{ Hz}$	2.7, 5, 10, 36	25	–	700	–	nV_{pp}

POWER SUPPLY

Power Supply Rejection Ratio	PSRR	$V_S = 2.7\text{ V to }36\text{ V}$	2.7, 36	25	125	138	–	dB
				–40 to 125	120	–	–	
				–40 to 150	120	–	–	
Quiescent Current	I_Q	No load	2.7, 5	25	–	0.37	0.595	mA
				–40 to 125	–	–	0.650	
				–40 to 150	–	–	0.7	
			10	25	–	0.375	0.595	
				–40 to 125	–	–	0.650	
				–40 to 150	–	–	0.75	
			36	25	–	0.41	0.595	
				–40 to 125	–	–	0.650	
				–40 to 150	–	–	0.8	

Product parametric performance is indicated in the Electrical Characteristics for the listed test conditions, unless otherwise noted. Product performance may not be indicated by the Electrical Characteristics if operated under different conditions.

Typical Characteristics

Typical Performance at $T_A = 25\text{ }^\circ\text{C}$, $V_{CM} = \text{mid-supply}$, $C_L = 20\text{ pF}$, $R_L = 10\text{ k}\Omega$ to mid-supply, unless otherwise noted

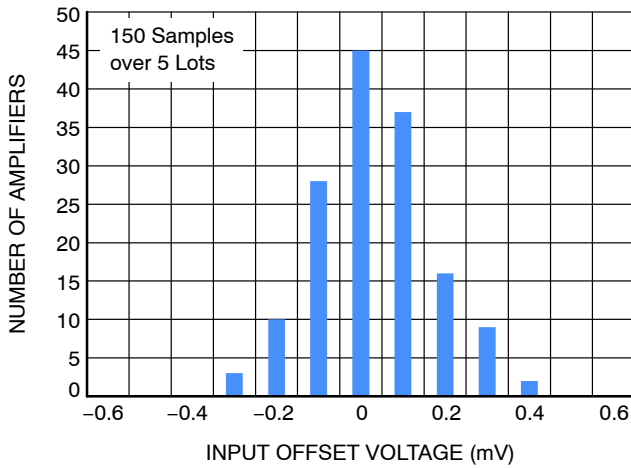

Figure 1. Input Offset Voltage Distribution

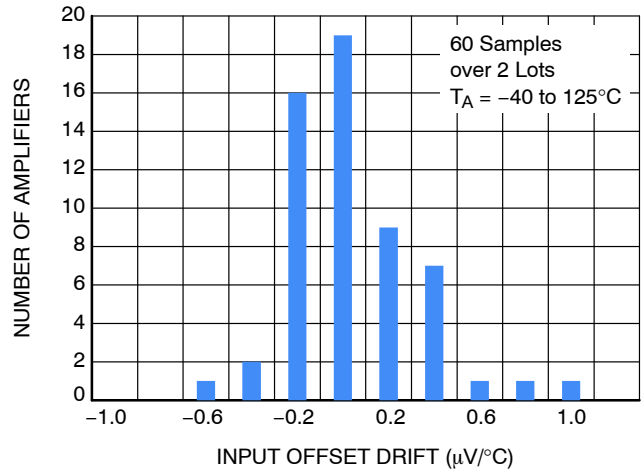

Figure 2. Input Offset Voltage Drift Distribution

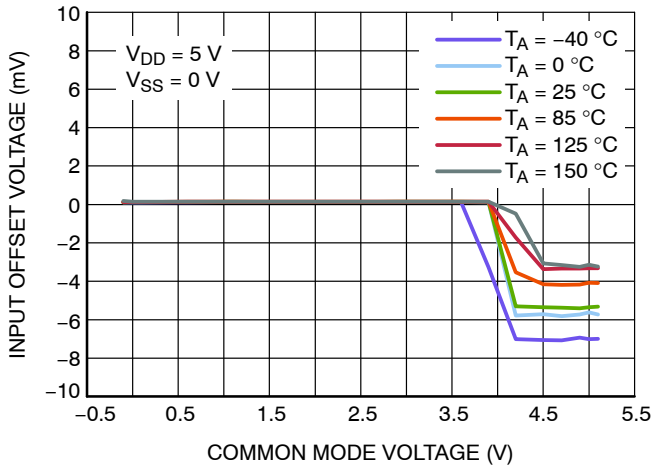

Figure 3. Input Offset Voltage vs. Common Mode Voltage

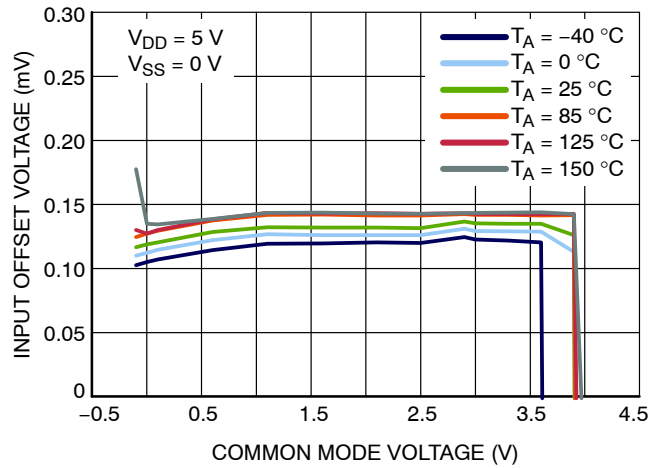

Figure 4. Input Offset Voltage vs. Common Mode Voltage, Performance Region

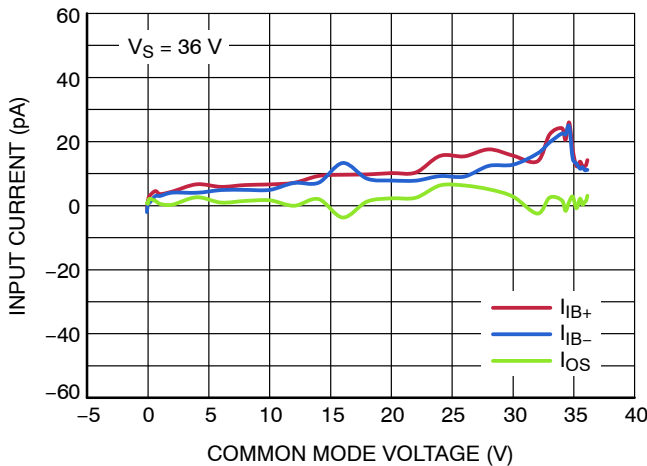

Figure 5. Input Current vs. Common Mode Voltage

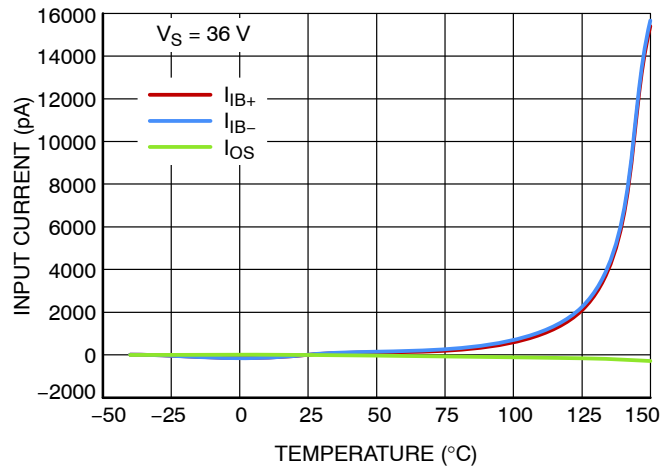

Figure 6. Input Current vs. Temperature

Typical Characteristics

Typical Performance at $T_A = 25\text{ }^\circ\text{C}$, $V_{CM} = \text{mid-supply}$, $C_L = 20\text{ pF}$, $R_L = 10\text{ k}\Omega$ to mid-supply, unless otherwise noted

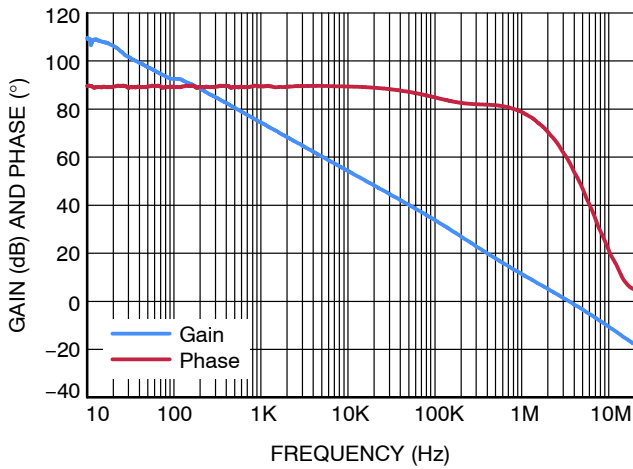

Figure 7. Open Loop Gain and Phase vs. Frequency

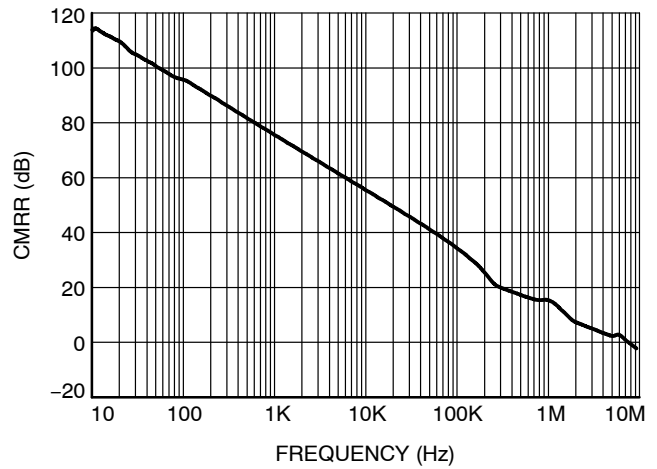

Figure 8. CMRR vs. Frequency

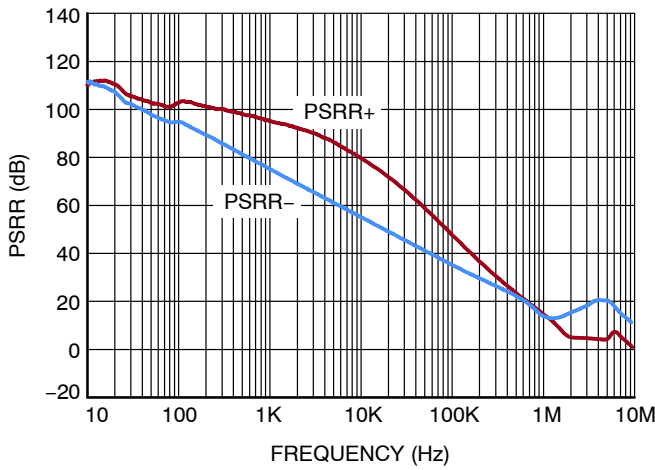

Figure 9. PSRR vs. Frequency

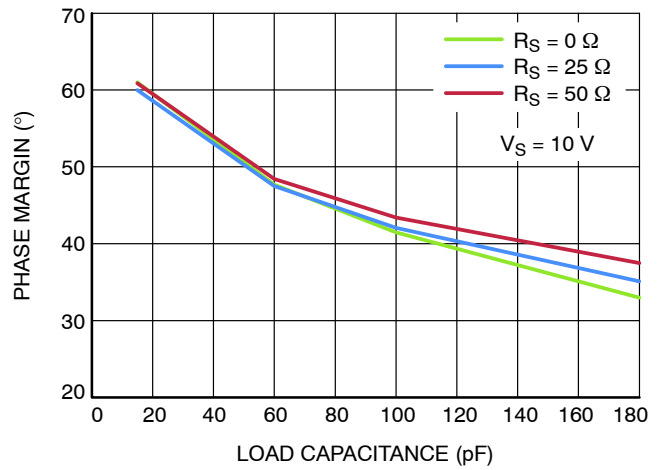

Figure 10. Phase Margin vs. Capacitive Load

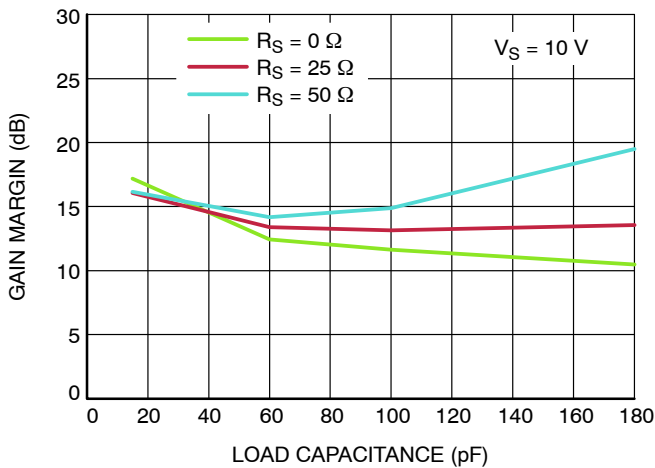

Figure 11. Gain Margin vs. Capacitive Load

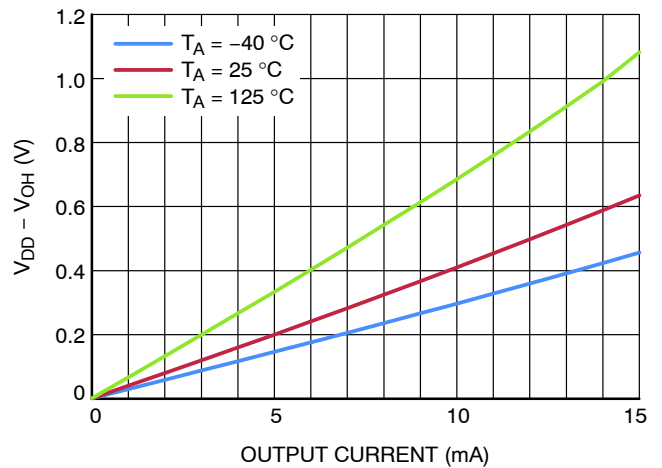

Figure 12. Output Voltage Swing High vs. Output Current at $V_S = 2.7\text{ V}$

Typical Characteristics

Typical Performance at $T_A = 25^\circ\text{C}$, $V_{CM} = \text{mid-supply}$, $C_L = 20 \text{ pF}$, $R_L = 10 \text{ k}\Omega$ to mid-supply, unless otherwise noted

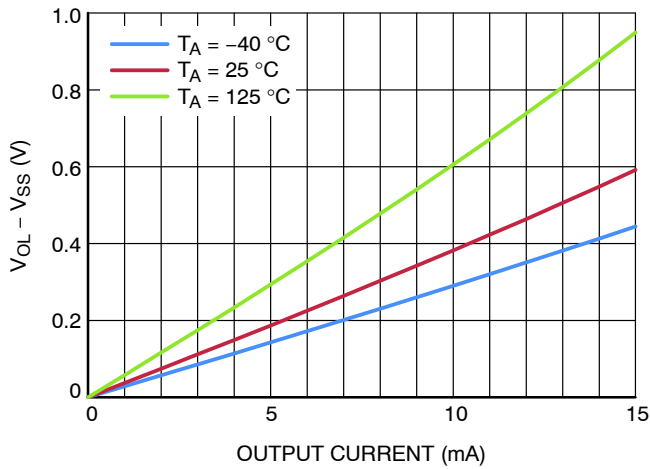

Figure 13. Output Voltage Swing vs. Output Current at $V_S = 2.7 \text{ V}$

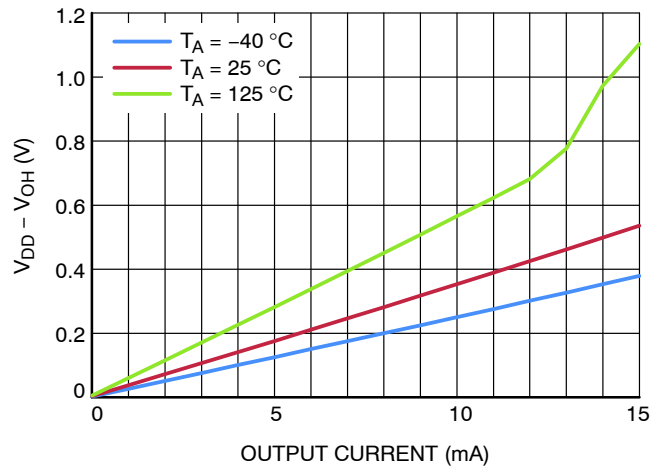

Figure 14. Output Voltage Swing vs. Output Current at $V_S = 36 \text{ V}$

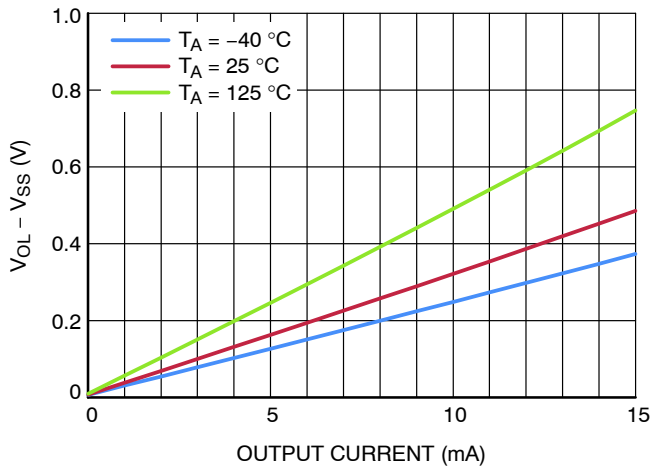

Figure 15. Output Voltage Swing vs. Output Current at $V_S = 36 \text{ V}$

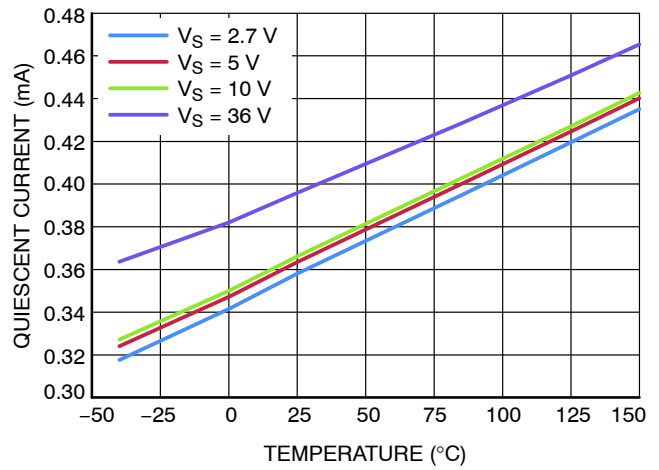

Figure 16. Quiescent Current vs. Temperature

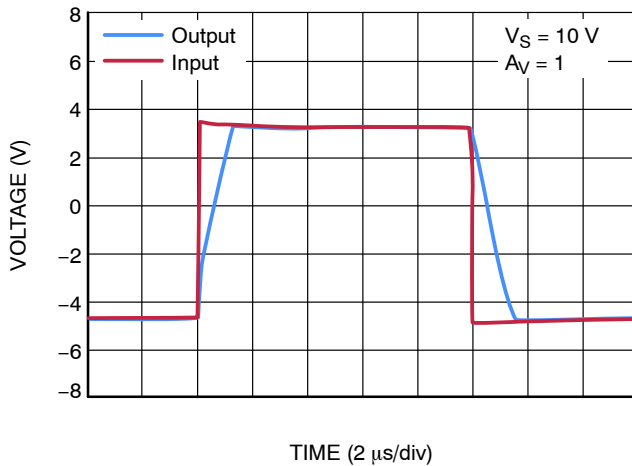

Figure 17. Large Signal Step Response

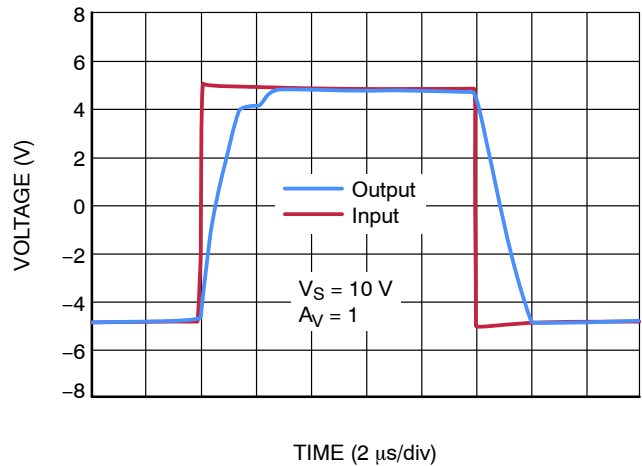
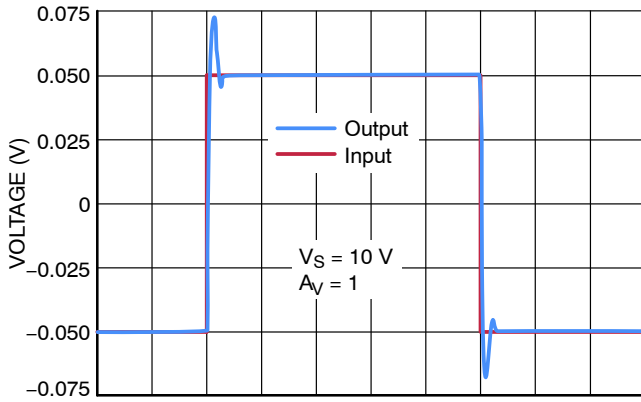

Figure 18. Large Signal Step Response

Typical Characteristics

Typical Performance at $T_A = 25\text{ }^\circ\text{C}$, $V_{CM} = \text{mid-supply}$, $C_L = 20\text{ pF}$, $R_L = 10\text{ k}\Omega$ to mid-supply, unless otherwise noted



TIME (1 $\mu\text{s}/\text{div}$)

Figure 19. Small Signal Step Response

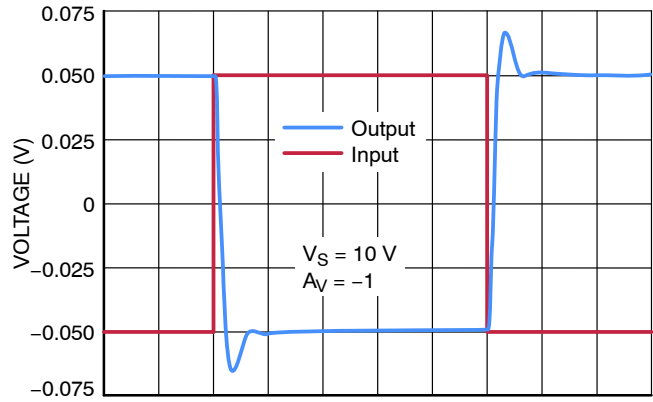

TIME (1 $\mu\text{s}/\text{div}$)

Figure 20. Small Signal Step Response

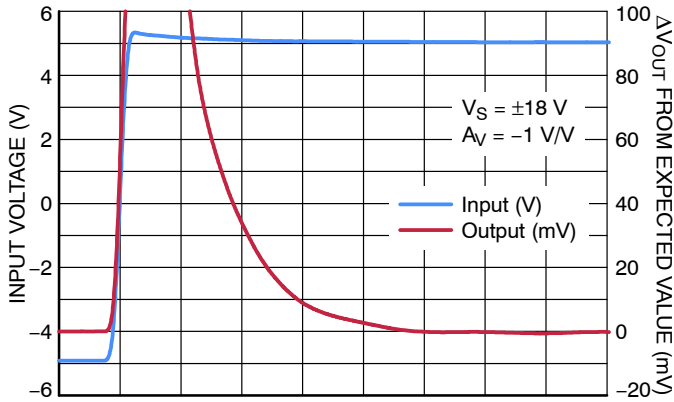

TIME (2 $\mu\text{s}/\text{div}$)

Figure 21. Settling Time

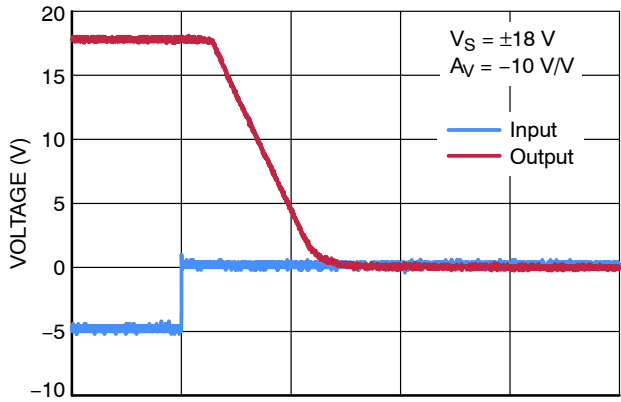

TIME (4 $\mu\text{s}/\text{div}$)

Figure 22. Output Overload Recovery Response

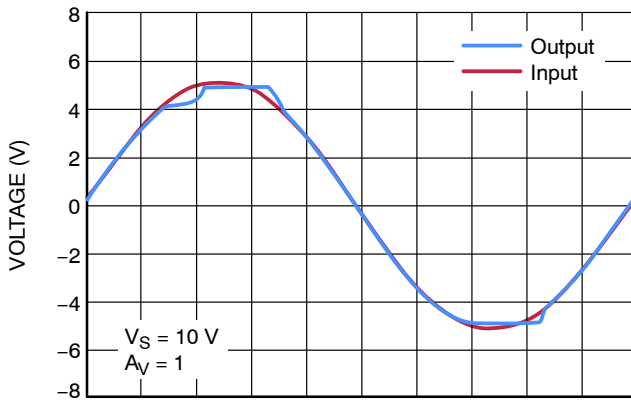

TIME (2 $\mu\text{s}/\text{div}$)

Figure 23. No Phase Reversal

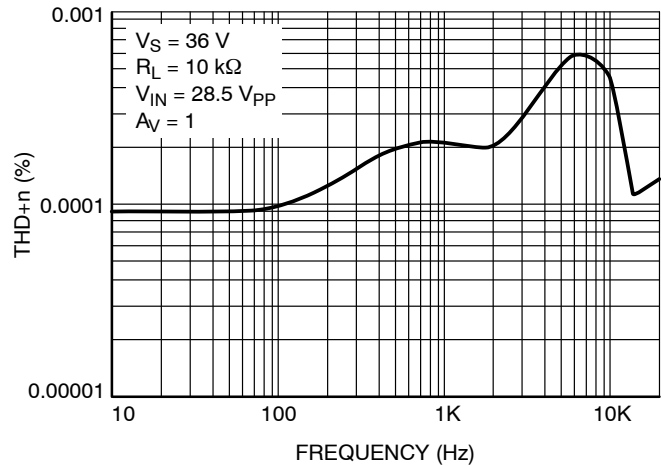

Figure 24. THD+n vs. Frequency

Typical Characteristics

Typical Performance at $T_A = 25\text{ }^\circ\text{C}$, $V_{CM} = \text{mid-supply}$, $C_L = 20\text{ pF}$, $R_L = 10\text{ k}\Omega$ to mid-supply, unless otherwise noted

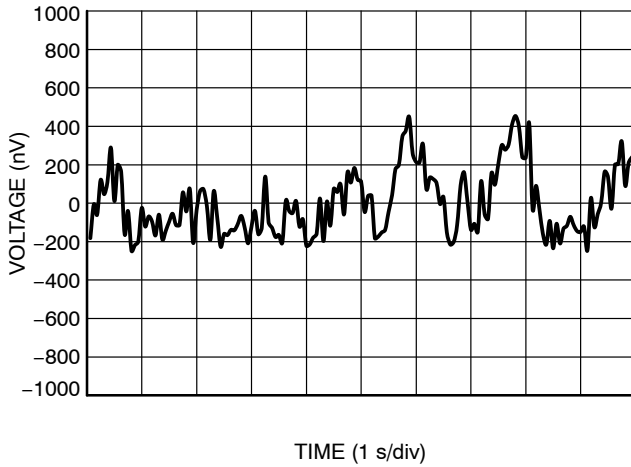

Figure 25. 0.1 Hz to 10 Hz Noise

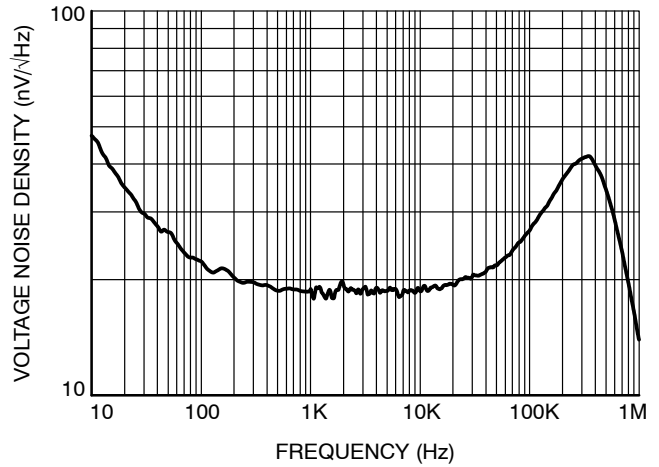

Figure 26. Voltage Noise Density vs. Frequency

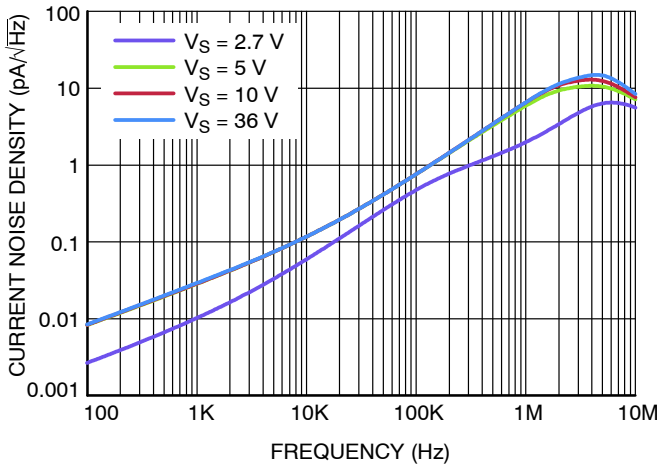

Figure 27. Current Noise Density vs. Frequency

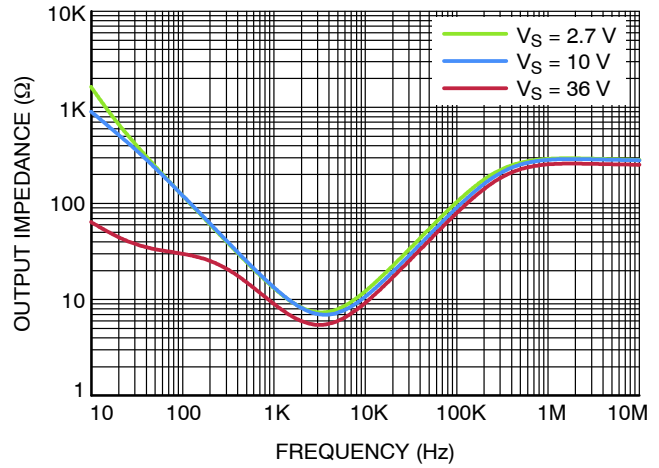

Figure 28. Open Loop Output Impedance vs. Frequency

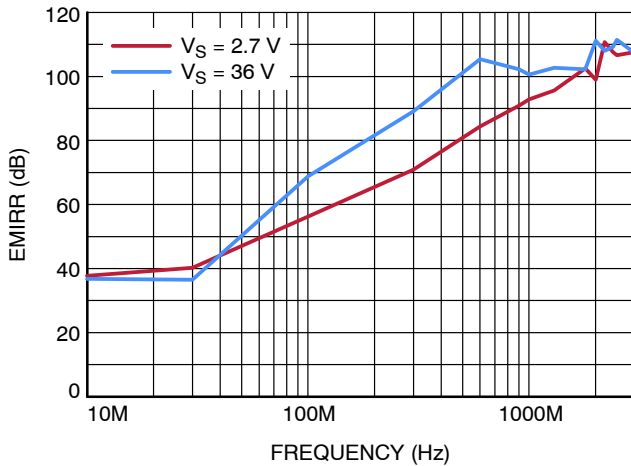

Figure 29. EMIRR vs. Frequency

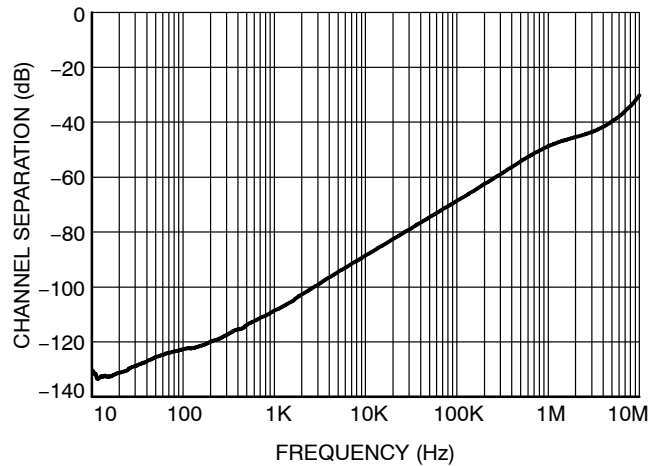

Figure 30. Channel Separation vs. Frequency

APPLICATION INFORMATION

Input and ESD Structure

The NCS20231 amplifier has back-to-back Zener diodes, which allow for normal operation with the differential voltage up to ± 5 V. Differential voltages beyond this are

permitted, up to $\pm V_S$, but increased input leakage current should be expected. Internal current limiting resistors in series with the input pins limit the current to ± 10 mA in scenarios where the differential voltage is as high as ± 36 V.

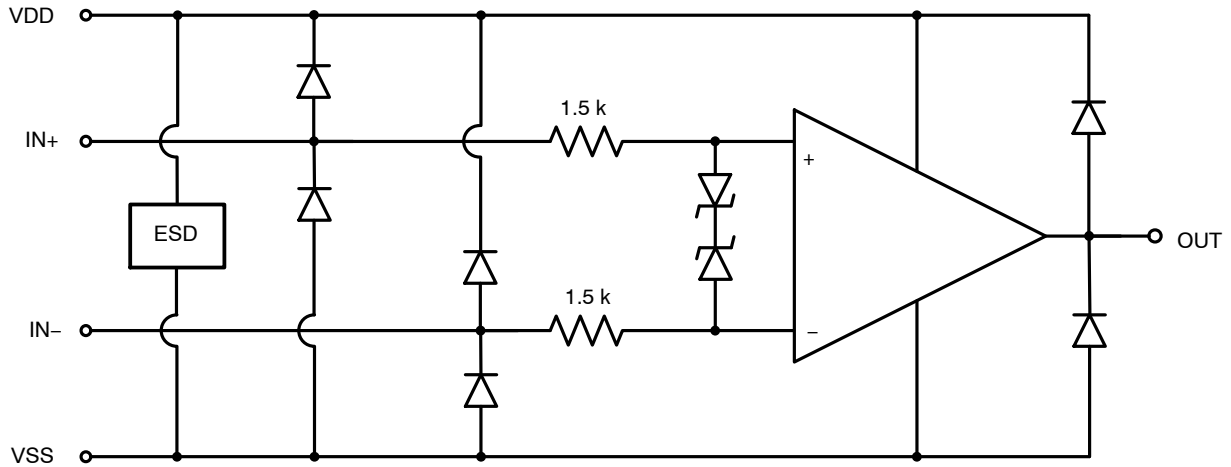

Figure 31. Representative Schematic of the Op Amp

Each input pin is diode clamped to the rails. In case of an input overvoltage, input currents must be limited to within ± 10 mA to prevent excessive current from damaging the part.

Rail-to-Rail Performance

The functional common mode input voltage spans 100 mV beyond the rails. High precision performance, as

shown throughout the ELECTRICAL CHARACTERISTICS table, is achieved in the $V_{SS} - 0.1$ V to $V_{DD} - 2$ V common mode voltage range. The input common mode extends further up to $V_{DD} + 0.1$ V to ensure functionality near the upper rail, though without precision performance in that region. The typical performance within the $V_{DD} - 2$ V to $V_{DD} + 0.1$ V range is shown in the table below.

Parameter	Symbol	Conditions	Typ	Units
Input Offset Voltage	V_{OS}	$V_{CM} = V_{DD} - 0.5$ V	± 9	mV
Input Offset Voltage over Temperature	dV_{OS}/dT		± 24	$\mu V/^{\circ}C$
Common Mode Rejection Ratio	CMRR	$V_{CM} = V_{DD} - 0.5$ V to $V_{DD} + 0.1$ V	75	dB
Open Loop Voltage Gain	A_{VOL}	$V_{CM} = V_{DD} - 0.5$ V	90	dB
Gain Bandwidth Product	GBWP	$V_{CM} = V_{DD} - 0.5$ V, $C_L = 25$ pF	2.5	MHz
Slew Rate	SR	Unity gain, $V_{CM} = V_{DD} - 1$ V to $V_{DD} - 0.2$ V	1.2	V/ μs
Voltage Noise Density	e_n	$f = 1$ kHz	1000	nV/ \sqrt{Hz}

The NCS20231 does not exhibit output phase reversal. Phase reversal occurs in some amplifiers when the input voltage exceeds the recommended input common mode voltage range, causing the output to flip to the opposite rail.

Instead, when the input common mode voltage range is exceeded on the NCS20231, the output becomes clipped at the output, limited by the output voltage swing.

NCS20231, NCV20231

ORDERING INFORMATION

Temperature	Channels	Package	Device Part Number	Marking	Shipping [†]
-------------	----------	---------	--------------------	---------	-----------------------

Industrial and Commercial

-40 °C to 125 °C	Single	TSOP-5	NCS20231SN2T1G	AAC	3000 / Tape & Reel
		SC-88	NCS20231SQ3T2G	AAG	3000 / Tape & Reel
		SOT-553	NCS20231XV53T2G	AC	4000 / Tape & Reel

Automotive Qualified, Grade 1

-40 °C to 150 °C	Single	TSOP-5	NCV20231SN2T1G	AAC	3000 / Tape & Reel
		SC-88	NCV20231SQ3T2G	AAG	3000 / Tape & Reel
		SOT-553	NCV20231XV53T2G	AC	4000 / Tape & Reel

† For information on tape and reel specifications, including part orientation and tape sizes, please refer to our Tape and Reel Packaging Specifications Brochure, [BRD8011/D](#).

* In Development. Contact local sales office for more information.

REVISION HISTORY

Revision	Description of Changes	Date
5	Revision to delete dual and quad package options.	7/3/2025
6	Revision to remove dual and quad channel references from the front page.	3/18/2026

This document has undergone updates prior to the inclusion of this revision history table. The changes tracked here only reflect updates made on the noted approval dates.



SCALE 2:1

SC-88A (SC-70-5/SOT-353)
CASE 419A-02
ISSUE M

DATE 11 APR 2023

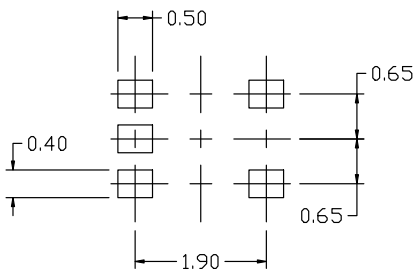
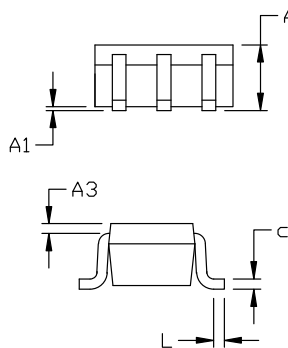

RECOMMENDED
MOUNTING FOOTPRINT

* For additional information on our Pb-Free strategy and soldering details, please download the ON Semiconductor Soldering and Mounting Techniques Reference Manual, SOLDERM/D.

NOTES:

1. DIMENSIONING AND TOLERANCING PER ANSI Y14.5M, 1982.
2. CONTROLLING DIMENSION: MILLIMETERS
3. 419A-01 OBSOLETE. NEW STANDARD 419A-02
4. DIMENSIONS D AND E1 DO NOT INCLUDE MOLD FLASH, PROTRUSIONS, OR GATE BURRS. MOLD FLASH, PROTRUSIONS, OR GATE BURRS SHALL NOT EXCEED 0.1016MM PER SIDE.

DIM	MILLIMETERS		
	MIN.	NOM.	MAX.
A	0.80	0.95	1.10
A1	---	---	0.10
A3	0.20 REF		
b	0.10	0.20	0.30
c	0.10	---	0.25
D	1.80	2.00	2.20
E	2.00	2.10	2.20
E1	1.15	1.25	1.35
e	0.65 BSC		
L	0.10	0.15	0.30

GENERIC MARKING
DIAGRAM*

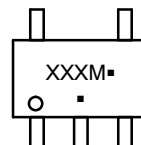

*This information is generic. Please refer to device data sheet for actual part marking. Pb-Free indicator, "G" or microdot "▪", may or may not be present. Some products may not follow the Generic Marking.

XXX = Specific Device Code
M = Date Code
▪ = Pb-Free Package

(Note: Microdot may be in either location)

STYLE 1:

- PIN 1. BASE
- 2. EMITTER
- 3. BASE
- 4. COLLECTOR
- 5. COLLECTOR

STYLE 2:

- PIN 1. ANODE
- 2. EMITTER
- 3. BASE
- 4. COLLECTOR
- 5. CATHODE

STYLE 3:

- PIN 1. ANODE 1
- 2. N/C
- 3. ANODE 2
- 4. CATHODE 2
- 5. CATHODE 1

STYLE 4:

- PIN 1. SOURCE 1
- 2. DRAIN 1/2
- 3. SOURCE 1
- 4. GATE 1
- 5. GATE 2

STYLE 5:

- PIN 1. CATHODE
- 2. COMMON ANODE
- 3. CATHODE 2
- 4. CATHODE 3
- 5. CATHODE 4

STYLE 6:

- PIN 1. EMITTER 2
- 2. BASE 2
- 3. EMITTER 1
- 4. COLLECTOR
- 5. COLLECTOR 2/BASE 1

STYLE 7:

- PIN 1. BASE
- 2. EMITTER
- 3. BASE
- 4. COLLECTOR
- 5. COLLECTOR

STYLE 8:

- PIN 1. CATHODE
- 2. COLLECTOR
- 3. N/C
- 4. BASE
- 5. EMITTER

STYLE 9:

- PIN 1. ANODE
- 2. CATHODE
- 3. ANODE
- 4. ANODE
- 5. ANODE

Note: Please refer to datasheet for style callout. If style type is not called out in the datasheet refer to the device datasheet pinout or pin assignment.

DOCUMENT NUMBER:	98ASB42984B	Electronic versions are uncontrolled except when accessed directly from the Document Repository. Printed versions are uncontrolled except when stamped "CONTROLLED COPY" in red.
DESCRIPTION:	SC-88A (SC-70-5/SOT-353)	PAGE 1 OF 1

onsemi and onsemi are trademarks of Semiconductor Components Industries, LLC dba onsemi or its subsidiaries in the United States and/or other countries. onsemi reserves the right to make changes without further notice to any products herein. onsemi makes no warranty, representation or guarantee regarding the suitability of its products for any particular purpose, nor does onsemi assume any liability arising out of the application or use of any product or circuit, and specifically disclaims any and all liability, including without limitation special, consequential or incidental damages. onsemi does not convey any license under its patent rights nor the rights of others.

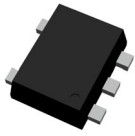

SOT-553-5 1.60x1.20x0.55, 0.50P
CASE 463B
ISSUE D

DATE 21 FEB 2024

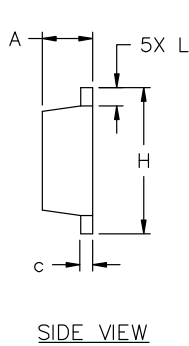
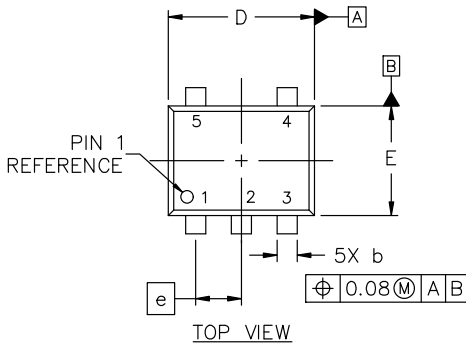

NOTES:

1. DIMENSIONING AND TOLERANCING CONFORM TO ASME Y14.5-2018.
2. ALL DIMENSIONS ARE IN MILLIMETERS.
3. MAXIMUM LEAD THICKNESS INCLUDES LEAD FINISH THICKNESS. MINIMUM LEAD THICKNESS IS THE MINIMUM THICKNESS OF BASE MATERIAL.

DIM	MILLIMETERS		
	MIN.	NOM.	MAX.
A	0.50	0.55	0.60
b	0.17	0.22	0.27
c	0.08	0.13	0.18
D	1.55	1.60	1.65
E	1.15	1.20	1.25
e	0.50 BSC		
H	1.55	1.60	1.65
L	0.10	0.20	0.30

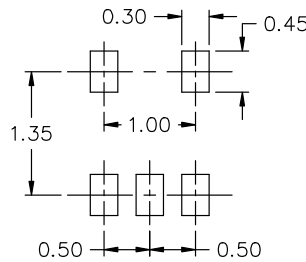

RECOMMENDED MOUNTING FOOTPRINT*

* FOR ADDITIONAL INFORMATION ON OUR Pb-FREE STRATEGY AND SOLDERING DETAILS, PLEASE DOWNLOAD THE ON SEMICONDUCTOR SOLDERING AND MOUNTING TECHNIQUES REFERENCE MANUAL, SOLDERRM/D.

GENERIC MARKING DIAGRAM*



- XX = Specific Device Code
- M = Date Code
- = Pb-Free Package

(Note: Microdot may be in either location)

*This information is generic. Please refer to device data sheet for actual part marking. Pb-Free indicator, "G" or microdot "▪", may or may not be present. Some products may not follow the Generic Marking.

STYLE 1:
PIN 1. BASE
2. EMITTER
3. BASE
4. COLLECTOR
5. COLLECTOR

STYLE 2:
PIN 1. CATHODE
2. COMMON ANODE
3. CATHODE 2
4. CATHODE 3
5. CATHODE 4

STYLE 3:
PIN 1. ANODE 1
2. N/C
3. ANODE 2
4. CATHODE 2
5. CATHODE 1

STYLE 4:
PIN 1. SOURCE 1
2. DRAIN 1/2
3. SOURCE 1
4. GATE 1
5. GATE 2

STYLE 5:
PIN 1. ANODE
2. EMITTER
3. BASE
4. COLLECTOR
5. CATHODE

STYLE 6:
PIN 1. EMITTER 2
2. BASE 2
3. EMITTER 1
4. COLLECTOR 1
5. COLLECTOR 2/BASE 1

STYLE 7:
PIN 1. BASE
2. EMITTER
3. BASE
4. COLLECTOR
5. COLLECTOR

STYLE 8:
PIN 1. CATHODE
2. COLLECTOR
3. N/C
4. BASE
5. EMITTER

STYLE 9:
PIN 1. ANODE
2. CATHODE
3. ANODE
4. ANODE
5. ANODE

DOCUMENT NUMBER:	98AON11127D	Electronic versions are uncontrolled except when accessed directly from the Document Repository. Printed versions are uncontrolled except when stamped "CONTROLLED COPY" in red.
DESCRIPTION:	SOT-553-5 1.60x1.20x0.55, 0.50P	PAGE 1 OF 1

onsemi and onSEMI are trademarks of Semiconductor Components Industries, LLC dba onsemi or its subsidiaries in the United States and/or other countries. onsemi reserves the right to make changes without further notice to any products herein. onsemi makes no warranty, representation or guarantee regarding the suitability of its products for any particular purpose, nor does onsemi assume any liability arising out of the application or use of any product or circuit, and specifically disclaims any and all liability, including without limitation special, consequential or incidental damages. onsemi does not convey any license under its patent rights nor the rights of others.

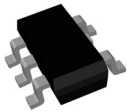

TSOP-5 3.00x1.50x0.95, 0.95P
CASE 483
ISSUE P

DATE 01 APR 2024

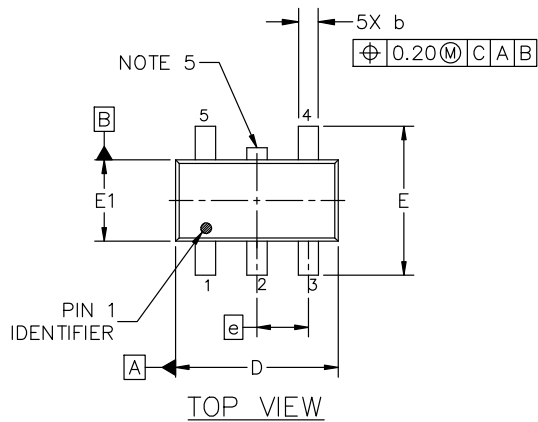

NOTES:

1. DIMENSIONING AND TOLERANCING CONFORM TO ASME Y14.5-2018.
2. ALL DIMENSION ARE IN MILLIMETERS (ANGLES IN DEGREES).
3. MAXIMUM LEAD THICKNESS INCLUDES LEAD FINISH THICKNESS. MINIMUM LEAD THICKNESS IS THE MINIMUM THICKNESS OF BASE MATERIAL.
4. DIMENSIONS D AND E1 DO NOT INCLUDE MOLD FLASH, PROTRUSIONS OF GATE BURRS. MOLD FLASH, PROTRUSIONS, OR GATE BURRS SHALL NOT EXCEED 0.15 PER SIDE. DIMENSION D.
5. OPTIONAL CONSTRUCTION: AN ADDITIONAL TRIMMED LEAD IS ALLOWED IN THIS LOCATION. TRIMMED LEAD NOT TO EXTEND MORE THAN 0.2 FROM BODY.

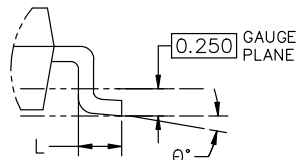
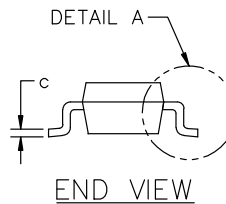
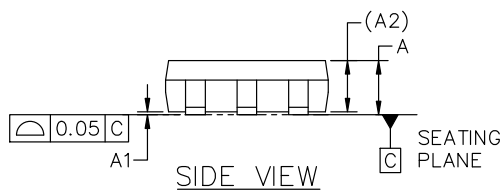

DETAIL "A"
SCALE 2:1

**GENERIC
MARKING DIAGRAM***

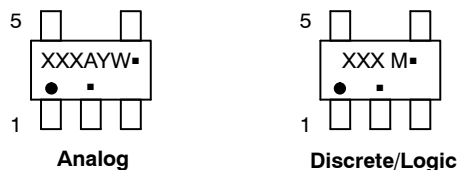

XXX = Specific Device Code XXX = Specific Device Code
A = Assembly Location M = Date Code
Y = Year ▪ = Pb-Free Package
W = Work Week

▪ = Pb-Free Package

(Note: Microdot may be in either location)

*This information is generic. Please refer to device data sheet for actual part marking. Pb-Free indicator, "G" or microdot "▪", may or may not be present. Some products may not follow the Generic Marking.

DIM	MILLIMETERS		
	MIN.	NOM.	MAX.
A	0.900	1.000	1.100
A1	0.010	0.055	0.100
A2	0.950 REF.		
b	0.250	0.375	0.500
c	0.100	0.180	0.260
D	2.850	3.000	3.150
E	2.500	2.750	3.000
E1	1.350	1.500	1.650
e	0.950 BSC		
L	0.200	0.400	0.600
θ	0°	5°	10°

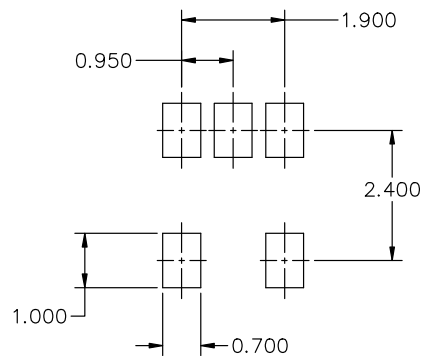

RECOMMENDED MOUNTING FOOTPRINT*

* FOR ADDITIONAL INFORMATION ON OUR Pb-FREE STRATEGY AND SOLDERING DETAILS, PLEASE DOWNLOAD THE ON SEMICONDUCTOR SOLDERING AND MOUNTING TECHNIQUES REFERENCE MANUAL, SOLDERM/D.

DOCUMENT NUMBER:	98ARB18753C	Electronic versions are uncontrolled except when accessed directly from the Document Repository. Printed versions are uncontrolled except when stamped "CONTROLLED COPY" in red.
DESCRIPTION:	TSOP-5 3.00x1.50x0.95, 0.95P	PAGE 1 OF 1

onsemi and onsemi are trademarks of Semiconductor Components Industries, LLC dba onsemi or its subsidiaries in the United States and/or other countries. onsemi reserves the right to make changes without further notice to any products herein. onsemi makes no warranty, representation or guarantee regarding the suitability of its products for any particular purpose, nor does onsemi assume any liability arising out of the application or use of any product or circuit, and specifically disclaims any and all liability, including without limitation special, consequential or incidental damages. onsemi does not convey any license under its patent rights nor the rights of others.

onsemi, **Onsemi**, and other names, marks, and brands are registered and/or common law trademarks of Semiconductor Components Industries, LLC dba "**onsemi**" or its affiliates and/or subsidiaries in the United States and/or other countries. **onsemi** owns the rights to a number of patents, trademarks, copyrights, trade secrets, and other intellectual property. A listing of **onsemi**'s product/patent coverage may be accessed at www.onsemi.com/site/pdf/Patent-Marking.pdf. **onsemi** reserves the right to make changes at any time to any products or information herein, without notice. The information herein is provided "as-is" and **onsemi** makes no warranty, representation or guarantee regarding the accuracy of the information, product features, availability, functionality, or suitability of its products for any particular purpose, nor does **onsemi** assume any liability arising out of the application or use of any product or circuit, and specifically disclaims any and all liability, including without limitation special, consequential or incidental damages. Buyer is responsible for its products and applications using **onsemi** products, including compliance with all laws, regulations and safety requirements or standards, regardless of any support or applications information provided by **onsemi**. "Typical" parameters which may be provided in **onsemi** data sheets and/or specifications can and do vary in different applications and actual performance may vary over time. All operating parameters, including "Typicals" must be validated for each customer application by customer's technical experts. **onsemi** does not convey any license under any of its intellectual property rights nor the rights of others. **onsemi** products are not designed, intended, or authorized for use as a critical component in life support systems or any FDA Class 3 medical devices or medical devices with a same or similar classification in a foreign jurisdiction or any devices intended for implantation in the human body. Should Buyer purchase or use **onsemi** products for any such unintended or unauthorized application, Buyer shall indemnify and hold **onsemi** and its officers, employees, subsidiaries, affiliates, and distributors harmless against all claims, costs, damages, and expenses, and reasonable attorney fees arising out of, directly or indirectly, any claim of personal injury or death associated with such unintended or unauthorized use, even if such claim alleges that **onsemi** was negligent regarding the design or manufacture of the part. **onsemi** is an Equal Opportunity/Affirmative Action Employer. This literature is subject to all applicable copyright laws and is not for resale in any manner.

ADDITIONAL INFORMATION

TECHNICAL PUBLICATIONS:

Technical Library: www.onsemi.com/design/resources/technical-documentation
onsemi Website: www.onsemi.com

ONLINE SUPPORT: www.onsemi.com/support

For additional information, please contact your local Sales Representative at www.onsemi.com/support/sales