

Advanced Synchronous Rectifier Controller for LLC Resonant Converter

NCP4318

NCP4318 is an advanced synchronous rectification (SR) controller for LLC resonant converter with minimum external components. It has two gate drivers for driving the SR MOSFETs rectifying the outputs of the secondary transformer windings. The two gate drivers have their own drain and source sensing pins and operate independently of each other. The advanced adaptive dead time control compensates the voltage across parasitic inductance to minimize the body diode conduction and maximize the system efficiency. The advanced turn-off control algorithm allows stable SR operation over entire load range. NCP4318 has two versions of pin assignment – NCP4318A, NCP4318B, and two types of package – SOIC-8 and SOIC-8 EP.

Features

- Mixed Mode SR Turn-off Control
- Anti Shoot-through Control for Reliable SR Operation
- 200 V-rated Drain Sensing and Dedicated Source Sensing Pins
- Advanced Adaptive Dead Time Control
- SR Current Inversion Detection
- Adaptive Minimum Turn-on Time for Noise Immunity
- SR Conduction Time Increase Rate Limitation
- Multi-level Turn-off Threshold Voltage
- Adaptive Gate Voltage (10 V, 6 V)
- Low Operating Current (100 μ A) in Green Mode
- Soft Start with 0 V / 6 V Gate Output Voltage
- Short Turn-on and Turn-off Delay Time (30 ns / 30 ns)
- High Gate Sourcing and Sinking Current (1.5 A / 4.5 A)
- Wide Operating Supply Voltage Range from 6.5 V to 35 V
- Wide Operating Frequency Range (22 kHz to 500 kHz)
- SOIC-8 and SOIC-8 EP Packages
- These Devices are Pb-Free and are RoHS Compliant

Applications

- High Power Density Adapters
- Large Screen LED-TV and OLED-TV Power Supplies
- High Efficiency Desktop and Server Power Supplies
- Networking and Telecom Power Supplies
- High Power LED Lighting



MARKING DIAGRAM

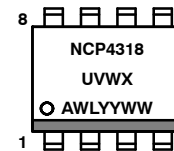

U = Pin Layout, A and B
 V = Frequency, H: High, L: Low
 WX = Additional IPT Option
 A = Assembly Location
 WL = Wafer Lot Traceability
 YYWW = Date Code

PIN CONNECTIONS

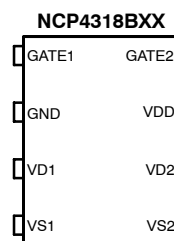
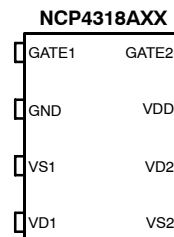

(Top View)

ORDERING INFORMATION

See detailed ordering, marking and shipping information on page 3 of this data sheet.

NCP4318

PIN DESCRIPTION

Pin Number		Name	Description
NCP4318A	NCP4318B		
1	1	GATE1	Gate drive output for SR MOSFET1
2	2	GND	Ground
3	4	VS1	Synchronous rectifier source sense input for SR1
4	3	VD1	Synchronous rectifier drain sense input. $I_{OFFSET1}$ current source flows out of the VD1 pin such that an external series resistor can be used to adjust the synchronous rectifier turn-off threshold. The $I_{OFFSET1}$ current source is turned off when V_{DD} is under-voltage or when switching is disabled in green mode
5	5	VS2	Synchronous rectifier source sense input for SR2
6	6	VD2	Synchronous rectifier drain sense input. $I_{OFFSET2}$ current source flows out of the VD2 pin such that an external series resistor can be used to adjust the synchronous rectifier turn-off threshold. The $I_{OFFSET2}$ current source is turned off when V_{DD} is under-voltage or when switching is disabled in green mode
7	7	VDD	Supply Voltage
8	8	GATE2	Gate drive output for SR MOSFET2
Exposed pad*		EP	EP is floating from electrical connection to the chip. We recommend connecting it to GND or keeping it floating.

* Exposed pad applies to parts with SOIC-8 EP package. SOIC-8 package options do not have this pin.

ORDERING INFORMATION

Ordering Code	Device Marking	Package	Shipping [†]
NCP4318AHDDR2G	NCP4318AHD	SOIC-8 (Pb-Free)	2500 / Tape & Reel
NCP4318AHJDR2G	NCP4318AHJ		
NCP4318ALCDR2G	NCP4318ALC		
NCP4318ALKDR2G	NCP4318ALK		
NCP4318ALLDR2G	NCP4318ALL		
NCP4318ALSDR2G	NCP4318ALS		
NCP4318BLCDR2G	NCP4318BLC		
NCP4318ALFPDR2G	NCP4318ALFP	SOIC-8 EP (Pb-Free)	
NCP4318ALGPDR2G	NCP4318ALGP		

[†] For information on tape and reel specifications, including part orientation and tape sizes, please refer to our Tape and Reel Packaging Specifications Brochure, [BRD8011/D](#).

NCP4318

MAXIMUM RATINGS

Symbol	Rating	Value	Unit	
V_{DD}	Power Supply Input Pin Voltage	-0.3 to 37	V	
V_{D1}, V_{D2}	Drain Sense Input Pin Voltage	-4 to 200	V	
V_{GATE1}, V_{GATE2}	Gate Drive Output Pin Voltage	-0.3 to 17	V	
V_{S1}, V_{S2}	Source Sense Input Pin Voltage	-0.3 to 5.5	V	
V_{S1-DYN}, V_{S2-DYN}	Source Sense Input Pin Dynamic Voltage (Pulse Width = 200 ns)	-4 to 5.5	V	
P_D	Power Dissipation ($T_A = 25\text{ }^\circ\text{C}$) SOIC-8 SOIC-8 EP (Note 3)	0.625 3.7	W	
T_J	Maximum Junction Temperature	-40 to 150	$^\circ\text{C}$	
T_{STG}	Storage Temperature Range	-60 to 150	$^\circ\text{C}$	
T_L	Lead Temperature (Soldering, 10 Seconds)	260	$^\circ\text{C}$	
ESD	Electrostatic Discharge Capability	Human Body Model, ANSI / ESDA / JEDEC JS-001-2012 (except VD1, VD2 pin)	3	kV
		Human Body Model, VD1-GND, VD2-GND pin to pin with 330-pF (Note 2) ca- pacitance on VD1 and VD2 pin	2	
		Charged Device Model, JESD22-C101	1	

Stresses exceeding those listed in the Maximum Ratings table may damage the device. If any of these limits are exceeded, device functionality should not be assumed, damage may occur and reliability may be affected.

1. All voltage values are with respect to the GND pin.
2. The capacitance can be replaced by C_{OSS} of MOSFET.
3. Same test condition as in Note 5.

THERMAL CHARACTERISTICS

Symbol	Rating	Value	Unit
$R_{\theta JA}$	Thermal Resistance, Junction-to-Ambient. SOIC-8 (Note 4) SOIC-8 EP (Note 5)	165 27	$^\circ\text{C}/\text{W}$
$R_{\psi JT}$	Thermal Characterization Parameter between Junction and the Center of the Top of the Package. SOIC-8 (Note 4) SOIC-8 EP (Note 5)	22 3	$^\circ\text{C}/\text{W}$

4. JEDEC standard: JESD51-2 (still air natural convection) and JESD51-3 (1s0p).
5. JEDEC standard: JESD51-2 (still air natural convection) and JESD51-7 (2s2p) with four 0.2-mm-in-diameter Cu-plated thermal vias under the exposed pad. The vias connect to all buried planes and a bottom-side trace of the test board.

RECOMMENDED OPERATING CONDITIONS

Symbol	Rating	Min	Max	Unit
V_{DD}	VDD Pin Supply Voltage to GND (Note 6)	0	35	V
V_{D1}, V_{D2}	Drain Sense Input Pin Voltage	-0.7	180	V
V_{S1}, V_{S2}	Source Sense Input Pin Voltage	-0.3	5	V
T_J	Operating Junction Temperature	-40	+125	$^\circ\text{C}$

Functional operation above the stresses listed in the Recommended Operating Ranges is not implied. Extended exposure to stresses beyond the Recommended Operating Ranges limits may affect device reliability.

6. Allowable operating supply voltage V_{DD} can be limited by the power dissipation of NCP4318 related to switching frequency, load capacitance and ambient temperature.

NCP4318

ELECTRICAL CHARACTERISTICS

($V_{DD} = 12\text{ V}$ and $T_J = -40\text{ }^\circ\text{C}$ to $125\text{ }^\circ\text{C}$ unless otherwise specified.)

Symbol	Parameter	Test Conditions	Min	Typ	Max	Unit
SUPPLY VOLTAGE AND CURRENT SECTION						
V_{DD-ON}	Turn-on Threshold	V_{DD} rising with 4.3 V / 1 ms		4.0	4.3	V
V_{DD-OFF}	Turn-off Threshold	$V_{DD} < V_{DD-OFF}$	3.6	3.8		V
$V_{DD-GATE-ON}$	SR Gate Enable Threshold Voltage	$V_{DD} > V_{DD-GATE-ON}$		6.5	7.1	V
$V_{DD-GATE-OFF}$	SR Gate Disable Threshold Voltage (Note 7)	$V_{DD} < V_{DD-GATE-OFF}$	5.0	6.0		V
I_{DD-OP1}	Operating Current	$f_{SW} = 100\text{ kHz}$, $C_{GATE} = 1\text{ nF}$		8	10	mA
I_{DD-OP0}	Operating Current	$f_{SW} = 100\text{ kHz}$, $C_{GATE} = 0\text{ nF}$			6	mA
$I_{DD-START}$	Start-up Current	$V_{DD} = V_{DD-ON} - 0.1\text{ V}$			100	μA
$I_{DD-GREEN}$	Operating Current in Green Mode	$V_{DD} = 12\text{ V}$ (no $V_{D1/2}$ switching) GREEN1 enable at $T_J = 25\text{ }^\circ\text{C}$ Excluding ALFP and ALGP		100	210	μA
$\eta_{SS-SKIP}$	Number of $V_{D1/2}$ Alternative Switching for Soft Start Skipping	$V_{D1/2}$ falling lower than V_{TH-ON} & $V_{D1/2}$ rising higher than V_{TH-HGH} & No GATE output at $f_{SW} = 200\text{ kHz}$, $C_{GATE} = 0\text{ nF}$		255		Cycle

DRAIN VOLTAGE SENSING SECTION

V_{OSI}	Comparator Input Offset Voltage (Note 7)		-1	0	1	mV
$I_{DRAIN-LKG}$	Drain Pin Leakage Current	$V_{D1/2} = 200\text{ V}$			1	μA
V_{TH-ON}	Turn-on Threshold (Note 7)	$R_{OFFSET} = 0\ \Omega$ (includes comparator input offset voltage)		-100		mV
$t_{OFF-MIN}$	Minimum Off-time	From $V_{D1/2}$ higher than V_{TH-HGH} in ALS in AHD, AHJ in ALC, ALK, ALL, BLC, ALFP, ALGP	450 750 1400	800 1150 2000	1150 1550 2800	ns
t_{ON-DLY}	Turn-on Propagation Delay	Turn-on comparator delay From $V_{D1/2} = -0.2$ to $V_{GATE} = 1\text{ V}$, when $DLY_EN = 0$		30	80	ns
$t_{ON-DLY2}$	Turn-on De-bounce Time When Additional Turn-on Delay is Enabled (Notes 7)	Turn-on comparator delay From $V_{D1/2} = -0.2$ to $V_{GATE} = 1\text{ V}$, when $DLY_EN = 1$. in AHD, AHJ, ALC, ALK, ALL, ALS, BLC, ALFP, ALGP		240		ns
$t_{OFF-DLY}$	Turn-off Propagation Delay	Turn-off comparator delay From $V_{D1/2} = 0.6$ to $V_{GATE} = 5.7\text{ V}$		30	80	ns
$V_{TH-OFF-MIN}$	Minimum Turn-off Threshold Voltage (Notes 7, 8)	$R_{OFFSET} = 0\ \Omega$ (includes comparator input offset voltage) in ALC, ALK, ALL, ALS, BLC in AHD, AHJ, ALFP, ALGP		-6 -14		mV
$V_{TH-OFF-STEP}$	Step Size of Adaptive Turn-off Threshold Voltage (Note 7, 8)	$R_{OFFSET} = 0\ \Omega$ in AHD, AHJ, ALC, BLC, ALL, ALFP, ALGP in ALK, ALS		4 8		mV
$V_{TH-OFF-MAX}$	Maximum Turn-off Threshold Voltage (Notes 7, 8)	$R_{OFFSET} = 0\ \Omega$, in ALC, BLC, ALL in ALK, ALS in AHD, AHJ, ALFP, ALGP		118 242 110		mV
$V_{TH-OFF-RST}$	Reset Value of Turn-off Threshold Voltage (Note 7)	$R_{OFFSET} = 0\ \Omega$, in ALC, BLC, ALL in ALK, ALS in ALFP in AHJ, ALGP		2 10 -6 -10		mV

NCP4318

ELECTRICAL CHARACTERISTICS (continued)

($V_{DD} = 12\text{ V}$ and $T_J = -40\text{ }^\circ\text{C}$ to $125\text{ }^\circ\text{C}$ unless otherwise specified.)

Symbol	Parameter	Test Conditions	Min	Typ	Max	Unit
DRAIN VOLTAGE SENSING SECTION						
$K_{2ND-VOFF}$	Ratio of Second-step V_{TH-OFF} to V_{TH-OFF} (Note 7)	LLD = 0. If LLD ≥ 1 , 2 nd step $V_{TH-OFF} = V_{TH-OFF}$		60		%
$K_{2ND-TOFF}$	Effective On-time Duration Ratio to On-time of Last Switching Cycle for the Second Step V_{TH-OFF} (Note 7)	LLD = 0, $t_{VG1(n-1)} = 8\text{ }\mu\text{s}$, and $K_{2ND-TOFF} * t_{VG1(n-1)} > t_{MIN-ON}$. If $K_{2ND-TOFF} * t_{VG1(n-1)} < t_{MIN-ON}$, $t_{VG1-70} = t_{MIN-ON}$		70		%
V_{TH-HGH}	Drain Voltage High Detect Threshold Voltage (Note 7)	$V_{D1/2}$ rising in AHD, AHJ, ALC, ALK, ALL, BLC, ALFP, ALGP in ALS		0.85 1.5		V
$t_{GATE-SKIP1}$	Minimum SR Conduction Time to Enable SR when DLY_EN = 0 (3 steps $V_{TH-OFF1}$ or 2 Decrease when Gate Skip is Triggered)	The duration from turn-on trigger to $V_{D1/2}$ rising higher than V_{TH-HGH} , when DLY_EN = 0 in AHD, AHJ in ALC, ALK, ALL, ALS, BLC, ALFP, ALGP	350 500	550 710		ns
$t_{GATE-SKIP2}$	Minimum SR Conduction Time to Enable SR when DLY_EN = 1 (3 steps $V_{TH-OFF1}$ or 2 Decrease when Gate Skip is Triggered) (Note 7)	The duration from turn-on trigger to $V_{D1/2}$ rising higher than V_{TH-HGH} , when DLY_EN = 1 in AHD, AHJ in ALC, ALK, ALL, ALS, BLC, ALFP, ALGP		385 510		ns
MINIMUM ON-TIME AND MAXIMUM ON-TIME SECTION						
K_{TON1}	Adaptive Minimum On Time Ratio when DLY_EN = 0	DLY_EN = 0 & $t_{SRCOND(n-1)} = 8\text{ }\mu\text{s}$ $t_{MIN-ON} = K_{TON1} * t_{SRCOND(n-1)}$ in ALFP, ALGP in ALC, ALK, ALL, ALS, AHD, AHJ, BLC	29 43	34 50	39 57	%
K_{TON2}	Adaptive Minimum On Time Ratio when DLY_EN = 1	DLY_EN = 1 & $t_{SRCOND(n-1)} = 8\text{ }\mu\text{s}$ $t_{MIN-ON} = K_{TON2} * t_{SRCOND(n-1)}$ in ALFP, ALGP in ALC, ALK, ALL, ALS, AHD, AHJ, BLC		17 20		%
$t_{MIN-ON-U1}$	Upper Limit of Minimum On-time when DLY_EN = 0	$200\text{ ns} < t_{MIN-ON} < t_{MIN-ON-U1}$, DLY_EN = 0	4	5	6	μs
$t_{MIN-ON-U2}$	Upper Limit of Minimum On-time when DLY_EN = 1	$200\text{ ns} < t_{MIN-ON} < t_{MIN-ON-U2}$, DLY_EN = 1	2	2.5	3	μs
K_{INV1}	SR Current Inversion Detection Window Ratio when DLY_EN = 0	DLY_EN = 0		= K_{TON1}		%
K_{INV2}	SR Current Inversion Detection Window Ratio when DLY_EN = 1	DLY_EN = 1		= K_{TON2}		%
$\eta_{INV-EXT}$	Consecutive Normal Switching Cycles to Exit SR Current Inversion State DLY_EN = 1 (Note 7)	Without parasitic $V_{D1/2}$ oscillation		16k		cycle
$t_{SR-MAX-ON}$	Maximum SR Turn-on Time (Note 7)	in none in ALC, ALK, ALS, AHD, AHJ, BLC, ALFP, ALGP	21	30 Inf.	39	μs
f_{MIN}	Minimum Switching Frequency (Note 7)	$1/(t_{SR-MAX-ON-CH1} + t_{SR-MAX-ON-CH2})$ in none in ALC, ALK, ALL, ALS, AHD, AHJ, BLC, ALFP, ALGP			22 0	kHz
DEAD TIME REGULATION SECTION						
I_{OFFSET}	Maximum of Adaptive Offset Current which have 31 Steps and $10\text{ }\mu\text{A}$ of Resolution (Note 8)	$V_{D1} = V_{D2} = 0$ in all except ALFP in ALFP	285	310 0	335	μA

NCP4318

ELECTRICAL CHARACTERISTICS (continued)

($V_{DD} = 12\text{ V}$ and $T_J = -40\text{ }^\circ\text{C}$ to $125\text{ }^\circ\text{C}$ unless otherwise specified.)

Symbol	Parameter	Test Conditions	Min	Typ	Max	Unit
DEAD TIME REGULATION SECTION						
$t_{DEAD-LBAND}$	Lower Band of Dead Time Regulation (Notes 7, 8)	From V_{GATE} falling below $V_{GATE-LOW}$ in ALC, ALK, ALL, ALS, BLC, ALFP, ALGP in AHD, AHJ		90 170		ns
$t_{DEAD-HBAND}$	Upper Band of Dead Time Regulation (Notes 7, 8)	From V_{GATE} falling below $V_{GATE-LOW}$, when LLD = 0		$t_{DEAD-LBAND} + 90$		ns
η_{LLD1}	First Light Load Detection (LLD1) Step Number based on V_{TH-OFF} Modulator (Note 7)	$\eta V_{TH-OFF-CNT} \leq \eta_{LLD1}$		7		
η_{LLD2}	Second Light Load Detection (LLD2) Step Number based on V_{TH-OFF} Modulator (Note 7)	$\eta V_{TH-OFF-CNT} \leq \eta_{LLD2}$		3		
GREEN MODE SECTION						
$t_{GRN1-ENT}$	Non-switching Period of SR Gate to Enter Green Mode	When SRCOND1, 2 are both low for $t_{GRN1-ENT}$, GREEN1 = HIGH. in ALC, ALK, ALL, ALS, BLC in AHD, AHJ	45 25	60 40	75 55	μs
$t_{GRN2-ENT}$	Non-switching Period of SR Gate to Reset V_{TH-OFF} and Set DLY_EN	When SRCOND1, 2 are both low for $t_{GRN2-ENT}$, generate GREEN2 pulse. in ALC, ALK, ALL, ALS, BLC, ALFP, ALGP in AHD, AHJ	4.5 2.5	6 4	7.5 5.5	μs
$\eta_{CSW-EXT}$	Number of Buffer Switching Cycle to Recover I_{DD-OP} when IC Exits from Green mode.	Number of switching with $V_{D1} > V_{TH-HGH}$ to exit GREEN1. Excluding ALFP and ALGP		4		cycle
PROTECTION SECTION						
V_{SRCINV}	Threshold Voltage of Current Inversion Detection (Note 7)	LLD = 0 LLD \geq 1, Virtual V_{TH-OFF}		0 V_{TH-OFF}		mV
t_{INV}	Debounce Time of SR Current Inversion Detection (Note 7)	$V_{GATE1/2} > 4.5\text{ V}$ & $V_{D1/2} > V_{SRCINV}$ for t_{INV} in AHD, AHJ, ALFP, ALGP in ALC, ALK, ALL, BLC in ALS		170 320 520		ns
V_{SD-PRI}	Drain Threshold Voltage for Primary Shutdown Protection (Note 7)	$V_{GATE1/2} > 4.5\text{ V}$ with 200 ns delay & $V_{D1/2} > V_{SD-PRI}$ when DLY_EN = 0. $V_{GATE1/2} > 4.5\text{ V}$ with 100 ns delay & $V_{D1/2} > V_{SD-PRI}$ when DLY_EN = 1. in AHD, AHJ in ALC, ALK, BLC, ALFP, ALGP in ALS in ALL		100 150 200 500		mV
K_{SD-PRI}	Detection Window Time Ratio based on $t_{VG1}(n-1)$ for the Primary Shutdown Protection (Note 7)	LLD = 0, $t_{VG1}(n-1) = 8\text{ }\mu\text{s}$, and $K_{2ND-TOFF} * t_{VG1}(n-1) > t_{MIN-ON}$. If $K_{2ND-TOFF} * t_{VG1}(n-1) < t_{MIN-ON}$, $t_{VG1-70} = t_{MIN-ON}$.	65	70	75	%
V_{ABN-VD}	Drain Threshold Voltage to Trigger Abnormal VD Sensing Protection (Note 7)	$V_{D1/2} > V_{ABN-VD}$ & $V_{GATE1/2} > 4.5\text{ V}$ with 100 ns delay within K_{SD-PRI} . $V_{ABN-VD} = V_{TH-HGH}$ in AHD, AHJ, ALC, ALK, ALL, BLC, ALFP, ALGP in ALS		0.85 1.5		V
T_{OTP1}	Over Temperature Protection Reducing V_{GATE} (Note 7)	$T_J > T_{OTP1}$ & $V_{GATE} = 6.7\text{ V}$ in AHJ, ALC, BLC in AHD, ALK, ALL, ALS, ALFP, ALGP		105 130		$^\circ\text{C}$

NCP4318

ELECTRICAL CHARACTERISTICS (continued)

($V_{DD} = 12\text{ V}$ and $T_J = -40\text{ }^{\circ}\text{C}$ to $125\text{ }^{\circ}\text{C}$ unless otherwise specified.)

Symbol	Parameter	Test Conditions	Min	Typ	Max	Unit
--------	-----------	-----------------	-----	-----	-----	------

PROTECTION SECTION

T_{OTP2}	Over Temperature Protection Stopping Gate Operation (Note 7)	$T_J > T_{OTP2}$ & No gate output in AHJ, ALC, BLC in AHD, ALK, ALL, ALS, ALFP, ALGP		140 Disable		$^{\circ}\text{C}$
$T_{OTP-RST}$	Reset Level of Over Temperature Protection (Note 7)	$T_J < T_{OTP-RST}$, OTP1 and OTP2 are reset		80		$^{\circ}\text{C}$

GATE DRIVER SECTION

$V_{GATE-MAX}$	Gate Clamping Voltage (Note 7)	$12\text{ V} < V_{DD} < 33\text{ V}$, $C_{GATE} = 4.7\text{ nF}$ at $T_J < T_{OTP1}$	9	10.5	12	V
$V_{GATE-MAX-6V}$	Gate Clamping Voltage for Adaptive Gate Voltage Control (Note 7)	$V_{DD} = 12\text{ V}$, $C_{GATE} = 4.7\text{ nF}$ in ALC, BLC	5.0	6.7	8.2	V
t_{HFS-EN}	Adaptive Gate Control Enabling Switching Period (Note 7)	The time duration from $V_{GATE1}(n-1)$ rising edge to $V_{GATE1}(n)$ rising edge at $T_J < T_{OTP1}$. in ALC, ALK, ALL, ALS, BLC, ALFP, ALGP in AHD, AHJ	4	5 4	6.1	μs
I_{SOURCE}	Peak Sourcing Current of Gate Driver (Note 7)			1.5		A
I_{SINK}	Peak Sinking Current of Gate Driver (Note 7)			4.5		A
$R_{DRV-SOURCE}$	Gate Driver Sourcing Resistance (Note 7)			8		Ω
$R_{DRV-SINK}$	Gate Driver Sinking Resistance (Note 7)			1.5		Ω
t_R	Rise Time	$V_{DD} = 12\text{ V}$, $C_{GATE} = 3.3\text{ nF}$, $V_{GATE} = 1 \rightarrow 6\text{ V}$ at $T_J = 25\text{ }^{\circ}\text{C}$		50	150	ns
t_F	Fall Time	$V_{DD} = 12\text{ V}$, $C_{GATE} = 3.3\text{ nF}$, $V_{GATE} = 6 \rightarrow 1\text{ V}$ at $T_J = 25\text{ }^{\circ}\text{C}$		30	50	ns

Product parametric performance is indicated in the Electrical Characteristics for the listed test conditions, unless otherwise noted. Product performance may not be indicated by the Electrical Characteristics if operated under different conditions.

7. Not tested but guaranteed by design

8. In ALFP, GATE signal is always turned off by the VTH-OFF-RST threshold, regardless of dead time. IOFFSET will stay at 0.

NCP4318

IC OPTIONS

Option	Drain Sensing Pin	Frequency	DLY_EN	V _{GATE}	t _{GATE-LIM}	T _{OTP1} / T _{OTP2}
NCP4318AHD	#4, #6	H-version	Variable	1-Level (10 V)	Disable	130 °C / Disable
NCP4318AHJ	#4, #6	H-version	Variable	1-Level (10 V)	Disable	105 °C / 140 °C
NCP4318ALC	#4, #6	L-version	Variable	2-Level (10 V, 6 V)	Disable	105 °C / 140 °C
NCP4318BLC	#3, #6	L-version	Variable	2-Level (10 V, 6 V)	Disable	105 °C / 140 °C
NCP4318ALK	#4, #6	L-version	Variable	1-Level (10 V)	Disable	130 °C / Disable
NCP4318ALL	#4, #6	L-version	Variable	1-Level (10 V)	Disable	130 °C / Disable
NCP4318ALS	#4, #6	L-version	Always High	1-Level (10 V)	Disable	130 °C / Disable
NCP4318ALFP	#4, #6	L-version	Variable	1-Level (10 V)	Disable	130 °C / Disable
NCP4318ALGP	#4, #6	L-version	Variable	1-Level (10 V)	Disable	130 °C / Disable

Option	t _{INV} (ns)	t _{ON-DLY2} (ns)	Dead-time Regulation	t _{DEAD-LBAND} (ns)	t _{OFF-MIN} (μs)	t _{GATE-SKIP1} (ns) / t _{GATE-SKIP2} (ns)	t _{GRN1-ENT} (μs) / t _{GRN2-ENT} (μs)	f _{HFS-EN} (kHz)
NCP4318AHD	170	240	Enable	170	1.15	550 / 385	40 / 4	250
NCP4318AHJ	170	240	Enable	170	1.15	550 / 385	40 / 4	250
NCP4318ALC	320	240	Enable	90	2	710 / 510	60 / 6	200
NCP4318BLC	320	240	Enable	90	2	710 / 510	60 / 6	200
NCP4318ALK	320	240	Enable	90	2	710 / 510	60 / 6	200
NCP4318ALL	320	240	Enable	90	2	710 / 510	60 / 6	200
NCP4318ALS	520	240	Enable	90	0.8	710 / 510	60 / 6	200
NCP4318ALFP	170	240	Disable	90	2	710 / 510	n.a. / 6	200
NCP4318ALGP	170	240	Enable	90	2	710 / 510	n.a. / 6	200

Option	V _{TH-HGH} (V)	V _{TH-OFF} Range (mV)	V _{TH-OFF-STEP} (mV)	V _{TH-OFF-RST} (mV)	V _{SD-PRI} (mV)	K _{TON1} (%) / K _{TON2} (%)
NCP4318AHD	0.85	-14 ~ 110	4	-10	100	52 / 22
NCP4318AHJ	0.85	-14 ~ 110	4	-10	100	52 / 22
NCP4318ALC	0.85	-6 ~ 118	4	2	150	52 / 22
NCP4318BLC	0.85	-6 ~ 118	4	2	150	52 / 22
NCP4318ALK	0.85	-6 ~ 242	8	10	150	52 / 22
NCP4318ALL	0.85	-6 ~ 118	4	2	500	52 / 22
NCP4318ALS	1.5	-6 ~ 242	8	10	200	52 / 22
NCP4318ALFP	0.85	-14 ~ 110	4	-6	150	34 / 17
NCP4318ALGP	0.85	-14 ~ 110	4	-10	150	34 / 17

9. f_{HFS-EN} = 1 / t_{HFS-EN}.

TYPICAL PERFORMANCE CHARACTERISTICS

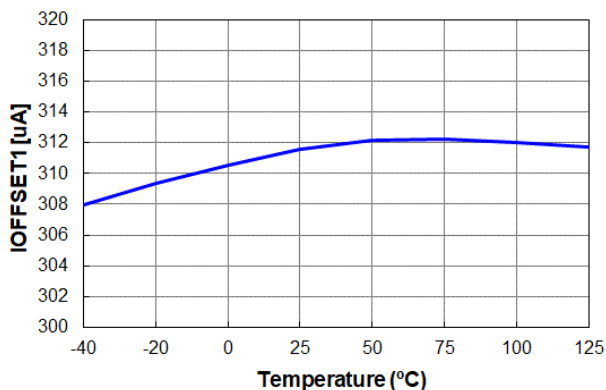

Figure 3. I_OFFSET1 vs. Temperature

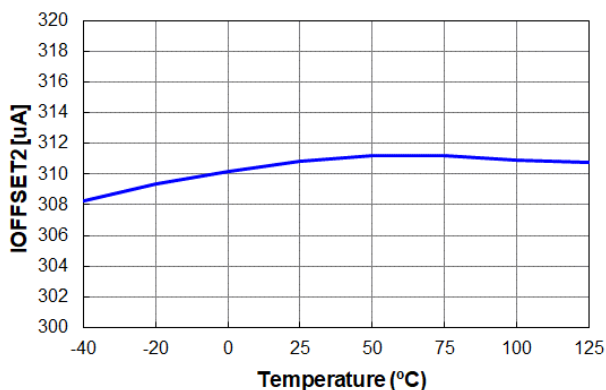

Figure 4. I_OFFSET2 vs. Temperature

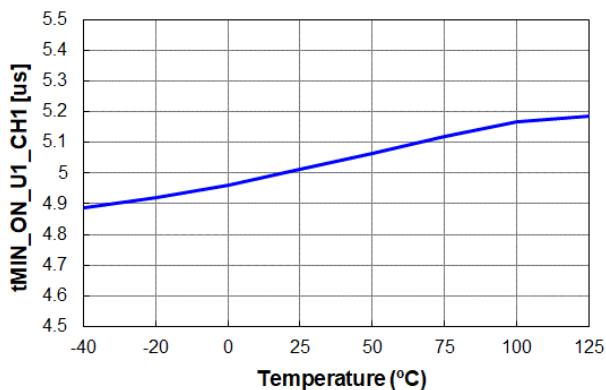

Figure 5. t_MIN-ON-U1-CH1 vs. Temperature

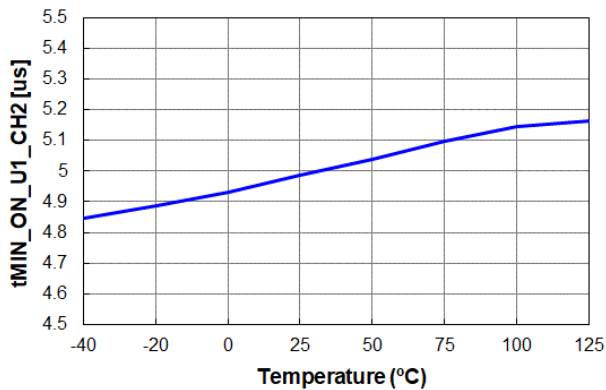

Figure 6. t_MIN-ON-U1-CH2 vs. Temperature

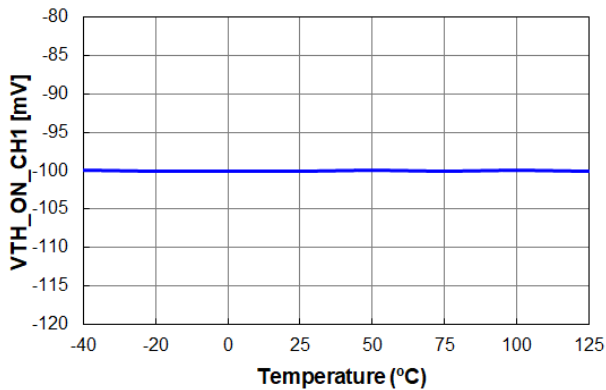

Figure 7. V_TH-ON-CH1 vs. Temperature

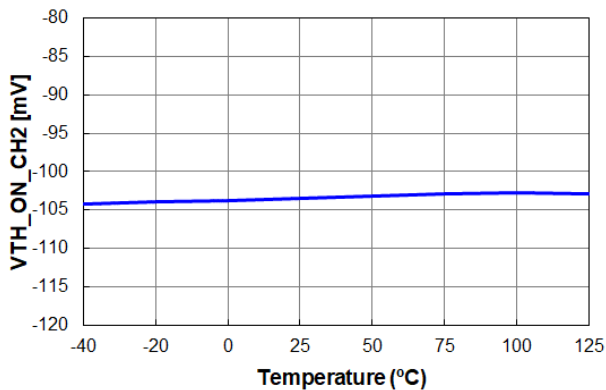

Figure 8. V_TH-ON-CH2 vs. Temperature

TYPICAL PERFORMANCE CHARACTERISTICS

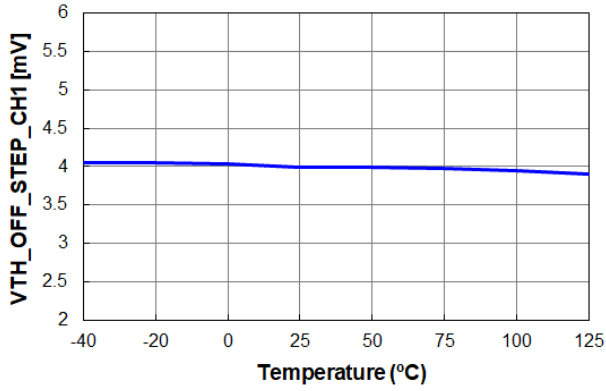

Figure 9. V_{TH-OFF-STEP-CH1} vs. Temperature

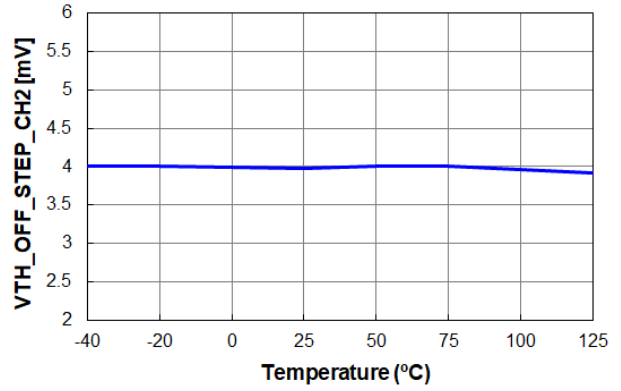

Figure 10. V_{TH-OFF-STEP-CH2} vs. Temperature

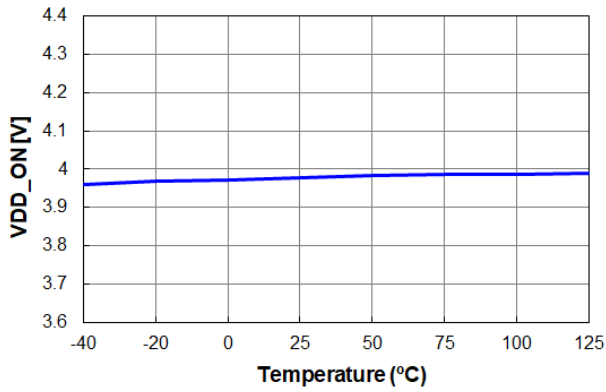

Figure 11. V_{DD-ON} vs. Temperature

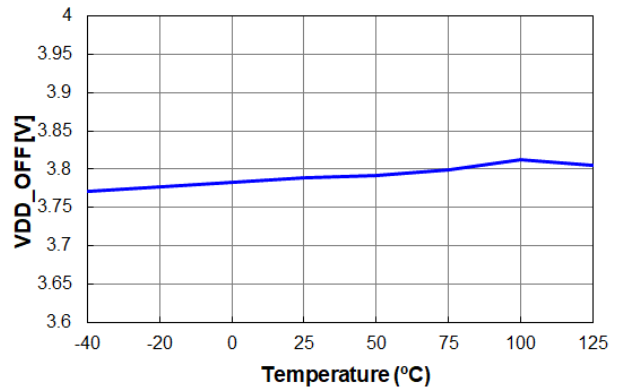

Figure 12. V_{DD-OFF} vs. Temperature

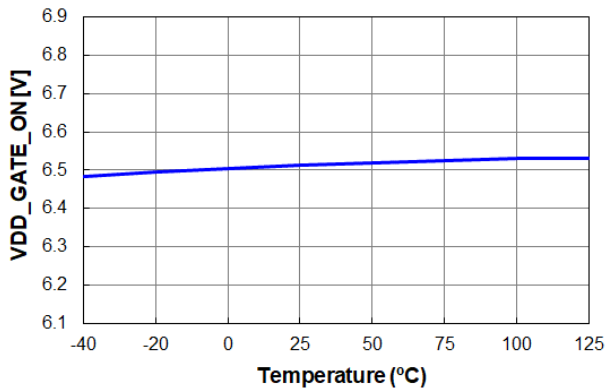

Figure 13. V_{DD-GATE-ON} vs. Temperature

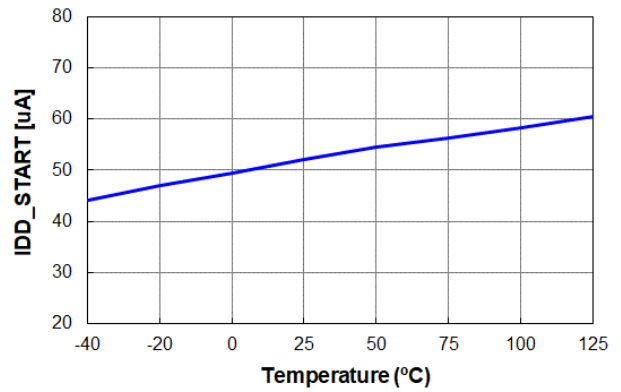

Figure 14. I_{DD-START} vs. Temperature

TYPICAL PERFORMANCE CHARACTERISTICS

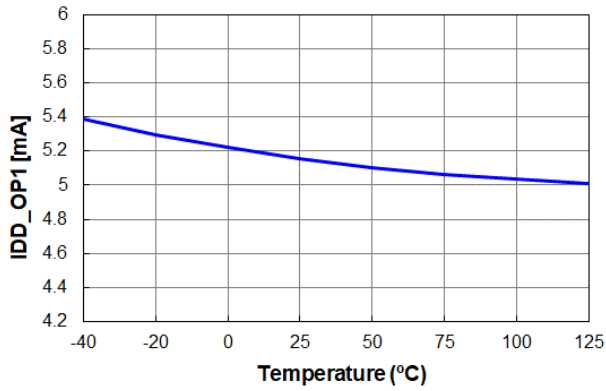

Figure 15. I_{DD-OP1} vs. Temperature

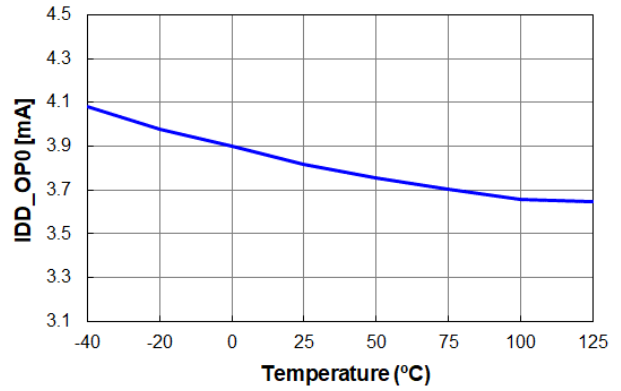

Figure 16. I_{DD-OP0} vs. Temperature

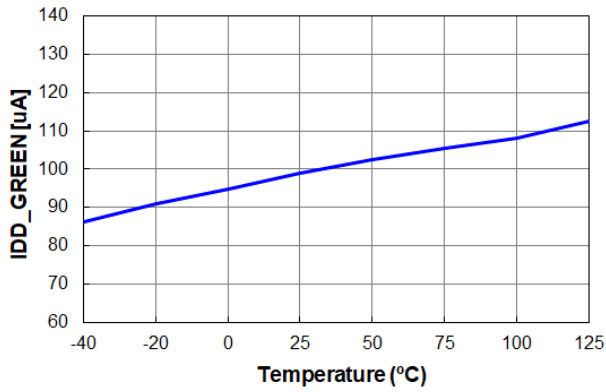

Figure 17. $I_{DD-GREEN}$ vs. Temperature

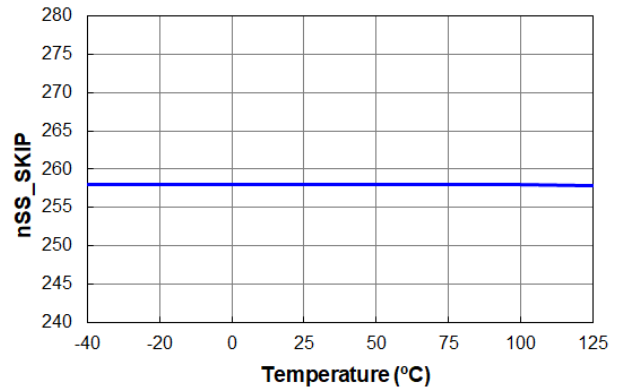

Figure 18. $n_{SS-SKIP}$ vs. Temperature

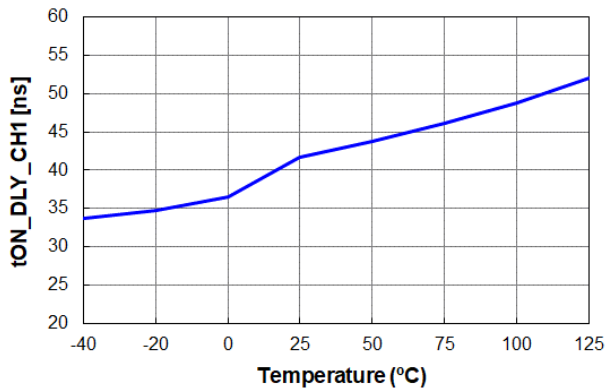

Figure 19. $t_{ON-DLY-CH1}$ vs. Temperature

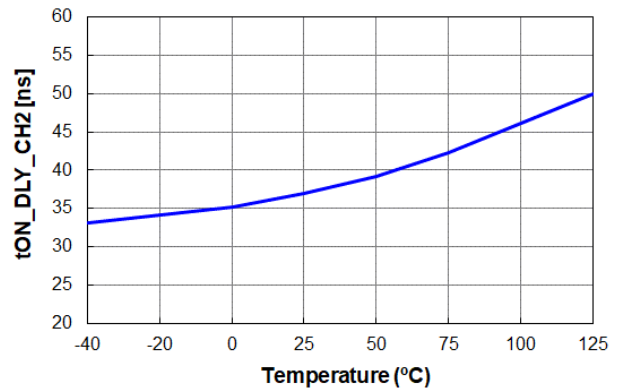

Figure 20. $t_{ON-DLY-CH2}$ vs. Temperature

TYPICAL PERFORMANCE CHARACTERISTICS

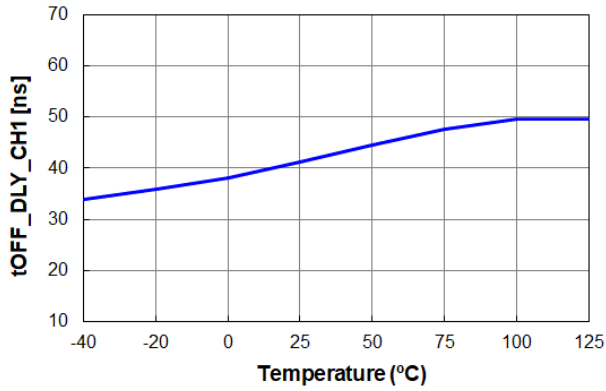

Figure 21. t_{OFF-DLY-CH1} vs. Temperature

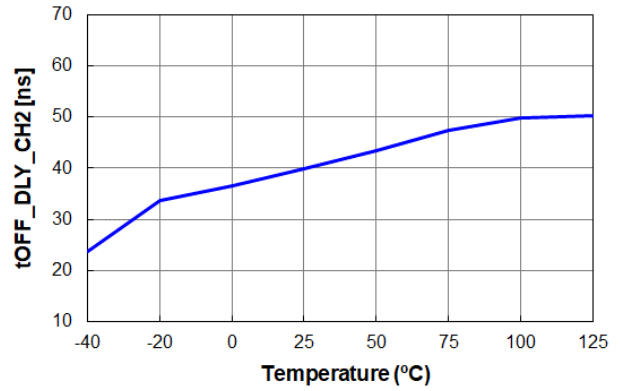

Figure 22. t_{OFF-DLY-CH2} vs. Temperature

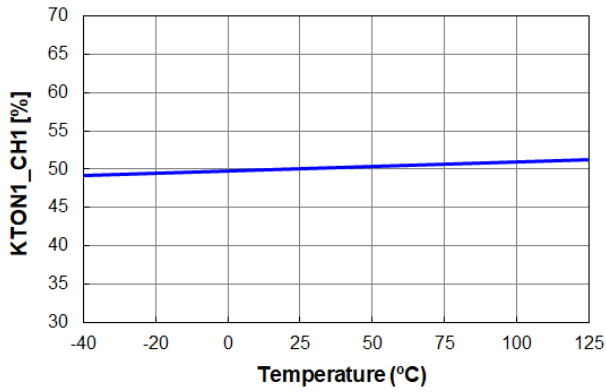

Figure 23. K_{TON1-CH1} vs. Temperature

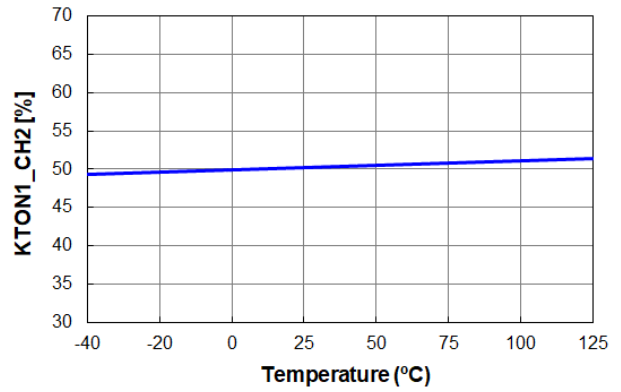

Figure 24. K_{TON1-CH2} vs. Temperature

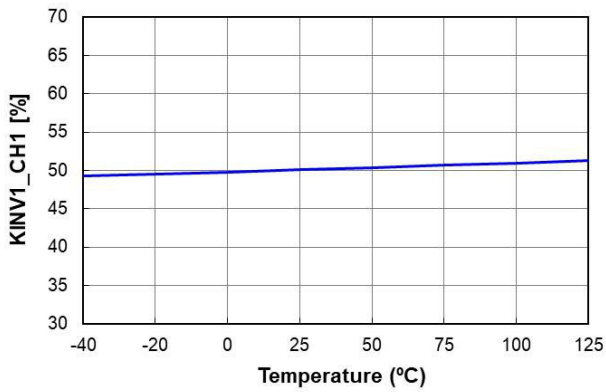

Figure 25. K_{INV1-CH1} vs. Temperature

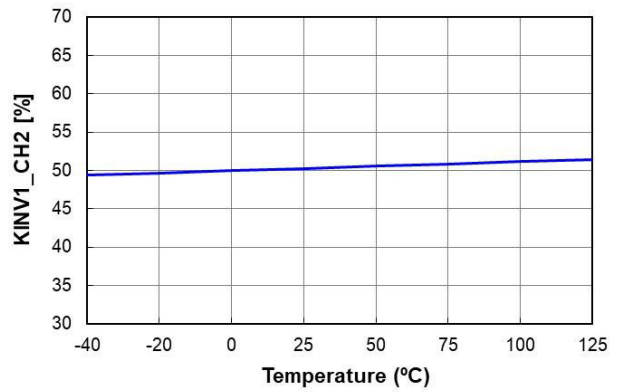

Figure 26. K_{INV1-CH2} vs. Temperature

TYPICAL PERFORMANCE CHARACTERISTICS

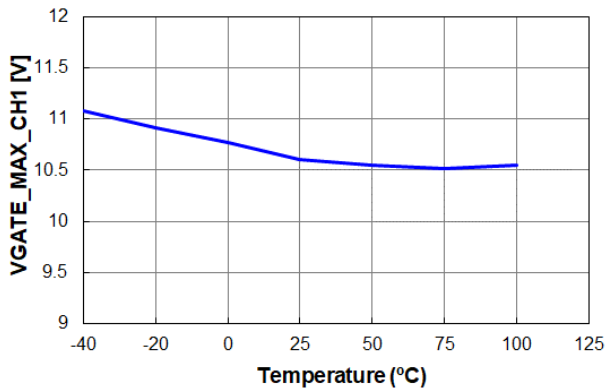

Figure 27. $V_{GATE_MAX_CH1}$ vs. Temperature

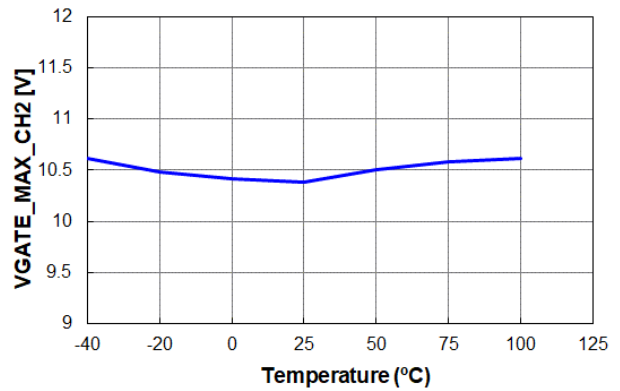

Figure 28. $V_{GATE_MAX_CH2}$ vs. Temperature

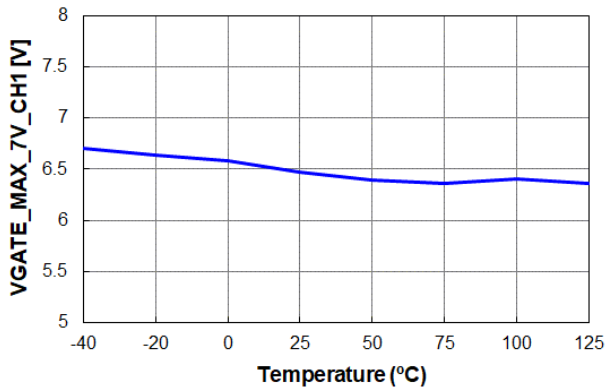

Figure 29. $V_{GATE_MAX_7V_CH1}$ vs. Temperature

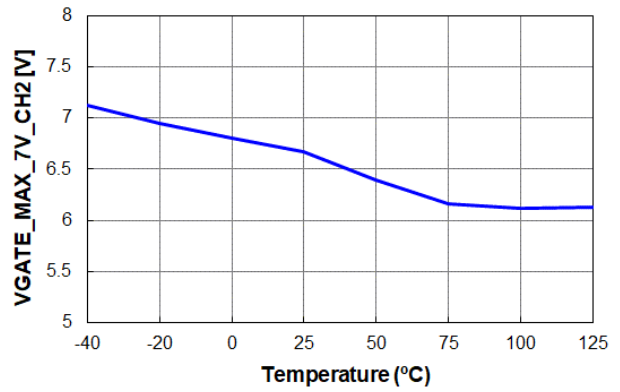

Figure 30. $V_{GATE_MAX_7V_CH2}$ vs. Temperature

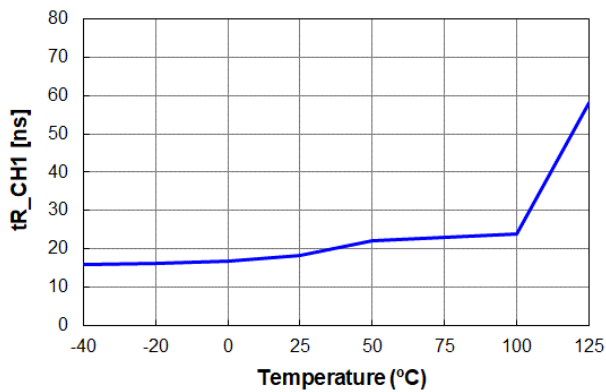

Figure 31. t_{R_CH1} vs. Temperature

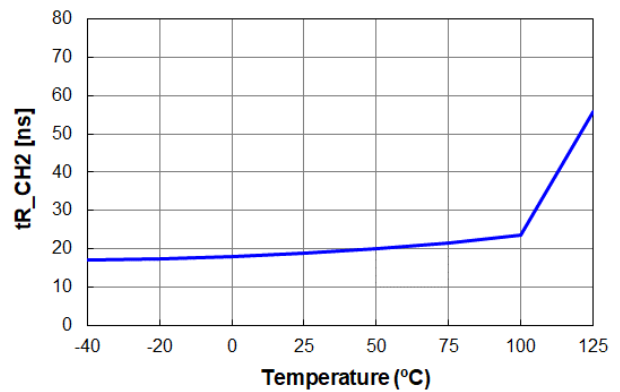

Figure 32. t_{R_CH2} vs. Temperature

TYPICAL PERFORMANCE CHARACTERISTICS

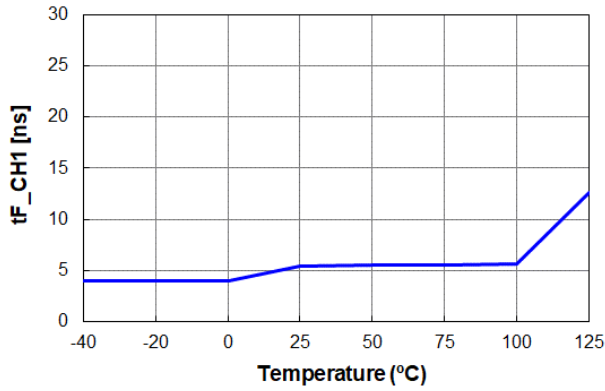

Figure 33. t_{F-CH1} vs. Temperature

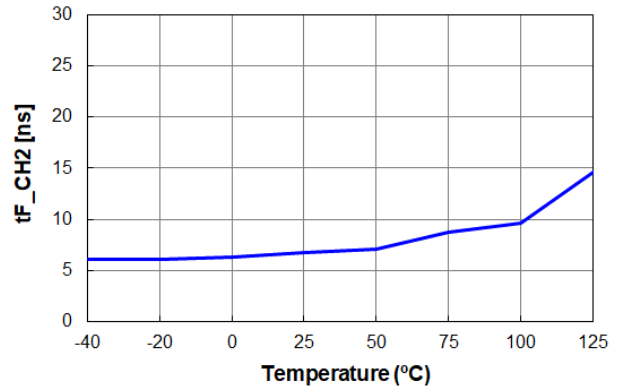

Figure 34. t_{F-CH2} vs. Temperature

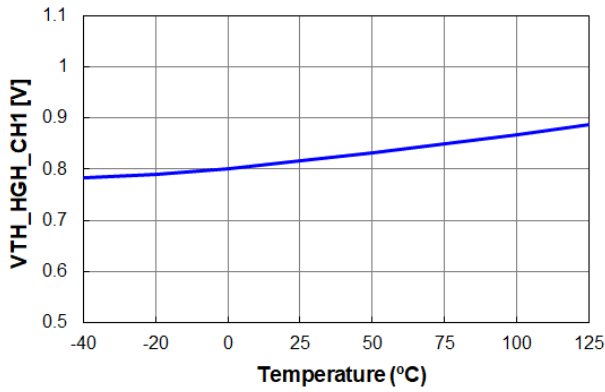

Figure 35. $V_{TH-HIGH-CH1}$ vs. Temperature

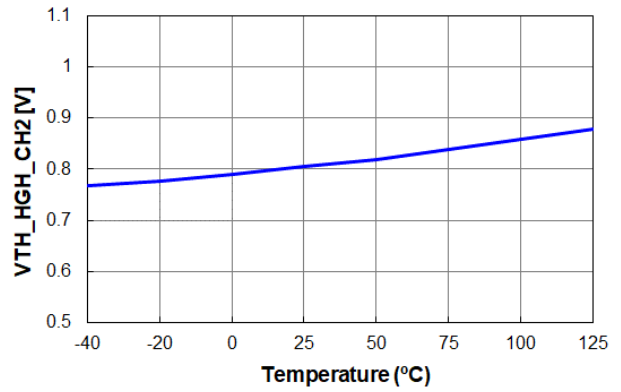

Figure 36. $V_{TH-HIGH-CH2}$ vs. Temperature

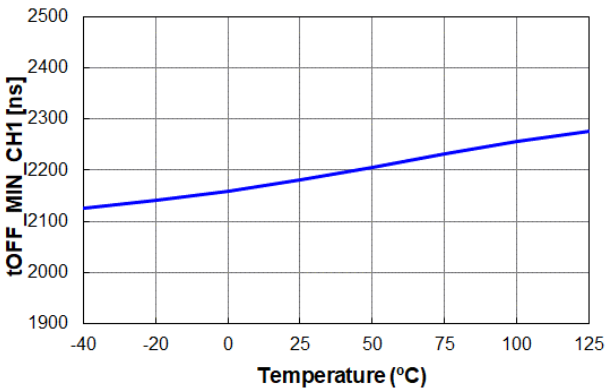

Figure 37. $t_{OFF-MIN-CH1}$ vs. Temperature

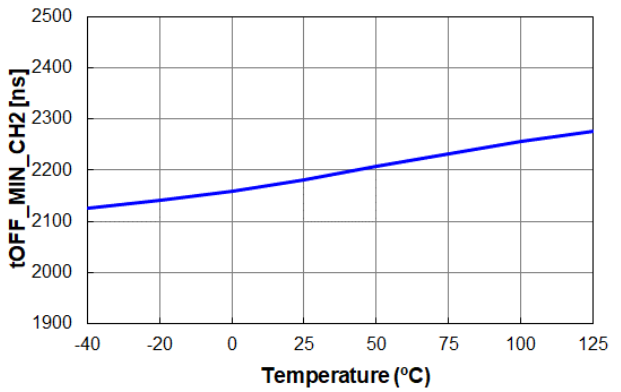

Figure 38. $t_{OFF-MIN-CH2}$ vs. Temperature

TYPICAL PERFORMANCE CHARACTERISTICS

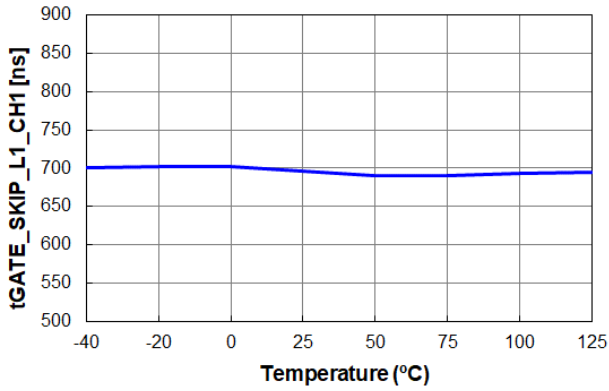

Figure 39. t_{GATE_SKIP1-CH1} vs. Temperature

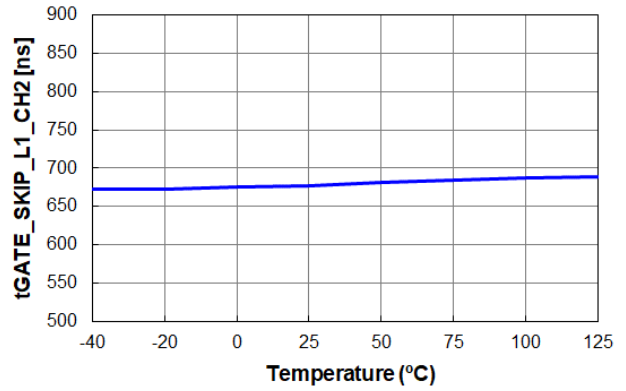

Figure 40. t_{GATE_SKIP1-CH2} vs. Temperature

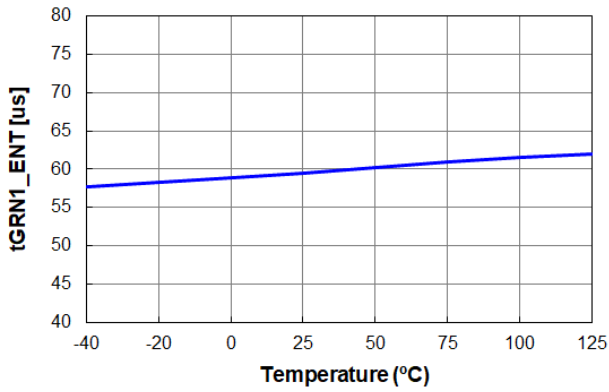

Figure 41. t_{GRN1-ENT} vs. Temperature

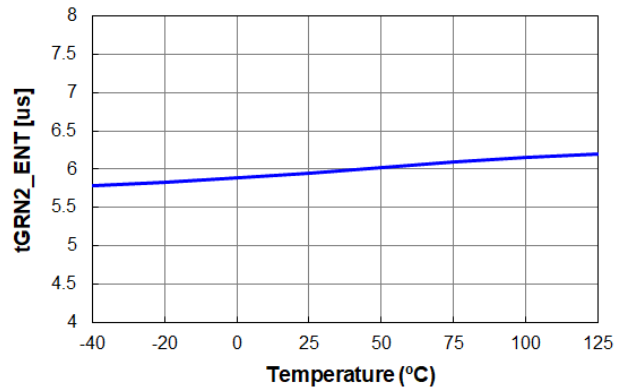

Figure 42. t_{GRN2-ENT} vs. Temperature

APPLICATIONS INFORMATION

Basic Operation Principle

NCP4318 controls the SR MOSFETs based on the instantaneous drain-to-source voltage sensed across the drain and source pins of the MOSFET. Before SR gate turning on, SR body diode operates as the conventional diode rectifier. Referring to Figure 46, the conducting body diode makes the drain-to-source voltage drops below the turn-on threshold voltage V_{TH-ON} and triggers the turn-on of the SR gate. After the SR gate turning on, the product of on resistance R_{DS-ON} of the SR MOSFET and the instantaneous SR current determines the drain-to-source voltage.

When the drain-to-source voltage reaches the turn-off threshold voltage V_{TH-OFF} , as SR MOSFET current decreases to near zero, NCP4318 turns off the gate. If SR dead time is larger or smaller than the dead time regulation target, NCP4318 adaptively changes a virtual turn-off threshold voltage to regulate the dead time between $t_{DEAD-LBAND}$ and $t_{DEAD-HBAND}$, so to maximize system efficiency.

SR Turn-on Algorithm

When V_D is lower than V_{TH-ON} by body diode conduction of SR MOSFET, turn-on comparator $COM1$ toggles high. If an additional delay flag signal DLY_EN is low, V_G goes high with only 30 ns of t_{ON-DLY} and GATE sources 1.5 A of I_{SOURCE} to turn on the SR MOSFET.

On the other hand, if the DLY_EN flag is HIGH due to current inversion detection $SRCINV$ or green-mode preparation $GREEN2$, additional turn-on delay is applied by an adaptive turn-on delay block. In this case, SR gate is turned on when the body diode conduction time is confirmed to be longer than $t_{ON-DLY2}$.

SR Turn-off Algorithm

The SR turn-off method determines safe and stable SR operation. One of the conventional methods turns off the SR gate based on the instantaneous drain voltage (present information). This method is widely used and easy to realize, and it can prevent late turn-off with appropriate turn-off threshold voltage. However, it frequently shows premature turn-off due to parasitic stray inductances of PCB trace and package of the SR MOSFET. On the other hand, SR gate on-time is predicted by inspecting previous-cycle drain voltage information. It can prevent the premature turn-off, providing good performance for the system with constant operating frequency and SR conduction duration. However, in case of the frequency changing, the on-time prediction may lead to late turn-off during frequency increasing event, leading to negative current flowing in the secondary side of the LLC converter.

To gain the advantages of both methods, NCP4318 adopts a mixed type turn-off algorithm, which modulate a virtual turn-off threshold voltage (V_{TH-OFF}) to regulate the turn-off dead time within a hysteresis band. As shown in Figure 45, the instantaneous drain voltage V_D is compared with a

virtual V_{TH-OFF} to turn off the SR gate. The virtual V_{TH-OFF} is adaptively changed to compensate the effect of stray inductance and regulate a t_{DEAD} between $t_{DEAD-LBAND}$ and $t_{DEAD-HBAND}$. Therefore, NCP4318 can show robust operation with very small dead time.

The response time of the V_{TH-OFF} comparator is around 10–20 ns at room temperature, meaning $V_{VD} - V_{VS}$ needs to be higher than V_{TH-OFF} for more than 20 ns to guarantee turning-off of GATE signal. The total delay time of the turning-off, $t_{OFF-DLY}$, includes this response time and propagation delay of the gate-drive logic/circuit.

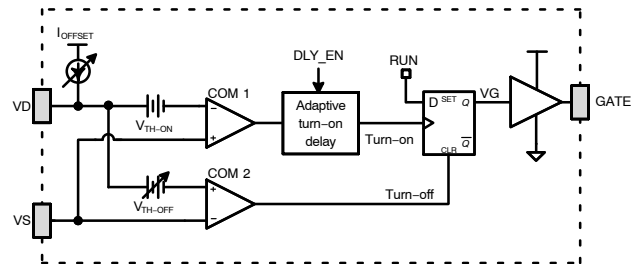

Figure 43. VDS-sensing Circuit

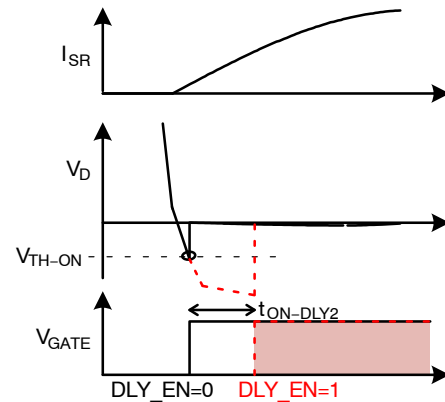

Figure 44. SR Turn-on Algorithm

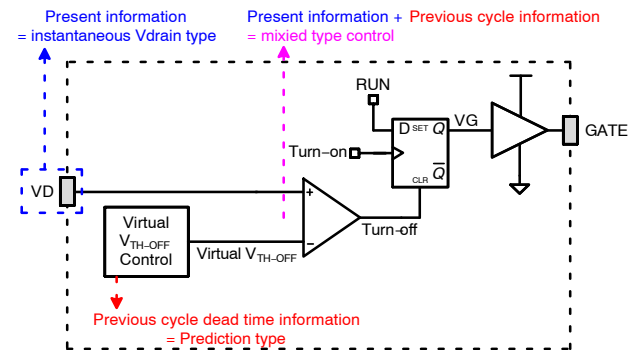

Figure 45. SR Turn-off Algorithm

Hysteresis-Band Dead-Time Regulation

The stray inductance of SR MOSFET induces a positive offset voltage across drain and source when the SR current

decreases. This makes drain-to-source voltage of SR MOSFET higher than the product of R_{DS-ON} and the instantaneous SR current, which results in premature SR turn-off as shown in Figure 46 (a). The induced offset voltage changes as the output load varying, so, to keep a fixed SR dead time, the turn-off threshold voltage needs to be tuned. NCP4318 utilizes the virtual V_{TH-OFF} , which is comprised of 31 steps of turn-off threshold voltages $V_{TH-OFF(n)}$ and 31 steps of offset current $I_{OFFSET(n)}$ as shown in Figure 46 (b) and Figure 47. The turn-off condition and the virtual turn-off threshold voltage can be expressed as:

$$V_{DS} + I_{OFFSET} \cdot R_{OFFSET} - V_{TH-OFF} = 0 \quad (\text{eq. 1})$$

$$\text{Virtual } V_{TH-OFF} = V_{TH-OFF} - R_{OFFSET} \cdot I_{OFFSET} \quad (\text{eq. 2})$$

where R_{OFFSET} is the external drain sensing resistance.

V_{TH-OFF} modulates between $V_{TH-OFF-MIN}$ and $V_{TH-OFF-MAX}$ with a step size of $V_{TH-OFF-STEP}$, and I_{OFFSET} varies between 0 and 310 μA with 10 μA of step size. I_{OFFSET} means to provide a finer tuning on the virtual V_{TH-OFF} . When the I_{OFFSET} has saturated to maximum or minimum values, V_{TH-OFF} changes to its next step for a coarse control. So, designing the R_{OFFSET} resistance as $V_{TH-OFF-STEP} / 310 \mu\text{A}$ gives a linear virtual V_{TH-OFF} sweeping range. Typically, 30 Ω R_{OFFSET} is used when $V_{TH-OFF-STEP}$ is 8 mV, and 15 Ω for 4 mV.

Dead time is defined as the duration from V_{GATE} turning off to VD exceeding V_{TH-HGH} . V_{GATE} turning off is defined as the moment that voltage on GATE1/GATE2 pin is crossing a $V_{GATE-LOW}$ threshold by falling. $V_{GATE-LOW}$ is 3.7 V in general, but it is 2.8 V for IC options with 5 V V_{GATE} or 3-level V_{GATE} .

In Figure 48 (a), the measured dead time t_{DEAD} is larger than upper band of $t_{DEAD-HBAND}$. To reduce t_{DEAD} , the virtual V_{TH-OFF} will be increased by one-step decrease of I_{OFFSET} within 128 switching cycles. As a result, t_{DEAD} decreases and becomes much closer to $t_{DEAD-HBAND}$, as shown in Figure 48 (b).

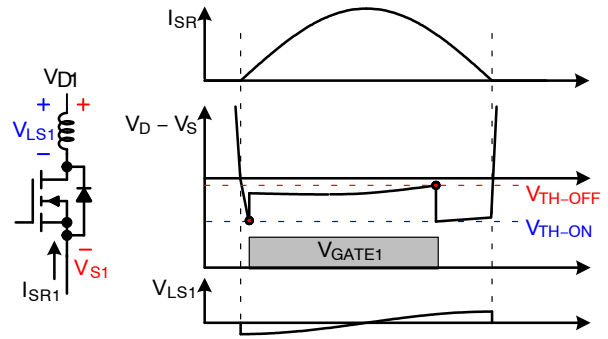

(a) Premature SR Turn-off by Stray Inductance

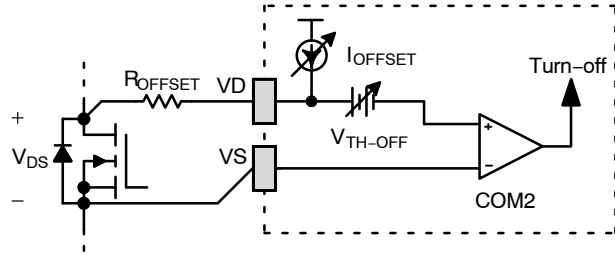

(b) Detailed SR Turn-off Circuitry

Figure 46. Virtual V_{TH-OFF}

Similarly, when the dead time is shorter than $t_{DEAD-LAND}$, the virtual V_{TH-OFF} will reduce in the following switching cycle. When the dead time is placed between $t_{DEAD-LBAND}$ and $t_{DEAD-HBAND}$ as in Figure 49, the virtual V_{TH-OFF} stays as-is. Therefore, the dead time is regulated between $t_{DEAD-LBAND}$ and $t_{DEAD-HBAND}$ regardless of parasitic inductances. This hysteresis-band dead-time control provides stable operation across load variation by minimizing the variation of the dead time.

The initial and reset condition of the virtual V_{TH-OFF} is $V_{TH-OFF} = V_{TH-OFF-RST}$ and $I_{OFFSET} = 310 \mu\text{A}$.

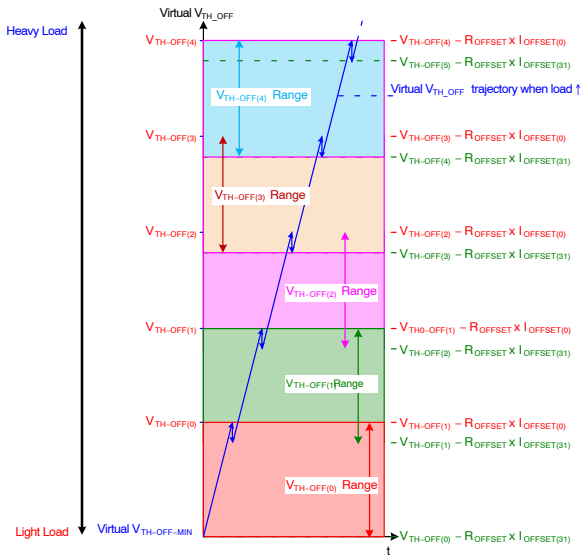

Figure 47. Virtual V_{TH-OFF} Trajectory when Load Increases

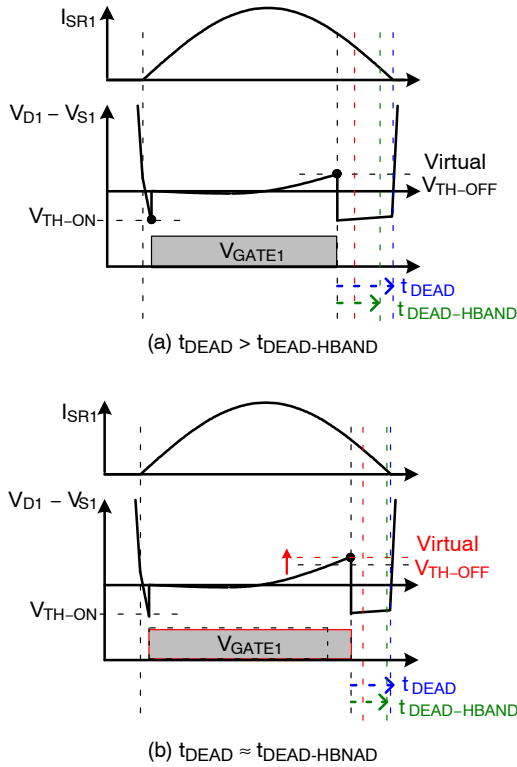

Figure 48. Dead-time Regulation

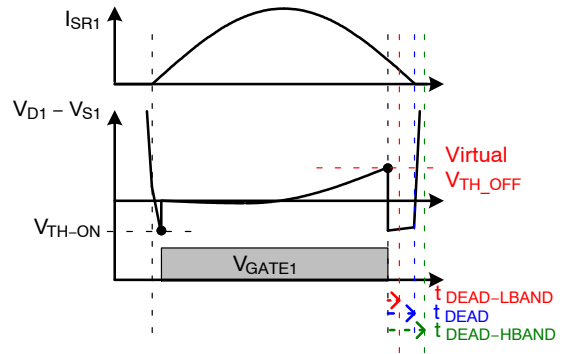

Figure 49. $t_{DEAD} \in [t_{DEAD-LBAND}, t_{DEAD-HBAND}]$

Light Load Detection (LLD)

When the output load increases, due to larger current amplitude in the SR current, the dead-time regulation modulates the V_{TH-OFF} higher. Thus, the V_{TH-OFF} indicates the output load condition.

There are totally 31 steps of V_{TH-OFF} , noted as $V_{TH-OFF(0)} \sim V_{TH-OFF(31)}$. When the output load increases, by the dead-time regulation, V_{TH-OFF} tends to increase. When V_{TH-OFF} 's step number $n \leq \eta_{LLD1}$ on channel 1, NCP4318 detects a light load condition. So, light load detection flag signal LLD set to '1'. When the load keeps reducing, making $n \leq \eta_{LLD2}$, LLD is set to '2'. At heavier load and $n > \eta_{LLD1}$, LLD becomes '0'. This LLD signal is used for $SRCINV$ detection threshold voltage control and adaptive V_{GATE} control.

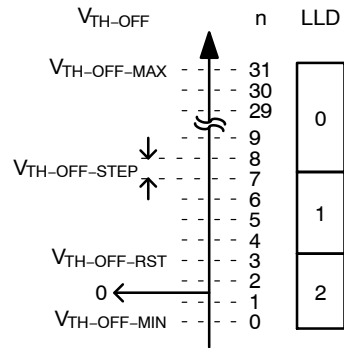

Figure 50. V_{TH-OFF} Steps and the LLD Flag ($\eta_{LLD1} = 7$, $\eta_{LLD2} = 3$, $\eta_{V_{TH-OFF-RST}} = 3$)

Advanced Adaptive Minimum Turn-on Time

When SR gate is turning on, there may be severe oscillation in the drain-to-source voltage of the SR MOSFET, which may result in several turn-off mis-triggering as shown in Figure 51. To provide stable SR gate signal without short pulses, it is desirable to have large turn-off blanking time (= minimum turn-on time) until the drain voltage oscillation attenuates. However, too large blanking time results in an inversion current problem under light load condition where the SR conduction time may be shorter than the minimum turn-on time.

To solve this issue, NCP4318 has an adaptive minimum turn-on time, t_{MIN-ON} , where the turn-off blanking time changes in accordance with the SR conduction time $t_{SRCOND(n-1)}$ measured in previous switching cycle. The SR conduction time is measured from SR gate rising edge to the drain sensing voltage V_D being higher than V_{TH-HGH} . t_{MIN-ON} in the n-th switching cycle is defined as 50% of $t_{SRCOND(n-1)}$ as shown in Figure 52. During t_{MIN-ON} , SR gate won't be turned off by the virtual V_{TH-OFF} . The minimum and maximum values of t_{MIN-ON} are defined as 200 ns and $t_{MIN-ON-UI}$ respectively. When the additional turn-on delay flag DLY_EN is high in the light load condition, t_{MIN-ON} becomes 20% of $t_{SRCOND(n-1)}$ as shown in Figure 53.

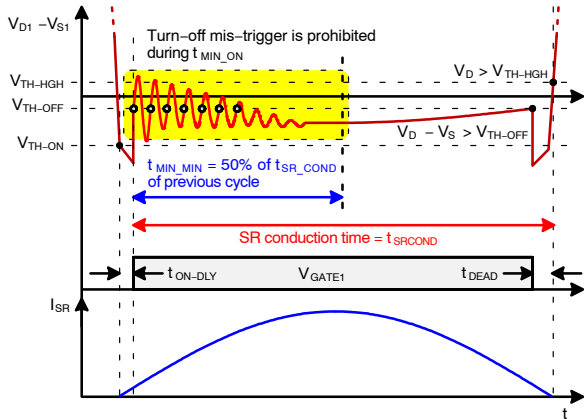

Figure 51. Minimum Turn-on time and Turn-off Mis-triggering

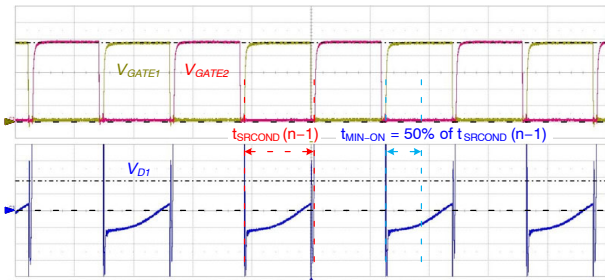

Figure 52. Minimum Turn-on Time t_{MIN-ON} when $DLY_EN=0$

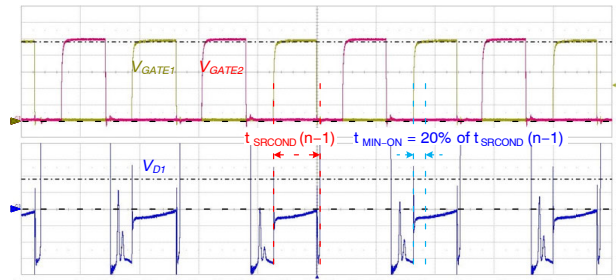

Figure 53. Minimum Turn-on Time t_{MIN-ON} when $DLY_EN=1$

Multi-step V_{TH-OFF}

In heavy-load conditions, V_{TH-OFF} tends to be high. When the switching frequency on the primary side suddenly increases from the heavy-load condition, the SR current conduction duration reduces accordingly. To make the SR controller timely reacts to this transition, we implements a multi-step V_{TH-OFF} function to reduce the effective V_{TH-OFF} , turning off the SR gate earlier, during this transition. Referring to the SR gate on-time of previous switching cycle, before the SR gate on-time reaches 70% ($K_{2ND-TOFF}$) of the previous-cycle on-time, the effective V_{TH-OFF} is temporarily reduces to 60% ($K_{2ND-VOFF}$) of its real value. Thus, the SR gate can be turned off with a lower V_{TH-OFF} during the frequency-increasing transition, providing a safer operation. The multi-step V_{TH-OFF} function is active when $LLD = 0$.

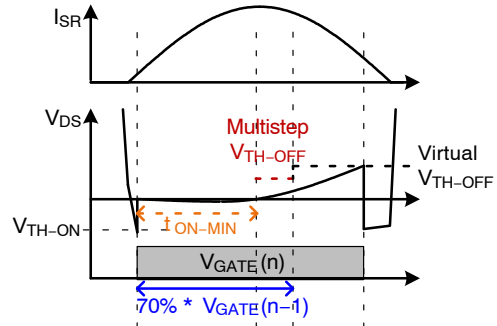

Figure 54. $t_{DEAD} \in [t_{DEAD-LBAND}, t_{DEAD-HBAND}]$

Current Inversion Detection

During SR operation, two types of inversion current may occur. First, in light load condition, capacitive current spike causes leading edge inversion current. In heavy load condition, the body diode of SR MOSFET starts conducting right after the primary side switching transition taking place. However, when the resonance-capacitor voltage amplitude is not large enough in light load condition, the voltage across the magnetizing inductance of the transformer is smaller than the reflected output voltage. Thus, the secondary side SR body diode conduction is delayed until the magnetizing inductor voltage builds up to the reflected output voltage.

However, the primary side switching transition can cause capacitive current spike and turn on the body diode of SR MOSFET for a short time as shown in Figure 55, which induces SR turn-on mis-trigger. As a result, the turn-on mis-trigger makes leading edge inversion current in the secondary side.

The second inversion current is trailing edge inversion current caused by excessive SR gate on-time, which is generally due to the minimum on-time t_{MIN-ON} . If t_{MIN-ON} is longer than current transferring duration, trailing edge inversion current can happen as shown in Figure 56. If there is no proper algorithm to prevent this inversion current, severe drain voltage spike can happen due to SR MOSFET hard switching.

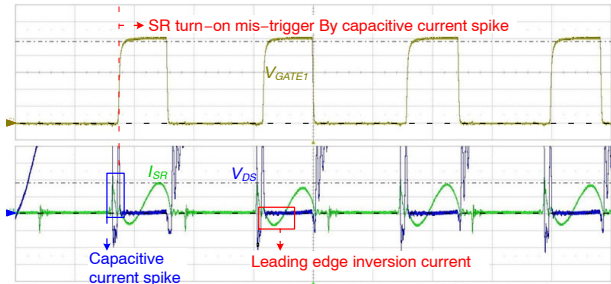

Figure 55. Leading Edge Inversion Current

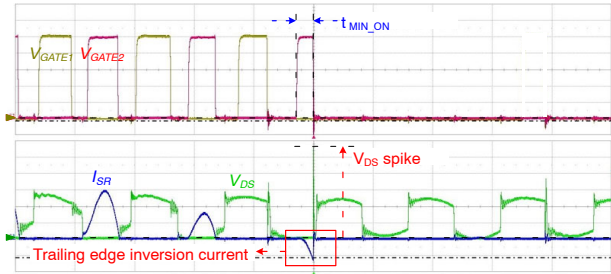

Figure 56. Trailing Edge Inversion Current

To prevent both leading edge and trailing edge inversion currents, NCP4318 has a current inversion detection function *SRCINV*. This function is effective during t_{MIN-ON} . When the SR gate is turned on and the inversion current occurs, the drain sensing voltage of SR MOSFET becomes a positive value. In this condition, if V_{DS} is higher than 0 mV for t_{INV} of the detection confirmation time, *SRCINV* will be triggered and turn off the SR gate immediately. Then, the *DLY_EN* flag goes high and the turn-on delay is increased to $t_{ON-DLY2}$ for the following switching cycles.

When the *LLD* flag is high, V_{TH-OFF} tends to be low, and the V_{TH-OFF} replaces the 0-mV threshold voltage for *SRCINV*. If the gate on-time is longer than t_{MIN-ON} , the virtual V_{TH-OFF} turn-off mechanism will turn off the gate properly.

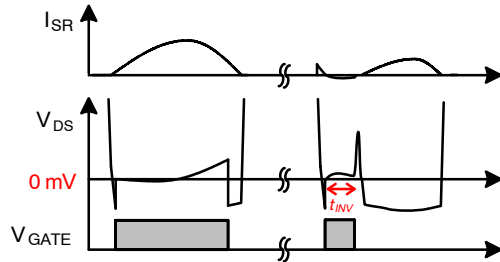

Figure 57. Triggering SRCINV by Leading-edge Inversion Current

Green Mode

In NCP4318, there are two stages to trigger *GREEN* function. *GREEN1* is for low power consumption in light load condition, and *GREEN2* is for preparing a *GREEN1* triggering.

When the LLC controller in the primary side operates in skip mode under light load conditions, making V_{D1} shows no switching waveform for longer than $t_{GRN1-ENT}$, the *GREEN1* mode will be activated as shown in Figure 58. Once NCP4318 is in the *GREEN1* mode, all the major functions are disabled to reduce the operating current down to 100 μ A of $I_{DD-GREEN}$. NCP4318 exits from *GREEN1* when four switching cycles are observed from V_{D1} as shown in Figure 59.

Before *GREEN1* being triggered, if the duration of no switching operation is longer than $t_{GRN2-ENT}$, a short *GREEN2* pulse is generated to reset the virtual V_{TH-OFF} and assert DLY_EN . LLD may also be asserted when V_{TH-OFF} resets to a level lower than η_{LLD1} . Doing so, *GREEN2* prepares a new SR operation starting condition and allows soft increment of SR gate pulses for the next switching bundle.

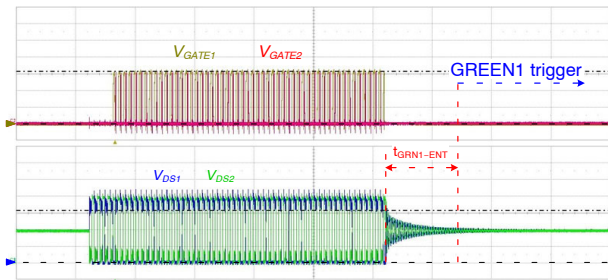

Figure 58. Entering *GREEN1*

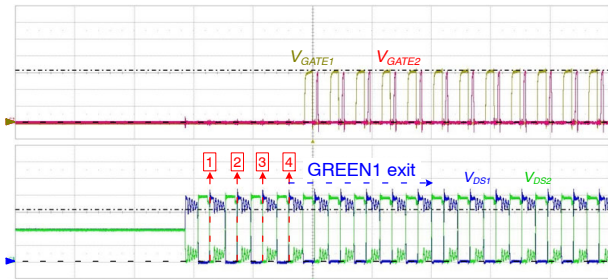

Figure 59. Exit from *GREEN1*

Limitation on SR Gate On-time Increasing Rate

To better cope with transitions of operating frequency, NCP4318 has an optional SR gate on-time increasing-rate limitation function. When this function is enable, the on-time of consecutive SR-gate pulses won't increase too much from their precedent pulse. The increase rate is limited as 550 ns of $t_{GATE-LIM}$ between two consecutive pulses. In other words, when the on-time should change from a smaller value to a larger value, the SR gate takes a few switching cycle to increase its pulse width gradually.

More, when this function is enabled, the maximum pulse width of the SR gate start from 1.2 μ s after a *GREEN2* or *SRCINV* event. The maximum pulse width increases up to $t_{SR-MAX-ON}$.

Adaptive V_{GATE} Control

Lowering the gate clamping voltage V_{GATE} reduces gate drive power consumption. Adaptive V_{GATE} control reduces V_{GATE} level when it is a better choice of operation. In NCP4318, there are three condition to trigger the adaptive V_{GATE} . First is the output load condition. In light load condition, to save the SR gate driving current and maximize efficiency, NCP4318 adaptively changes V_{GATE} . As shown in Figure 60, when LLD goes from '0' to '1', the gate clamp voltage reduces from 10 V to 6 V. It could save 40% of gate driving power consumption. In heavy load condition, V_{GATE} resumes to 10 V for lower turn-on resistance R_{DS-ON} of the SR MOSFET, as depicted in Figure 61. There is also a 3-level- V_{GATE} option which set $V_{GATE} = 5$ V when $LLD = 2$.

The second condition is the operating frequency. If the LLC operating frequency is higher than 200 kHz of $f_{HFS-EN} = 1/t_{HFS-EN}$ in L-version and 250 kHz in H-version, NCP4318 reduces V_{GATE} for lowering SR gate driving current.

The last condition is junction temperature T_J of the IC. When T_J is higher than 105°C of T_{OTP1} , V_{GATE} reduces to 6 V to reduce heat dissipation of the IC. V_{GATE} resumes to 10 V when T_J is lower than 80°C of $T_{OTP-RST}$.

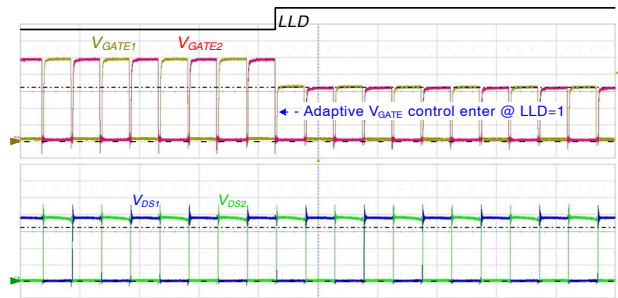

Figure 60. V_{GATE} Reduces when LLD is High

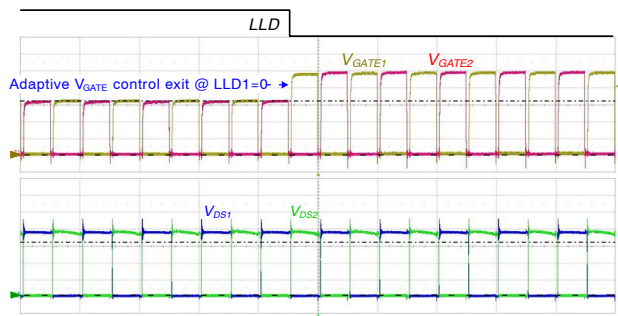

Figure 61. V_{GATE} Resumes When LLD is Low

Soft Start

At the beginning of LLC startup, the operating frequency is severely changed, and the symmetrical duty cycles between the high-side and low-side power switches on the primary side sometimes cannot be guaranteed. To avoid SR

operation during the startup transition, NCP4318 implements a soft-start function. After V_{DD} exceeds $V_{DD-GATE-ON}$, the SR gate skips the initial 256 consecutive V_{D1} and V_{D2} switching cycles to check whether LLC system is stable or not. After the first 256 cycles, NCP4318 starts generating SR gate pulses with $V_{GATE} = 6\text{ V}$ and $V_{TH-OFF} = V_{TH-OFF-RST}$. If LLD-based adaptive V_{GATE} is enabled, V_{GATE} stays 6 V until LLD signal goes to zero. Otherwise, V_{GATE} stays 6 V for another 256 cycles. This allows soft-increment of SR gate pulses and gradual reduction of the SR dead time at startup.

Protections

For higher system reliability, two protections are implemented in NCP4318. First one is the primary shutdown protection. In SR controller point of view, NCP4318 cannot know directly the primary side abnormal gate off, such as by a certain LLC protection or power-off. In that condition, SR gate should be turned off as soon as possible even in minimum on-time. Though $SRCINV$ function can turn-off SR gate at that moment, it has a certain delay time t_{INV} for the confirmation. For a faster turning off, a primary shutdown protection is implemented.

When the LLC gate signal in the primary side suddenly cuts down, SR current shows a downward transition, which induces a high dV/dt on the drain sensing voltage. If the dV/dt is higher than V_{SD-PRI}/t_{INV} , the primary shutdown protection is triggered and the SR gate turns off immediately. In addition, it asserts $GREEN1$, which makes 4 cycles of SR gate skipping to ignore turn-on mis-trigger caused by energy bouncing in the secondary side. The primary shutdown protection is effective in the leading edge of the SR gate for 70% of its previous-cycle SR gate on-time.

The other protection is the abnormal drain sensing protection. In normal condition, when the SR gate is turn on and higher than 4.5 V, the drain sensing voltage V_D is expected low, which in any case should not exceed V_{TH-HGH} . However, in abnormal condition, due to V_D fluctuation, V_D can be higher than V_{TH-HGH} even when $V_{GATE} > 4.5\text{ V}$. In that condition, NCP4318 triggers the abnormal drain sensing protection, turns off the SR gate and makes $GREEN1$ high.

To protect NCP4318 from overheating, NCP4318 stops operation when its junction temperature exceeds T_{OTP2} .

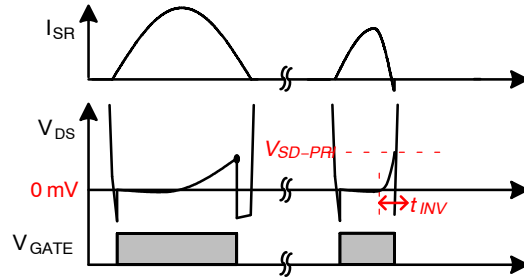

Figure 62. Triggering Primary Shutdown Protection

Recover From $t_{ON-DLY2}$

When the DLY_EN flag has been asserted, SR gate turns on after the body diode of the SR MOSFET conducts for $t_{ON-DLY2}$. NCP4318 clears the DLY_EN flag by observing the $V_D < V_{TH-ON}$ event. Before the SR gate turning on, if V_D crosses below V_{TH-ON} for only one time, a $\eta_{INV-EXT}$ counter adds by one. This counter resets when the $V_D < V_{TH-ON}$ event happens more than one time in one switching cycle. When the $\eta_{INV-EXT}$ counter has elapsed, the DLY_EN flag is cleared.

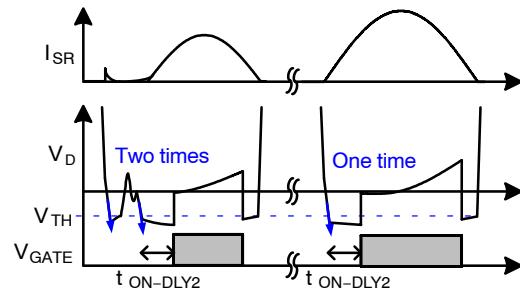

Figure 63. Criterion of Clearing the DLY_EN Flag

For more functional and application-specific topics, please refer to: [AND90154/D – NCP4318 Tips and Tricks](#).

NCP4318

REVISION HISTORY

Revision	Description of Changes	Date
11	Last paragraph with reference to AND90154/D added to Application Information section (p.23).	9/25/2025
12	Figure 1 and Figure 2 replaced with a new version.	3/2/2026

This document has undergone updates prior to the inclusion of this revision history table. The changes tracked here only reflect updates made on the noted approval dates.

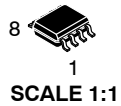

SOIC-8 EP
CASE 751AC
ISSUE E

DATE 05 OCT 2022

NOTES:

1. DIMENSIONING AND TOLERANCING PER ASME Y14.5M, 1994.
2. CONTROLLING DIMENSION: MILLIMETERS
3. DIMENSION b DOES NOT INCLUDE DAMBAR PROTRUSION. ALLOWABLE PROTRUSION SHALL BE 0.004 IN EXCESS OF MAXIMUM MATERIAL CONDITION.
4. DIMENSION D DOES NOT INCLUDE MOLD FLASH, PROTRUSIONS, OR GATE BURRS. MOLD FLASH, PROTRUSIONS, OR GATE BURRS SHALL NOT EXCEED 0.006 PER SIDE. DIMENSION E1 DOES NOT INCLUDE INTERLEAD FLASH OR PROTRUSION. INTERLEAD FLASH OR PROTRUSION SHALL NOT EXCEED 0.010 mm PER SIDE.
5. THE PACKAGE TOP MAY BE SMALLER THAN THE PACKAGE BOTTOM. DIMENSIONS D AND E1 ARE DETERMINED AT THE OUTERMOST EXTREMES OF THE PLASTIC BODY AT DATUM H.
6. DATUMS A AND B ARE TO BE DETERMINED AT DATUM H.
7. DIMENSIONS b AND c APPLY TO THE FLAT SECTION OF THE LEAD BETWEEN 0.10 TO 0.25 FROM THE LEAD TIP.
8. A1 IS DEFINED AS THE VERTICAL DISTANCE FROM THE SEATING PLANE TO THE LOWEST POINT ON THE PACKAGE BODY.

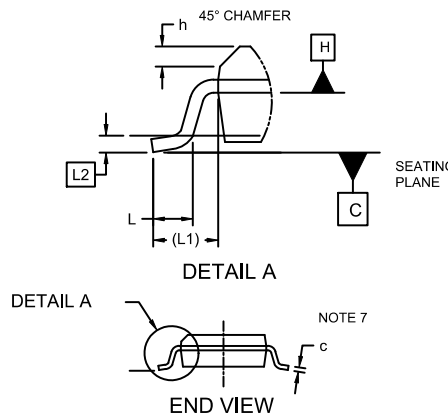
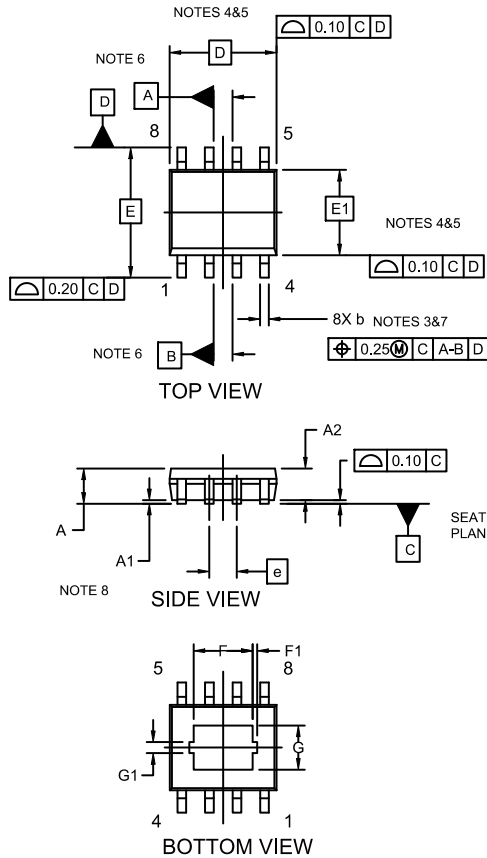

DIM	MILLIMETERS		
	MIN.	NOM..	MAX.
A	1.35	1.55	1.75
A1	---	0.05	0.10
A2	1.35	1.50	1.65
b	0.31	0.41	0.51
c	0.17	0.21	0.23
D	4.90 BSC		
E	6.00 BSC		
E1	3.90 BSC		
e	1.27 BSC		
F	2.24	2.72	3.20
F1	0.20 REF		
G	1.55	2.03	2.51
G1	0.46 REF		
h	0.25	0.38	0.50
L	0.40	0.84	1.27
L1	1.04 REF		
L2	0.25 REF		
∅	0°	4°	8°

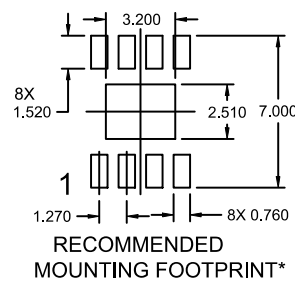

*For additional information on our Pb-Free strategy and soldering details, please download the ON Semiconductor Soldering and Mounting Techniques Reference Manual, SOLDERRM/D."

GENERIC MARKING DIAGRAM*

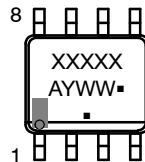

- XXXXXX = Specific Device Code
- A = Assembly Location
- Y = Year
- WW = Work Week
- = Pb-Free Package

*This information is generic. Please refer to device data sheet for actual part marking. Pb-Free indicator, "G" or microdot "■", may or may not be present and may be in either location. Some products may not follow the Generic Marking.

DOCUMENT NUMBER:	98AON14029D	Electronic versions are uncontrolled except when accessed directly from the Document Repository. Printed versions are uncontrolled except when stamped "CONTROLLED COPY" in red.
DESCRIPTION:	SOIC-8 EP	PAGE 1 OF 1

onsemi and ONSEMI are trademarks of Semiconductor Components Industries, LLC dba onsemi or its subsidiaries in the United States and/or other countries. onsemi reserves the right to make changes without further notice to any products herein. onsemi makes no warranty, representation or guarantee regarding the suitability of its products for any particular purpose, nor does onsemi assume any liability arising out of the application or use of any product or circuit, and specifically disclaims any and all liability, including without limitation special, consequential or incidental damages. onsemi does not convey any license under its patent rights nor the rights of others.

SOIC-8, 150 mils
CASE 751BD
ISSUE O

DATE 19 DEC 2008

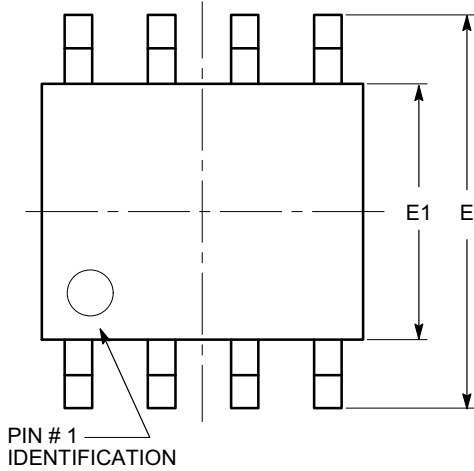

TOP VIEW

SYMBOL	MIN	NOM	MAX
A	1.35		1.75
A1	0.10		0.25
b	0.33		0.51
c	0.19		0.25
D	4.80		5.00
E	5.80		6.20
E1	3.80		4.00
e	1.27 BSC		
h	0.25		0.50
L	0.40		1.27
θ	0°		8°

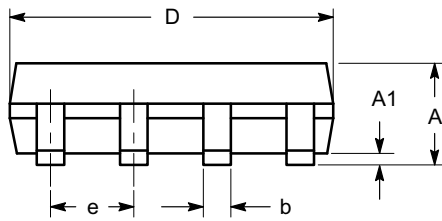

SIDE VIEW

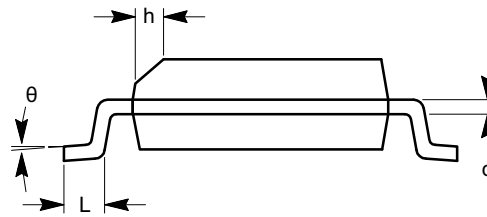

END VIEW

Notes:

- (1) All dimensions are in millimeters. Angles in degrees.
- (2) Complies with JEDEC MS-012.

DOCUMENT NUMBER:	98AON34272E	Electronic versions are uncontrolled except when accessed directly from the Document Repository. Printed versions are uncontrolled except when stamped "CONTROLLED COPY" in red.
DESCRIPTION:	SOIC-8, 150 MILS	PAGE 1 OF 1

onsemi and ONSEMI are trademarks of Semiconductor Components Industries, LLC dba onsemi or its subsidiaries in the United States and/or other countries. onsemi reserves the right to make changes without further notice to any products herein. onsemi makes no warranty, representation or guarantee regarding the suitability of its products for any particular purpose, nor does onsemi assume any liability arising out of the application or use of any product or circuit, and specifically disclaims any and all liability, including without limitation special, consequential or incidental damages. onsemi does not convey any license under its patent rights nor the rights of others.

onsemi, **Onsemi**, and other names, marks, and brands are registered and/or common law trademarks of Semiconductor Components Industries, LLC dba "**onsemi**" or its affiliates and/or subsidiaries in the United States and/or other countries. **onsemi** owns the rights to a number of patents, trademarks, copyrights, trade secrets, and other intellectual property. A listing of **onsemi**'s product/patent coverage may be accessed at www.onsemi.com/site/pdf/Patent-Marking.pdf. **onsemi** reserves the right to make changes at any time to any products or information herein, without notice. The information herein is provided "as-is" and **onsemi** makes no warranty, representation or guarantee regarding the accuracy of the information, product features, availability, functionality, or suitability of its products for any particular purpose, nor does **onsemi** assume any liability arising out of the application or use of any product or circuit, and specifically disclaims any and all liability, including without limitation special, consequential or incidental damages. Buyer is responsible for its products and applications using **onsemi** products, including compliance with all laws, regulations and safety requirements or standards, regardless of any support or applications information provided by **onsemi**. "Typical" parameters which may be provided in **onsemi** data sheets and/or specifications can and do vary in different applications and actual performance may vary over time. All operating parameters, including "Typicals" must be validated for each customer application by customer's technical experts. **onsemi** does not convey any license under any of its intellectual property rights nor the rights of others. **onsemi** products are not designed, intended, or authorized for use as a critical component in life support systems or any FDA Class 3 medical devices or medical devices with a same or similar classification in a foreign jurisdiction or any devices intended for implantation in the human body. Should Buyer purchase or use **onsemi** products for any such unintended or unauthorized application, Buyer shall indemnify and hold **onsemi** and its officers, employees, subsidiaries, affiliates, and distributors harmless against all claims, costs, damages, and expenses, and reasonable attorney fees arising out of, directly or indirectly, any claim of personal injury or death associated with such unintended or unauthorized use, even if such claim alleges that **onsemi** was negligent regarding the design or manufacture of the part. **onsemi** is an Equal Opportunity/Affirmative Action Employer. This literature is subject to all applicable copyright laws and is not for resale in any manner.

ADDITIONAL INFORMATION

TECHNICAL PUBLICATIONS:

Technical Library: www.onsemi.com/design/resources/technical-documentation
onsemi Website: www.onsemi.com

ONLINE SUPPORT: www.onsemi.com/support

For additional information, please contact your local Sales Representative at www.onsemi.com/support/sales