

NCP398

USB Type-C VCONN Overvoltage Protection IC

The NCP398 is an overvoltage protection device. It protects VCONN against overvoltages in applications where VCONN is directly derived from the VBUS supply.

At power up, the integrated power MOSFET is automatically controlled to reduce inrush current. The IC continuously monitors undervoltage, overvoltage and thermal events. In case of overvoltage, a very high speed comparator opens the power MOSFET instantaneously.

The part is enabled through the \overline{EN} pin. A high level on this pin allows forcing off the internal switch and drastically decreases the current consumption of the NCP398 core.

Features

- Over-voltage Protection up to + 28 V
- On-chip Low R_{dson} NMOS Transistors: Typical 200 m Ω
- Over-voltage Lockout (OVLO)
- Shutdown \overline{EN} Input
- Output Discharge Path
- WLCSP4 Package 0.84 x 0.84 mm, 0.4p
- UDFN6 Package 2 x 2 mm, 0.65p
- These Parts are ROHS Devices

Typical Applications

- Type-C USB
- Smartphones
- Tablets

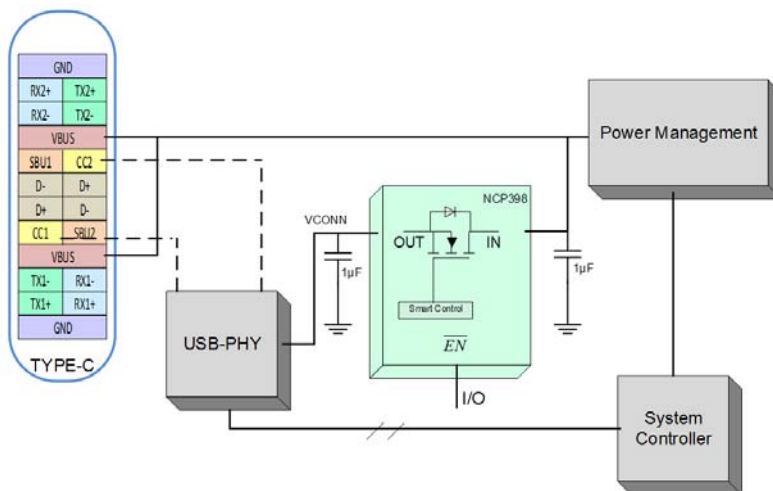

Figure 1. Typical Application Circuit



ON Semiconductor®

www.onsemi.com

MARKING DIAGRAMS



UDFN6
CASE 517AB

AV = Specific Device Code
M = Date Code
▪ = Pb-Free Package

(Note: Microdot may be in either location)

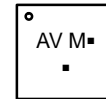

WLCSP4
CASE 567MN

AA = Specific Device Code
A = Assembly Location
Y = Year
W = Work Week

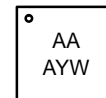

PIN CONNECTIONS

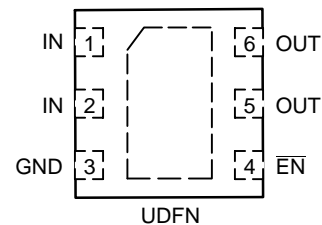

UDFN

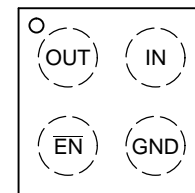

WLCSP

(Top Views)

ORDERING INFORMATION

See detailed ordering and shipping information in the package dimensions section on page 11 of this data sheet.

NCP398

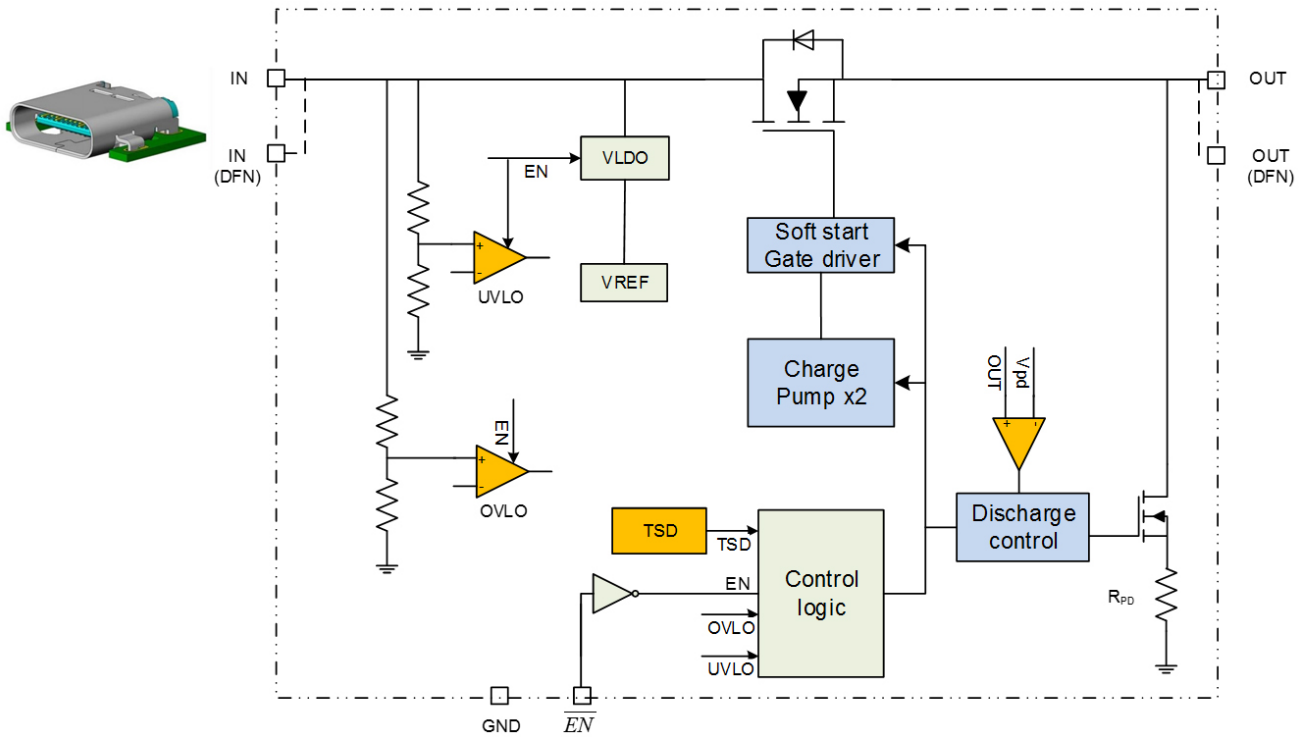

Figure 2. Simplified Block Diagram, WLCSP and UDFN Packages

Table 1. CSP PINOUT DESCRIPTION

Pin	Pin Name	Type	Description
A1	OUT	OUTPUT	Output voltage pin. The OUT pin must be connected to the circuitry that is to be protected (VCONN rail).
B1	\overline{EN}	I/O	Enable pin bar. The device enters in shutdown mode when this pin is tied high in which case the output is disconnected from the input.
A2	IN	POWER	Input voltage pin. The IN pin must be connected to the input power supply (VBUS).
B2	GND	POWER	Ground. Must be connected to the system GND plane.

Table 2. DFN PINOUT DESCRIPTION

Pin	Pin Name	Type	Description
1,2	IN	POWER	Input voltage pins. The two IN pins must be hardwired together and are connected to the input power supply (VBUS).
3	GND	POWER	Ground. Must be connected to the system GND plane.
5,6	OUT	POWER	Output voltage pins. The two OUT pins must be hardwired together and are connected to the circuitry that is to be protected (VCONN rail).
4	\overline{EN}	I/O	Enable pin bar. The device enters in shutdown mode when this pin is tied high in which case the output is disconnected from the input.
7	PAD	POWER	DFN package back side pad. Must be connected to ground plane for thermal dissipation optimization.

NCP398

Table 3. MAXIMUM RATINGS

Rating	Symbol	Value	Unit
Minimum Voltage (All to GND)	V_{MIN}	-0.3	V
Maximum Voltage (Ins to GND)	V_{INMAX}	29	V
Maximum Voltage (All others to GND)	V_{MAX}	7	V
Maximum DC current	I_{MAX}	0.8	A
Thermal Resistance, Junction to Air	$R_{\theta JA}$	WLCSP (Note 1)	170
		DFN (Note 1)	145
Operating Ambient Temperature Range	T_A	-40 to +85	°C
Storage Temperature Range	T_{STG}	-65 to +150	°C
Junction Operating temperature	T_J	+125	°C
Human Body Model (HBM) ESD Rating are (Note 2)	ESD HBM	2	kV
Charged Device Model (CDM) ESD Rating are (Note 2)	ESD CDM	1	kV
Latch Up Current (Note 3)	I_{LU}	100	mA
Moisture Sensitivity	MSL	Level 1	

Stresses exceeding those listed in the Maximum Ratings table may damage the device. If any of these limits are exceeded, device functionality should not be assumed, damage may occur and reliability may be affected.

1. The $R_{\theta JA}$ is highly dependent on the PCB heat sink area. As example UDFN6 $R_{\theta JA}$ is 220°C/W with 50 mm² (copper 35 μm, 1 oz) and 145°C/W with 200 mm² (copper 35 μm, 2 oz).
2. Human Body Model, 100 pF discharged through a 1.5 kΩ resistor following specification JESD22/A114, Charged Device Model (CDM) per JEDEC standard: JESD22-C101 Class IV.
3. Latch Up Current per JEDEC standard: JESD78 class II.

NCP398

Table 4. ELECTRICAL CHARACTERISTICS

Min / Max limits values ($-40^{\circ}\text{C} < T_A < +85^{\circ}\text{C}$) and $V_{IN} = +5\text{ V}$ (Unless otherwise noted). Typical values are $T_A = +25^{\circ}\text{C}$.

Characteristics	Symbols	Conditions	Min	Typ	Max	Unit
Input Voltage Range	V_{IN}		–	–	28	V
Under Voltage Lockout	UVLO	Vin rising	2.4	–	2.8	V
Under Voltage Lockout Hysteresis	UVLO _{HYST}	Vin falling	–	50	–	mV
Over voltage Lockout Threshold	OVLO (Note 4)	Vin rising	5.50	5.65	5.80	V
Over voltage Lockout Threshold hysteresis	OVLO _{HYST}	Vin falling	–	115	–	mV
Vin versus Vout Resistance	R _{DS(on)}	Vin = 5 V, \overline{EN} = low, 25°C, WLCSP	–	190	220	mΩ
		–40°C < T _J < 85°C, WLCSP	–	230	260	
		Vin = 5 V, \overline{EN} = low, 25°C, UDFN	–	230	260	
		–40°C < T _J < 85°C, UDFN	–	270	300	
Supply Quiescent Current	I _{DD}	No load. \overline{EN} = low	–	40	60	μA
OFF current	I _{OFF}	\overline{EN} = high	–	–	1.5	μA
Standby current	I _{STB}	Vin = 2.4 V	–	–	2.5	μA
Output Discharge path	R _{PD}	From \overline{EN} = low to high or Vin < UVLO – hysteresis to Vout = V _{PD}	8	10	12	kΩ
Output Discharge path level	V _{PD}	Vout falling	–	0.63	–	V

EN

\overline{EN} Voltage High	V _{IH}		1.2	–	–	V
\overline{EN} Voltage Low	V _{IL}		–	–	0.4	V
\overline{EN} Input Leakage Current	I _{EN}	0 < V _{EN} < 5.5 V	–1	0	+1	μA

TIMINGS

Ton Time	T _{ON}	Vin valid, From \overline{EN} high to low, 90% Vout	–	0.3	1	ms
Disable Time	T _{OFF}	From \overline{EN} low to high, to 90% Vout. R _{LOAD} 100 Ω	–	10	–	μs
OVLO Turn Off Time	T _{OVLO}	Vin exceeding V _{OVLO} at 2 V/μs to Vout starts decreasing. R _{LOAD} 100 Ω	–	100	–	ns

TSD

Thermal shutdown	TSD		–	150	–	°C
Thermal shutdown rearming	TSD rearm		–	125	–	°C

4. Please contact your ON representative for additional OVLO thresholds.
Product parametric performance is indicated in the Electrical Characteristics for the listed test conditions, unless otherwise noted. Product performance may not be indicated by the Electrical Characteristics if operated under different conditions.

Operation

The NCP398 device provides overvoltage protection when a wrong input supply is connected or voltage ringing appears on the input line. The internal NMOS Fet is soft start controlled to limit inrush current into the load (capacitors, IC wake up).

The device integrates an enable control pin, undervoltage and overvoltage comparators, and output discharge path to eliminate residual voltage after the turn off.

Timings Chronogram and States Description

The phase 1 sections described below are respectively the OFF state (\overline{EN} high) and the standby state ($V_{IN} <$

$UVLO$) of the device. When V_{in} is below the undervoltage comparator (UVLO) or \overline{EN} is tied high, NCP398 will be in this state.

Phase 2 corresponds to the defined time for the gate driver soft start. Referring to the electrical parameter, this phase is aligned to t_{ON} time.

Phase 3 is the normal operation, with V_{in} valid, the part enabled and there is no fault.

The behavior during an overvoltage condition is detailed in the phase number 4.

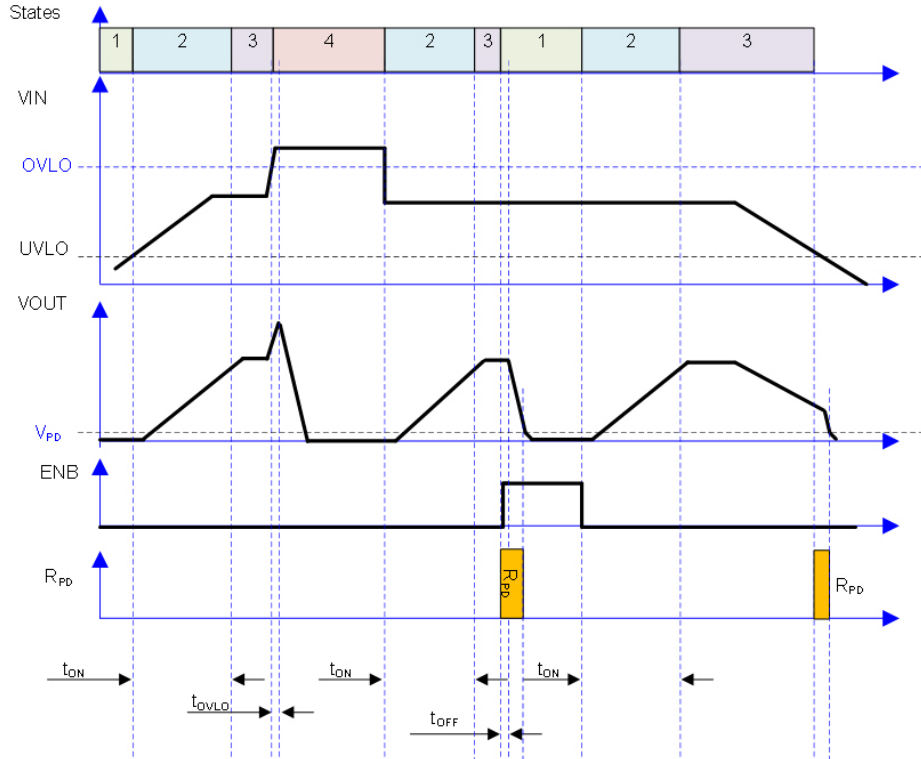

Figure 3. Timings Diagram

Enable Bar Pin (\overline{EN})

The part is enabled through the \overline{EN} pin. In some diagrams and figures, ENB refers to \overline{EN} . A high level on this pin allows forcing off the internal switch and drastically decreases the current consumption of the NCP398 core. To exit the OFF state, the \overline{EN} pin must be tied low.

Under-voltage Lockout (UVLO)

To ensure proper operation under any conditions, the device integrates an under-voltage lock out (UVLO) comparator. This block has a built-in hysteresis to provide noise immunity to transient conditions.

Over-voltage Lockout (OVLO)

To protect connected systems on V_{OUT} pin from over-voltage, a second comparator, over-voltage lock out (OVLO), is embedded. During over-voltage condition, the output remains disabled until the input voltage drops below the OVLO – comparator hysteresis.

Auto Discharge – R_{pd}

When disabling the NCP398 the output gets automatically discharged by means of the internal pull down resistor R_{pd} . Once reaching the V_{pd} level the discharge path is disabled. The auto-discharge is also engaged when V_{in} drops below the UVLO threshold. The auto-discharge ensures a proper power cycling of peripherals connected to the output of the NCP398.

Thermal Shutdown Protection

In case of internal overheating, the integrated thermal shutdown (TSD) protection will open the internal NMOS FET in order to instantaneously decrease the device temperature.

Embedded hysteresis allows reengaging the NMOS FET when the junction temperature decreases.

This OFF-ON cycle is repeated until the fault event disappears.

TYPICAL CHARACTERISTICS

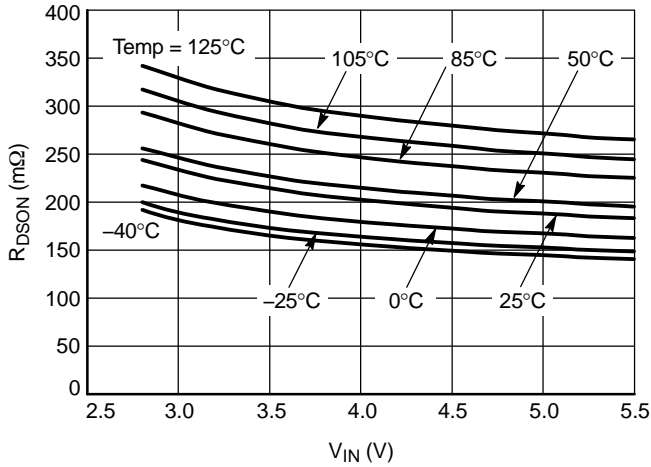

Figure 4. Ron vs. Vin, Overtemperature

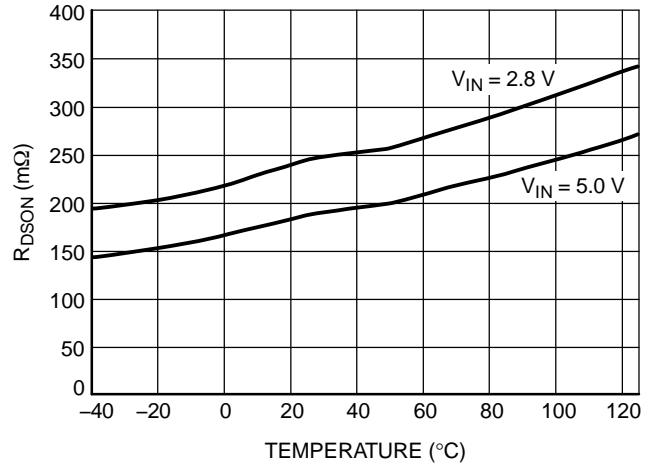

Figure 5. Ron vs. Temperature, at Fixed Vin Voltage

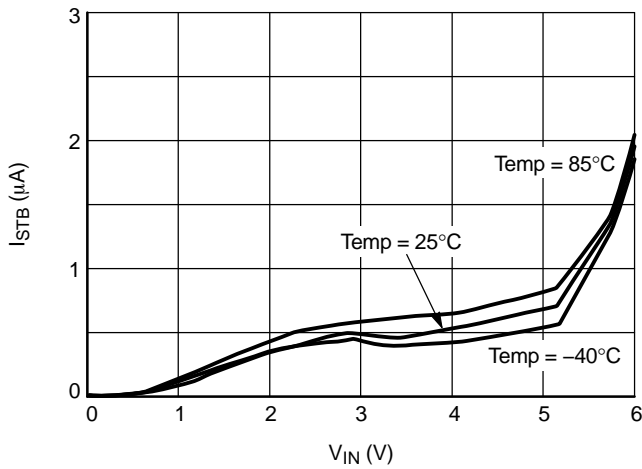

Figure 6. Standby Current vs. Vin, Over Temperature

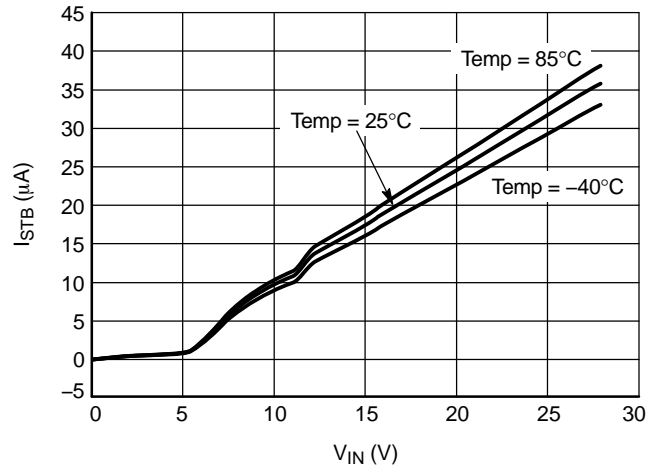

Figure 7. Standby Current vs. Vin, Over Temperature

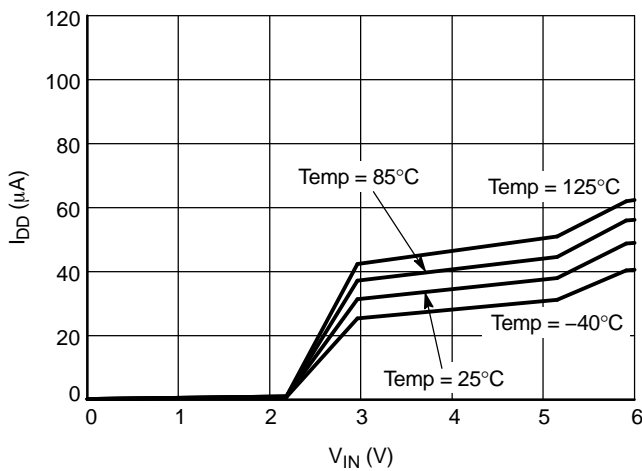

Figure 8. Quiescent Current vs. Vin, Over Temperature

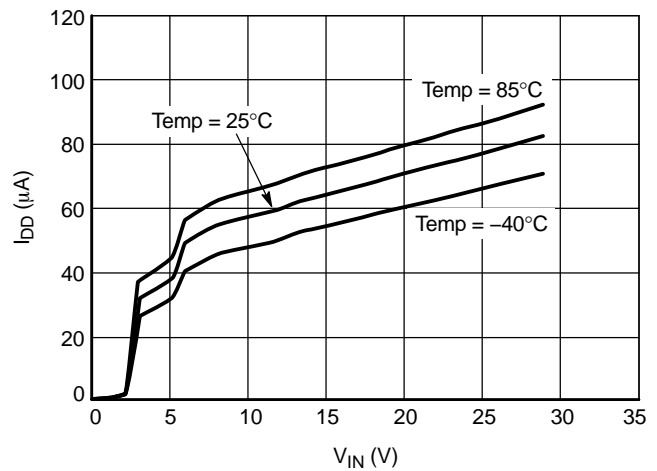

Figure 9. Quiescent Current vs. Vin, Over Temperature

NCP398

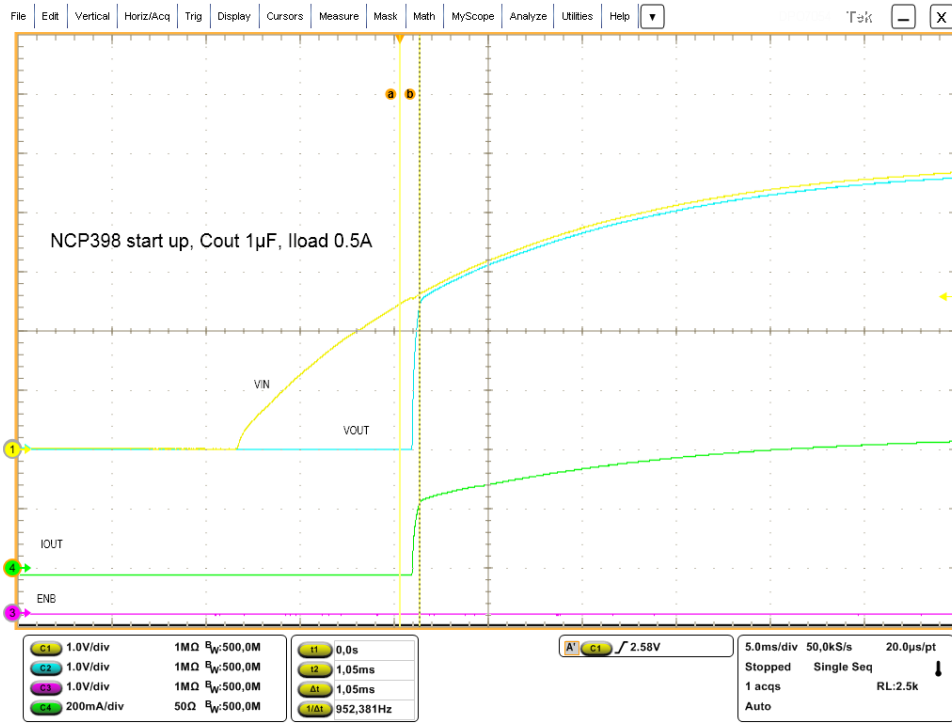

Figure 10. Soft Start Up On Load, Vin: yellow, Vout: blue, \overline{EN} : pink, IOUT: green

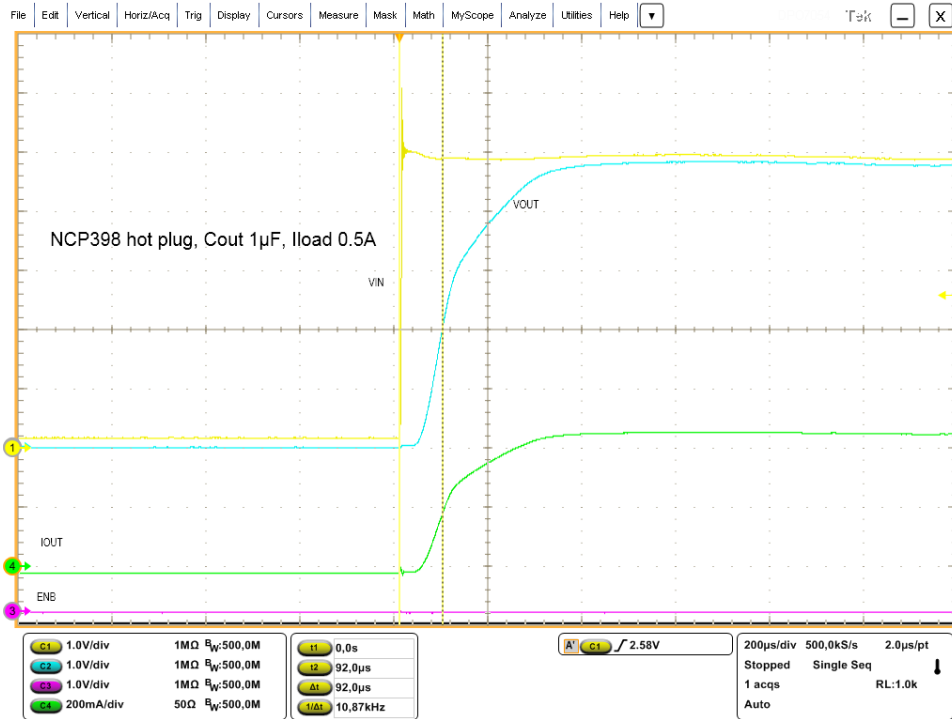

Figure 11. Hot Plug On Load, Vin: yellow, Vout: blue, \overline{EN} : pink, IOUT: green

NCP398

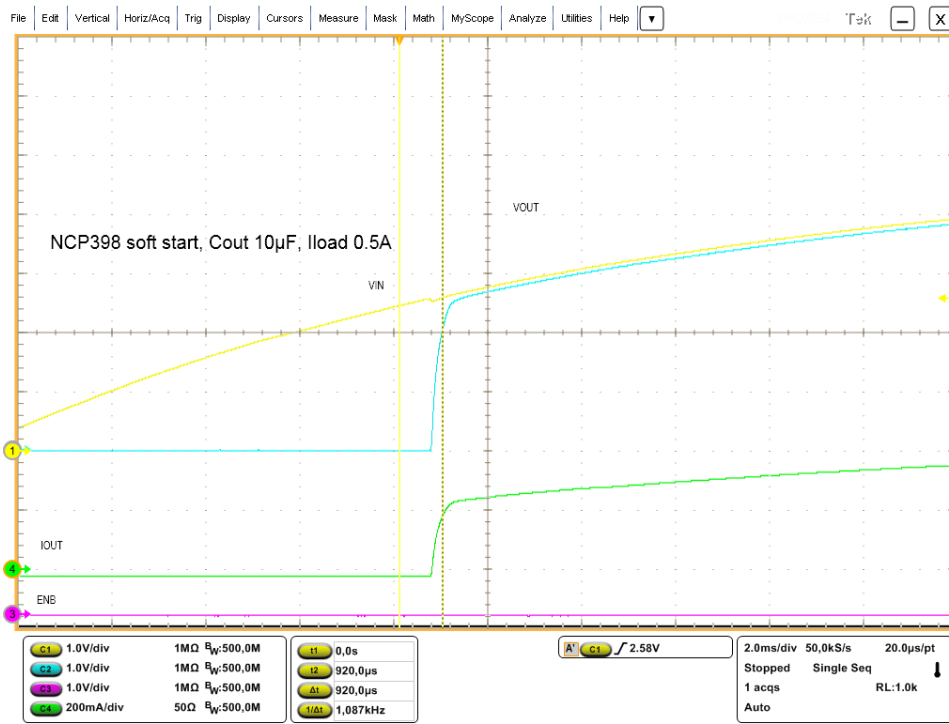

Figure 12. Soft Start On Cout 10 µF, 500 mA, Vin: yellow, Vout: blue, EN: pink, IOUT: green

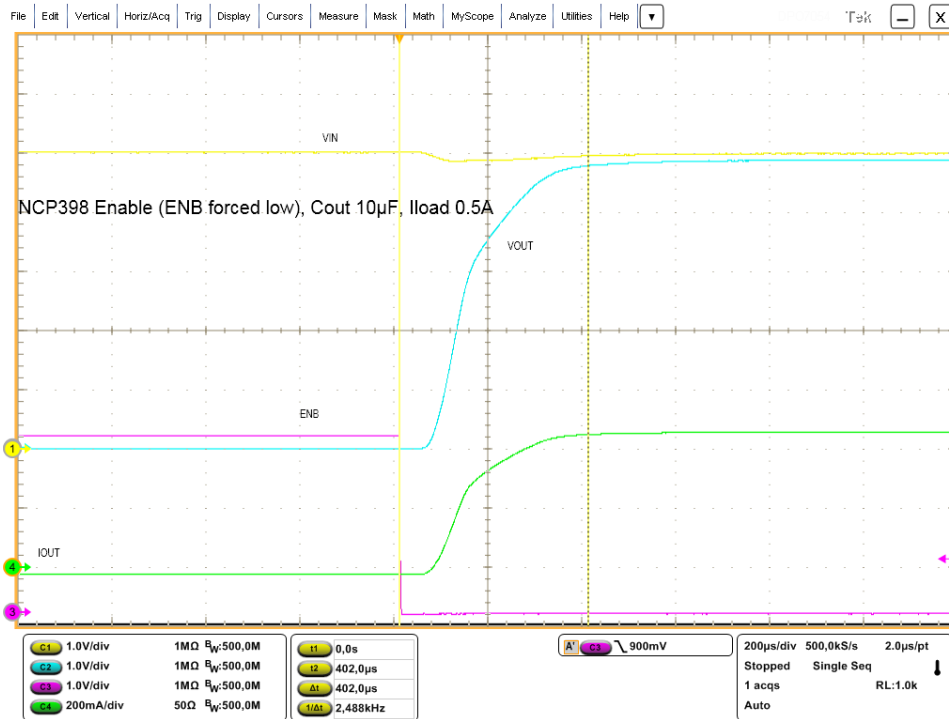

Figure 13. NCP398 Enable (ENB forced low) Vin: yellow, Vout: blue, EN: pink, IOUT: green

NCP398

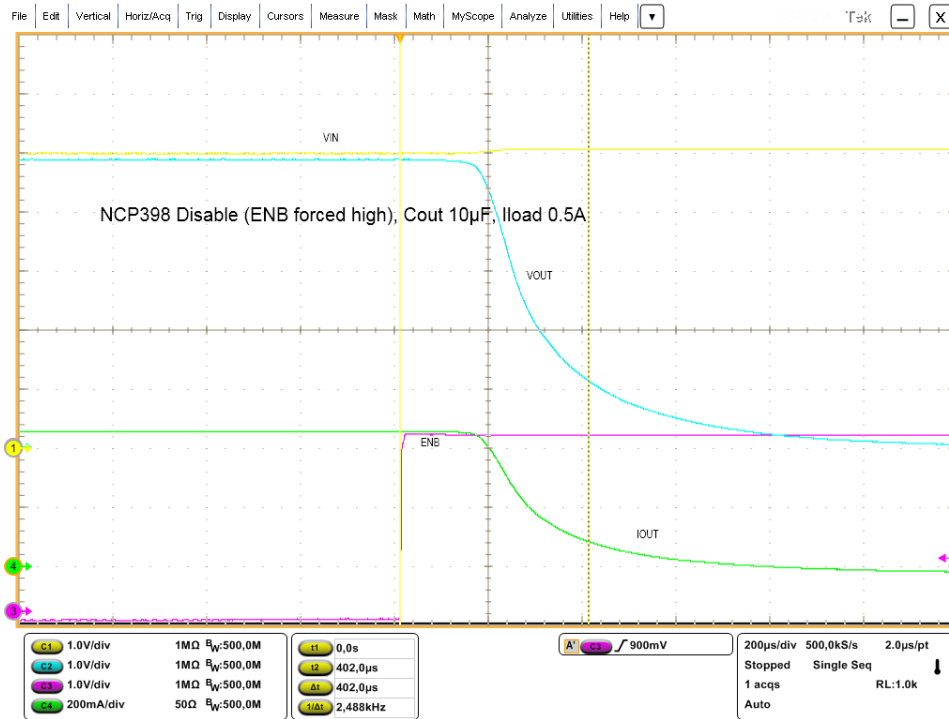

Figure 14. NCP398 Disable (ENB forced high) Vin: yellow, Vout: blue, $\overline{\text{EN}}$: pink, IOUT: green

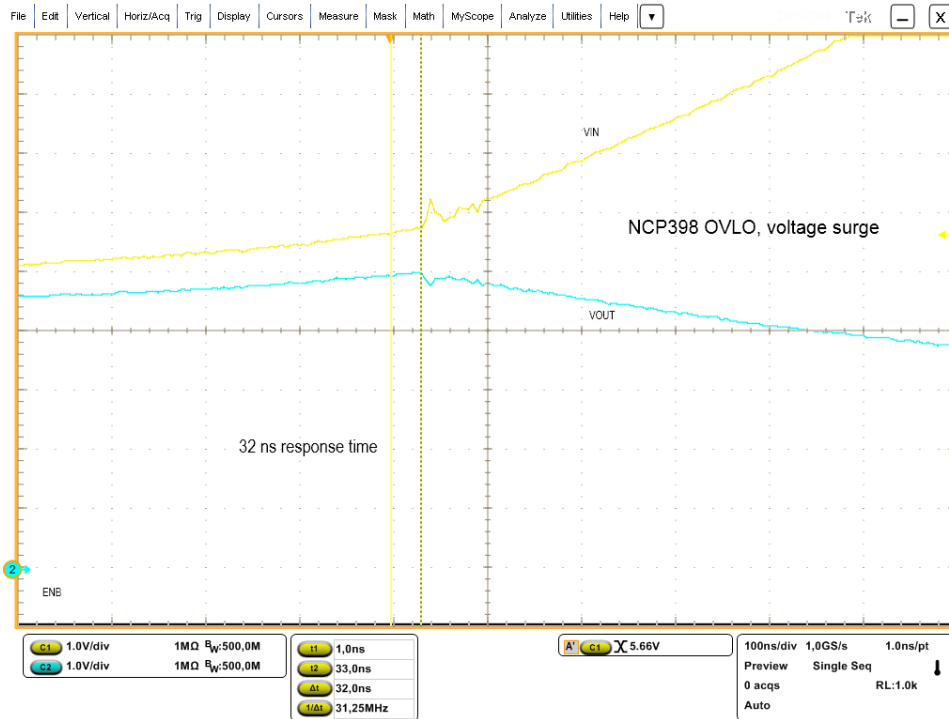

Figure 15. NCP398 OVL0 Time Response, Vin: yellow, Vout: blue

NCP398

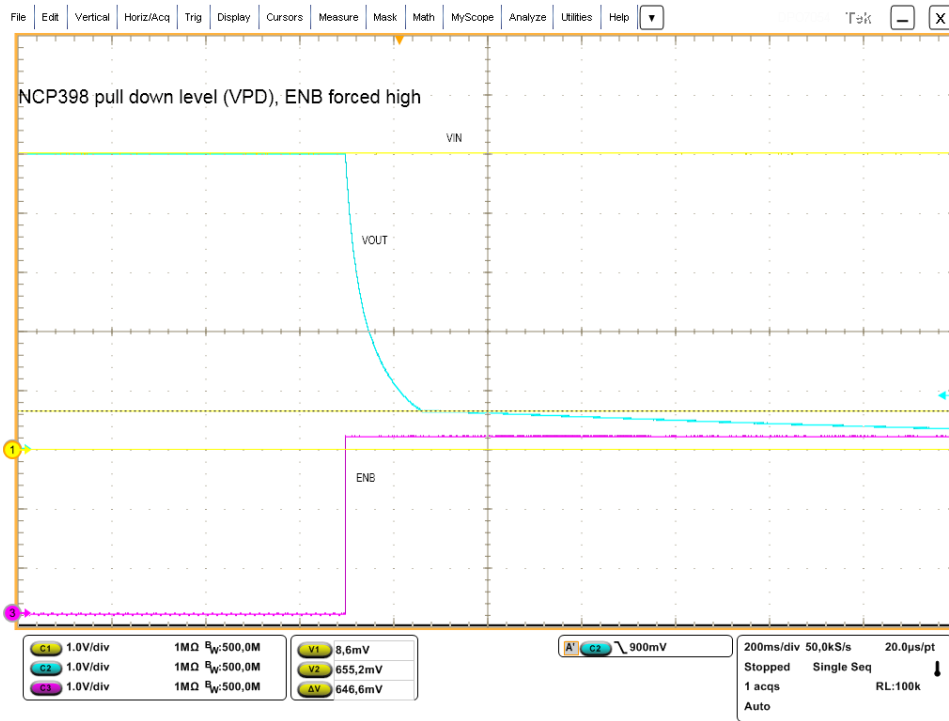

Figure 16. NCP398 Pull Down Level (following disable) Vin: yellow, Vout: blue, \overline{EN} : pink

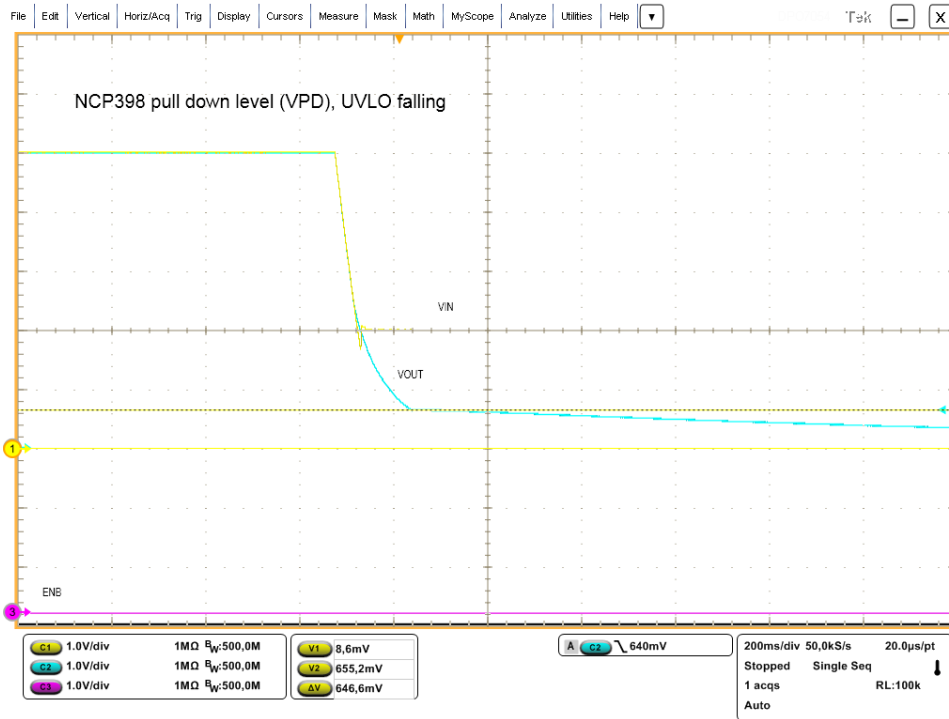

Figure 17. NCP398 Pull Down Level (following UVLO) Vin: yellow, Vout: blue, \overline{EN} : pink

NCP398

ORDERING INFORMATION

Device	Marking	Package	Shipping†
NCP398FCCT1G	AA	WLCSP4 0.84x0.84 mm	3000 Tape / Reel
NCP398MUTBG	AV	UDFN6 2x2 mm	3000 Tape / Reel

†For information on tape and reel specifications, including part orientation and tape sizes, please refer to our Tape and Reel Packaging Specifications Brochure, BRD8011/D.

MECHANICAL CASE OUTLINE

PACKAGE DIMENSIONS

ON Semiconductor®



SCALE 4:1

UDFN6 2x2, 0.65P
CASE 517AB
ISSUE C

DATE 10 APR 2013

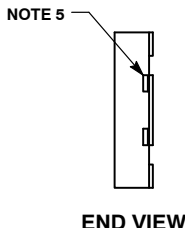
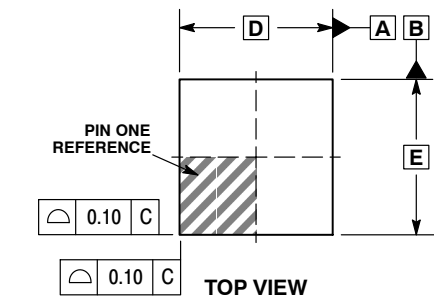

- NOTES:
1. DIMENSIONING AND TOLERANCING PER ASME Y14.5M, 1994.
 2. CONTROLLING DIMENSION: MILLIMETERS.
 3. DIMENSION b APPLIES TO PLATED TERMINAL AND IS MEASURED BETWEEN 0.15 AND 0.25MM FROM THE TERMINAL TIP.
 4. COPLANARITY APPLIES TO THE EXPOSED PAD AS WELL AS THE TERMINALS.
 5. TIE BARS MAY BE VISIBLE IN THIS VIEW AND ARE CONNECTED TO THE THERMAL PAD.

DIM	MILLIMETERS	
	MIN	MAX
A	0.45	0.55
A1	0.00	0.05
A3	0.127 REF	
b	0.25	0.35
D	2.00 BSC	
D2	1.50	1.70
E	2.00 BSC	
E2	0.80	1.00
e	0.65 BSC	
L	0.25	0.35
L1	---	0.15

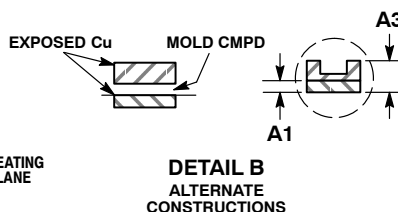
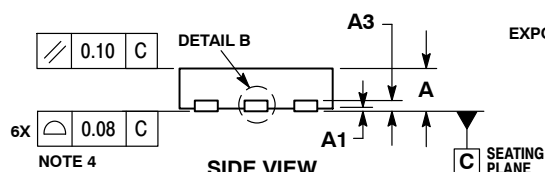

GENERIC MARKING DIAGRAM*



- XX = Specific Device Code
- M = Date Code
- = Pb-Free Package

(Note: Microdot may be in either location)

*This information is generic. Please refer to device data sheet for actual part marking. Pb-Free indicator, "G" or microdot "▪", may or may not be present.

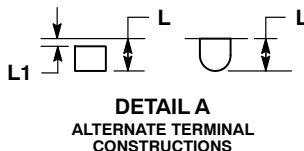
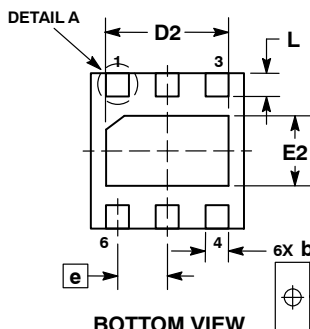

RECOMMENDED SOLDERING FOOTPRINT*

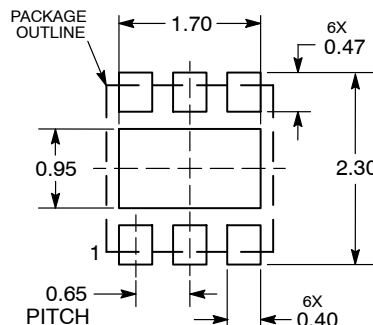

DIMENSIONS: MILLIMETERS

*For additional information on our Pb-Free strategy and soldering details, please download the ON Semiconductor Soldering and Mounting Techniques Reference Manual, SOLDERRM/D.

DOCUMENT NUMBER:	98AON22162D	Electronic versions are uncontrolled except when accessed directly from the Document Repository. Printed versions are uncontrolled except when stamped "CONTROLLED COPY" in red.
DESCRIPTION:	UDFN6 2X2, 0.65P	PAGE 1 OF 1

ON Semiconductor and ON are trademarks of Semiconductor Components Industries, LLC dba ON Semiconductor or its subsidiaries in the United States and/or other countries. ON Semiconductor reserves the right to make changes without further notice to any products herein. ON Semiconductor makes no warranty, representation or guarantee regarding the suitability of its products for any particular purpose, nor does ON Semiconductor assume any liability arising out of the application or use of any product or circuit, and specifically disclaims any and all liability, including without limitation special, consequential or incidental damages. ON Semiconductor does not convey any license under its patent rights nor the rights of others.

MECHANICAL CASE OUTLINE

PACKAGE DIMENSIONS

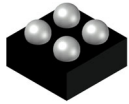

WLCSP4, 0.84x0.84x0.554
CASE 567MN
ISSUE B

DATE 14 JUN 2022

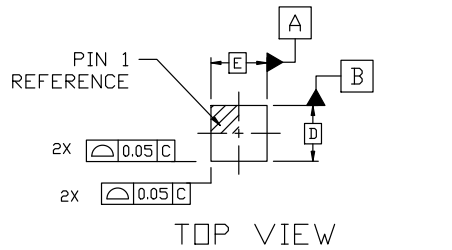

TOP VIEW

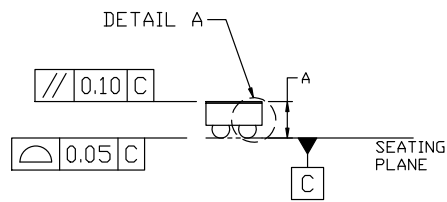

SIDE VIEW

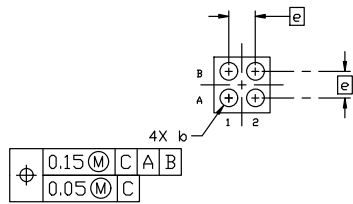

BOTTOM VIEW

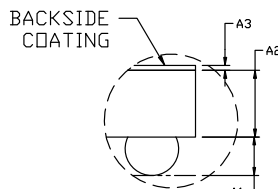

DETAIL A
 SCALE 1:3

NOTES:

1. DIMENSIONING AND TOLERANCING PER ASME Y14.5M, 2009.
2. CONTROLLING DIMENSION: MILLIMETERS
3. DIMENSION b IS MEASURED AT THE MAXIMUM SOLDER BALL DIAMETER PARALLEL TO DATUM C.
4. COPLANARITY APPLIES TO THE SPHERICAL CROWNS OF THE SOLDER BALLS.
5. DATUM C, THE SEATING PLANE, IS DEFINED BY THE SPHERICAL CROWNS OF THE SOLDER BALLS.

DIM	MILLIMETERS		
	MIN.	NOM.	MAX.
A	0.509	0.554	0.599
A1	0.174	0.194	0.214
A2	0.310	0.335	0.360
A3	0.025 BSC		
b	0.239	0.269	0.299
D	0.84 BSC		
E	0.84 BSC		
e	0.40 BSC		

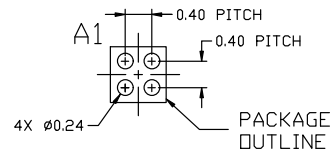

RECOMMENDED
 MOUNTING FOOTPRINT*

* For additional information on our Pb-Free strategy and soldering details, please download the ON Semiconductor Soldering and Mounting Techniques Reference Manual, SOLDERRM/D.

GENERIC MARKING DIAGRAM*

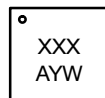

A = Assembly Location
 Y = Year
 W = Work Week

*This information is generic. Please refer to device data sheet for actual part marking. Pb-Free indicator, "G" or microdot "μ", may or may not be present. Some products may not follow the Generic Marking.

DOCUMENT NUMBER:	98AON05454G	Electronic versions are uncontrolled except when accessed directly from the Document Repository. Printed versions are uncontrolled except when stamped "CONTROLLED COPY" in red.
DESCRIPTION:	WLCSP4, 0.84X0.84X0.554	PAGE 1 OF 1

onsemi and ONSEMI are trademarks of Semiconductor Components Industries, LLC dba onsemi or its subsidiaries in the United States and/or other countries. onsemi reserves the right to make changes without further notice to any products herein. onsemi makes no warranty, representation or guarantee regarding the suitability of its products for any particular purpose, nor does onsemi assume any liability arising out of the application or use of any product or circuit, and specifically disclaims any and all liability, including without limitation special, consequential or incidental damages. onsemi does not convey any license under its patent rights nor the rights of others.

onsemi, **Onsemi**, and other names, marks, and brands are registered and/or common law trademarks of Semiconductor Components Industries, LLC dba "**onsemi**" or its affiliates and/or subsidiaries in the United States and/or other countries. **onsemi** owns the rights to a number of patents, trademarks, copyrights, trade secrets, and other intellectual property. A listing of **onsemi**'s product/patent coverage may be accessed at www.onsemi.com/site/pdf/Patent-Marking.pdf. **onsemi** reserves the right to make changes at any time to any products or information herein, without notice. The information herein is provided "as-is" and **onsemi** makes no warranty, representation or guarantee regarding the accuracy of the information, product features, availability, functionality, or suitability of its products for any particular purpose, nor does **onsemi** assume any liability arising out of the application or use of any product or circuit, and specifically disclaims any and all liability, including without limitation special, consequential or incidental damages. Buyer is responsible for its products and applications using **onsemi** products, including compliance with all laws, regulations and safety requirements or standards, regardless of any support or applications information provided by **onsemi**. "Typical" parameters which may be provided in **onsemi** data sheets and/or specifications can and do vary in different applications and actual performance may vary over time. All operating parameters, including "Typicals" must be validated for each customer application by customer's technical experts. **onsemi** does not convey any license under any of its intellectual property rights nor the rights of others. **onsemi** products are not designed, intended, or authorized for use as a critical component in life support systems or any FDA Class 3 medical devices or medical devices with a same or similar classification in a foreign jurisdiction or any devices intended for implantation in the human body. Should Buyer purchase or use **onsemi** products for any such unintended or unauthorized application, Buyer shall indemnify and hold **onsemi** and its officers, employees, subsidiaries, affiliates, and distributors harmless against all claims, costs, damages, and expenses, and reasonable attorney fees arising out of, directly or indirectly, any claim of personal injury or death associated with such unintended or unauthorized use, even if such claim alleges that **onsemi** was negligent regarding the design or manufacture of the part. **onsemi** is an Equal Opportunity/Affirmative Action Employer. This literature is subject to all applicable copyright laws and is not for resale in any manner.

ADDITIONAL INFORMATION

TECHNICAL PUBLICATIONS:

Technical Library: www.onsemi.com/design/resources/technical-documentation
onsemi Website: www.onsemi.com

ONLINE SUPPORT: www.onsemi.com/support

For additional information, please contact your local Sales Representative at www.onsemi.com/support/sales

