

Soft-Start Controlled Load Switch

NCP340

The NCP340 is a low $R_{DS(on)}$ N-channel MOSFET controlled by a soft-start sequence of 2 ms for mobile applications.

The very low $R_{DS(on)}$ allows system supplying or battery charging up to DC 3A. The device is enable automatically if a Power Supply is connected on Vin pin (active High) and maintained off if no Vin (internal pull down).

Due to a current consumption optimization, leakage current is drastically decreased from the battery connected to the device, allowing long battery life.

Features

- 1.8 V – 5.5 V Operating Range
- 30 mΩ N-MOSFET
- DC Current Up to 3 A
- Built-in Soft-Start 2 ms
- Reverse Voltage Protection
- Active High with Integrated Bridge
- Compliance to IEC61000-4-2 (Level 4)
8.0 kV (Contact)
15 kV (Air)
- ESD Ratings: Machine Model = B
Human Body Model = 3
- μDFN4 1.2 x 1.6 mm
- This is a Pb-Free Device

Typical Applications

- Mobile Phones
- Tablets
- Digital Cameras
- GPS
- Computers

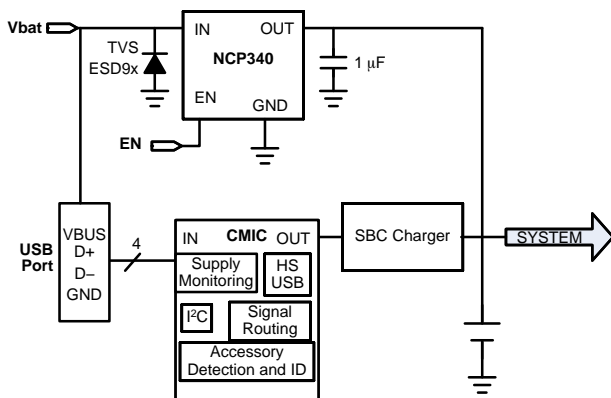

Figure 1. Typical Application Circuit



UDFN4
CASE 517CE

MARKING DIAGRAM



34 = Specific Device Code
M = Date Code

PINOUT

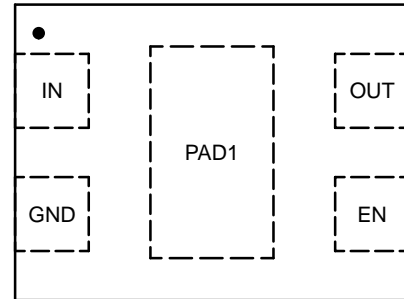

(Top View)

ORDERING INFORMATION

See detailed ordering and shipping information on page 8 of this data sheet.

NCP340

PIN FUNCTION DESCRIPTION

Pin Name	Pin Number	Type	Description
IN	1	POWER	Power-switch input voltage; connect a 1 μ F or greater ceramic capacitor from IN to GND as close as possible to the IC.
GND	2	POWER	Ground connection;
EN	3	INPUT	Enable input, logic high turns on power switch.
OUT	4	OUTPUT	Power-switch output; connect a 1 μ F ceramic capacitor from OUT to GND as close as possible to the IC is recommended.
PAD1		POWER	Exposed pad can be connected to GND plane for dissipation purpose or any other thermal plane.

BLOCK DIAGRAM

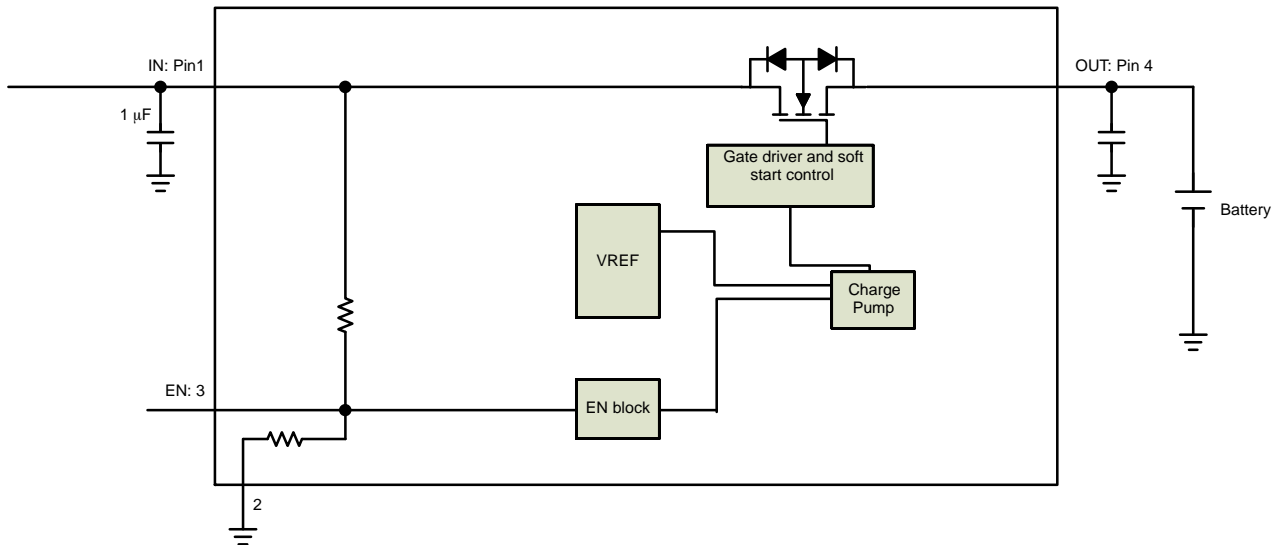

Figure 2. Block Diagram

NCP340

MAXIMUM RATINGS

Rating	Symbol	Value	Unit
IN, OUT, EN, Pins:	V_{EN}, V_{IN}, V_{OUT}	-0.3 to + 7.0	V
From IN to OUT Pins: Input/Output	V_{IN}, V_{OUT}	-7.0 to + 7.0	V
ESD Withstand Voltage (IEC 61000-4-2) (Note 1) (IN and OUT when bypassed with 1.0 μ F capacitor minimum)	ESD IEC	15 Air, 8 contact	kV
Human Body Model (HBM) ESD Rating are (Notes 2 and 3)	ESD HBM	8000	V
Machine Model (MM) ESD Rating are (Notes 2 and 3)	ESD MM	250	V
Latch-up protection (Note 4) – Pins IN, OUT, EN	LU	100	mA
Maximum Junction Temperature Range	T_J	-40 to + 125	$^{\circ}$ C
Storage Temperature Range	T_{STG}	-40 to + 150	$^{\circ}$ C
Moisture Sensitivity (Note 5)	MSL	Level 1	

Stresses exceeding those listed in the Maximum Ratings table may damage the device. If any of these limits are exceeded, device functionality should not be assumed, damage may occur and reliability may be affected.

1. Guaranteed by design.
2. According to JEDEC standard JESD22-A108.
3. This device series contains ESD protection and passes the following tests:
Human Body Model (HBM) ± 2.0 kV per JEDEC standard: JESD22-A114 for all pins.
Machine Model (MM) ± 200 V per JEDEC standard: JESD22-A115 for all pins.
4. Latch up Current Maximum Rating: ± 100 mA per JEDEC standard: JESD78 class II.
5. Moisture Sensitivity Level (MSL): 1 per IPC/JEDEC standard: J-STD-020.

OPERATING CONDITIONS

Symbol	Parameter	Conditions	Min	Typ	Max	Unit
V_{IN}	Operational Power Supply		1.8		5.5	V
V_{EN}	Enable Voltage		0		5.5	
T_A	Ambient Temperature Range		- 40	25	+ 85	$^{\circ}$ C
T_J	Junction Temperature Range		- 40	25	+ 125	$^{\circ}$ C
C_{IN}	Decoupling input capacitor		1			μ F
C_{OUT}	Decoupling output capacitor	USB port per Hub	1			μ F
$R_{\theta JA}$	Thermal Resistance Junction to Air	UDFN4 package (Note 6)		170		$^{\circ}$ C/W
I_{OUT}	Maximum DC current	UDFN4 package			3	A
I_{peak}	Maximum Peak current	100 μ s pulse			15	A
P_D	Power Dissipation Rating (Note 7)	$T_A \leq 25$ $^{\circ}$ C	UDFN4 package		0.58	W
		$T_A = 85$ $^{\circ}$ C	UDFN4 package		0.225	

6. The $R_{\theta JA}$ is dependent of the PCB heat dissipation.
7. The maximum power dissipation (P_D) is given by the following formula:

$$P_D = \frac{T_{JMAX} - T_A}{R_{\theta JA}}$$

NCP340

ELECTRICAL CHARACTERISTICS Min & Max Limits apply for T_A between $-40\text{ }^\circ\text{C}$ to $+85\text{ }^\circ\text{C}$ and T_J up to $+125\text{ }^\circ\text{C}$ for V_{IN} between 1.8 V to 5.5 V (Unless otherwise noted). Typical values are referenced to $T_A = +25\text{ }^\circ\text{C}$ and $V_{IN} = 5\text{ V}$.

Symbol	Parameter	Conditions	Min	Typ	Max	Unit
--------	-----------	------------	-----	-----	-----	------

POWER SWITCH

$R_{DS(on)}$	Static drain-source on-state resistance	$V_{IN} = 3\text{ V},$ $V_{IN} = 5\text{ V}$	$T_J = 25\text{ }^\circ\text{C}$		26		m Ω
			$-40\text{ }^\circ\text{C} < T_J < 125\text{ }^\circ\text{C}$			50	
T_R	Output rise time	$V_{IN} = 5\text{ V}$	$C_{LOAD} = 1\text{ }\mu\text{F},$ $R_{LOAD} = 125\text{ }\Omega$ (Note 8)	0.5	2	4	ms
T_F	Output fall time	$V_{IN} = 5\text{ V}$	$C_{LOAD} = 100\text{ }\mu\text{F},$ $R_{LOAD} = 40\text{ }\Omega$ (Note 8)		4		ms
T_{on}	Gate turn on	$V_{IN} = 5\text{ V}$	From V_{in} applied to $V_{OUT} = 10\%$ of fully on	0.5	2	4	ms
		$V_{IN} = 3\text{ V}$	From V_{in} applied to $V_{OUT} = 10\%$ of fully on (Note 9)			3	

ENABLE INPUT EN

V_{IH}	High-level input voltage		1.15			V
V_{IL}	Low-level input voltage				0.85	V
R_{pd}	En pull-down resistor			1		M Ω
R_{pu}	En pull-up resistor			1.5		M Ω

REVERSE-LEAKAGE PROTECTION

I_{REV}	Reverse-current protection	$V_{IN} = 0\text{ V}, V_{out} = 4.2\text{ V}$ (part disable), $T_J = 25\text{ }^\circ\text{C}$		0.15	1	μA
-----------	----------------------------	--	--	------	---	---------------

QUIESCENT CURRENT

I_q	Current consumption	No load		100	200	μA
-------	---------------------	---------	--	-----	-----	---------------

8. Parameters are guaranteed for C_{LOAD} and R_{LOAD} connected to the OUT pin with respect to the ground.

9. Guaranteed by characterization.

NCP340

TYPICAL CHARACTERISTICS

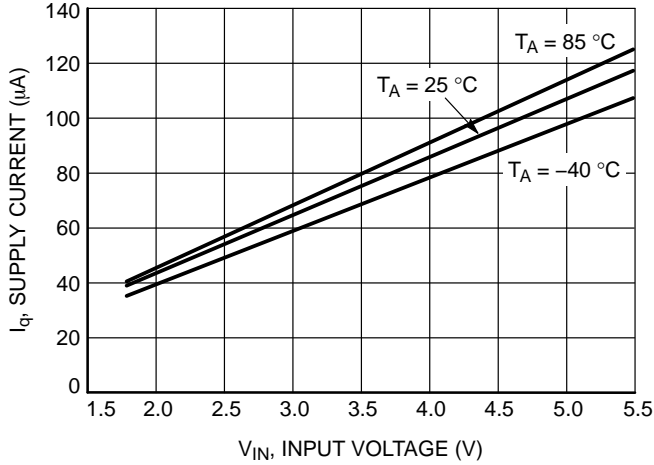

Figure 3. Supply Current vs. Voltage

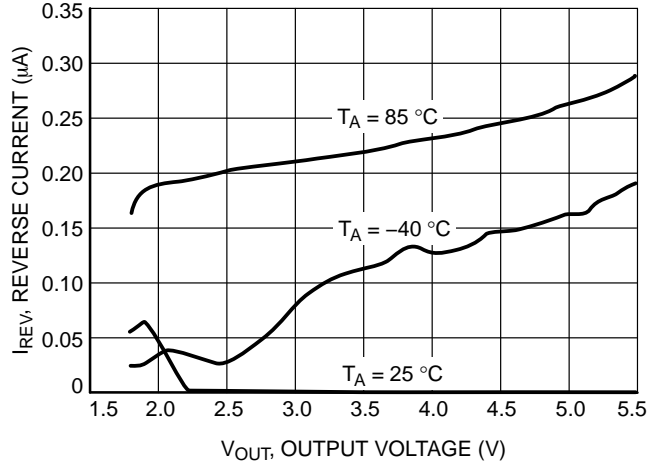

Figure 4. Reverse Current vs. Output Voltage

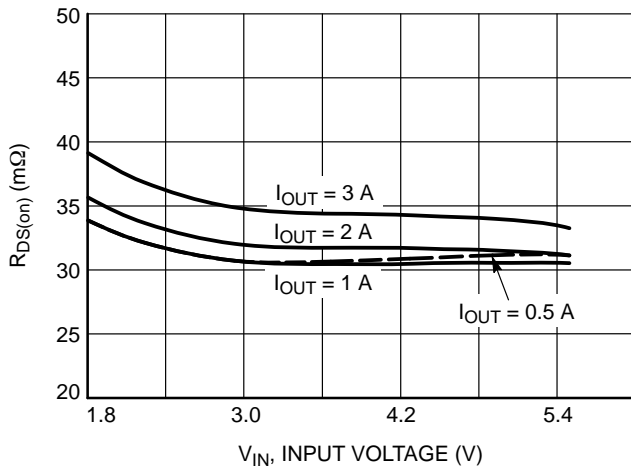

Figure 5. $R_{DS(on)}$ vs. V_{IN} Voltage at $25\text{ }^\circ\text{C}$

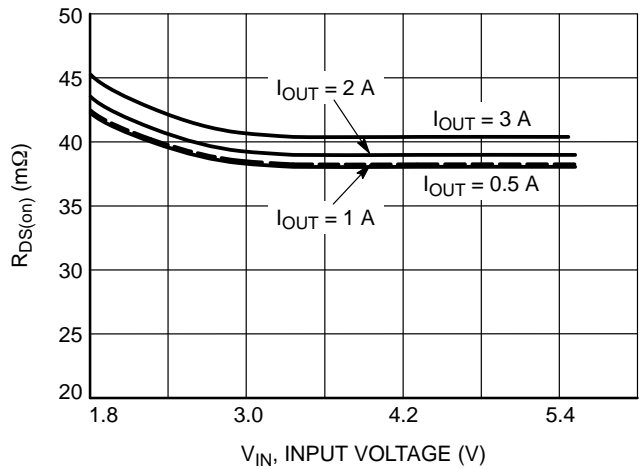

Figure 6. $R_{DS(on)}$ vs. V_{IN} Voltage at $85\text{ }^\circ\text{C}$

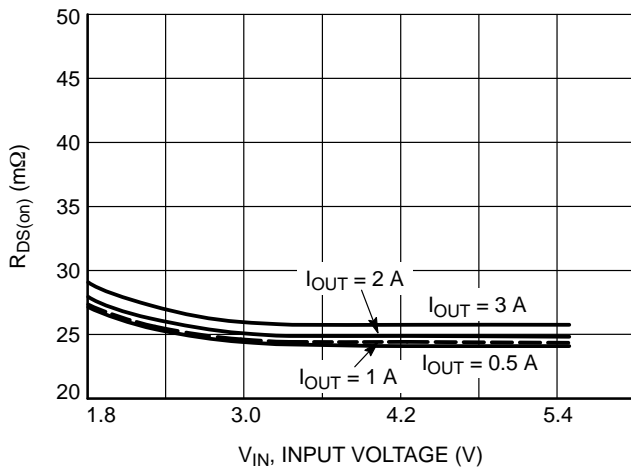

Figure 7. $R_{DS(on)}$ vs. V_{IN} Voltage at $-40\text{ }^\circ\text{C}$

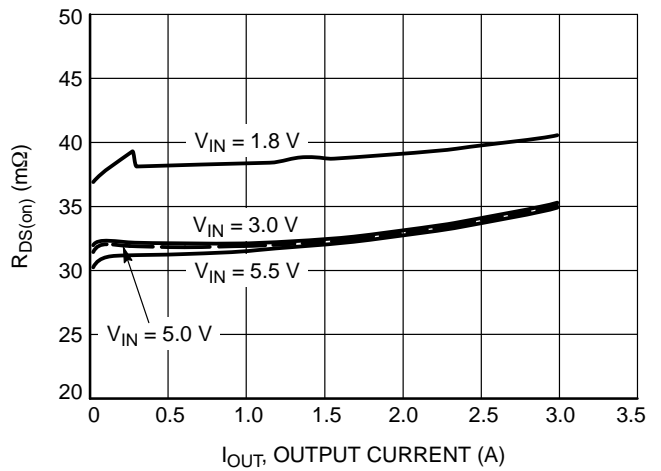

Figure 8. $R_{DS(on)}$ vs. I_{OUT} at $25\text{ }^\circ\text{C}$

TYPICAL CHARACTERISTICS

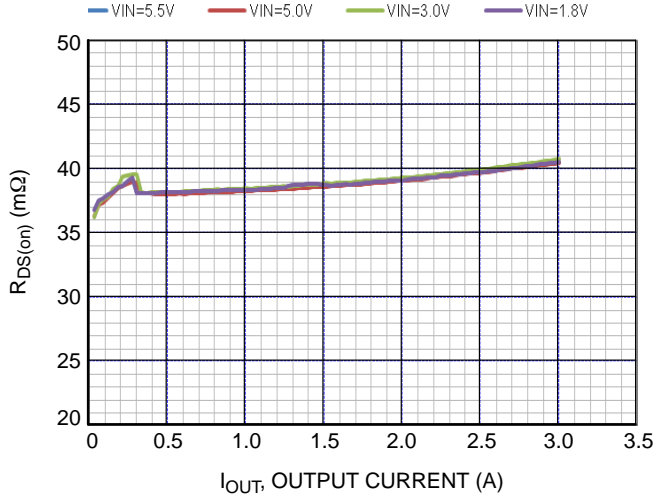

Figure 9. $R_{DS(on)}$ vs. I_{OUT} at 85 °C

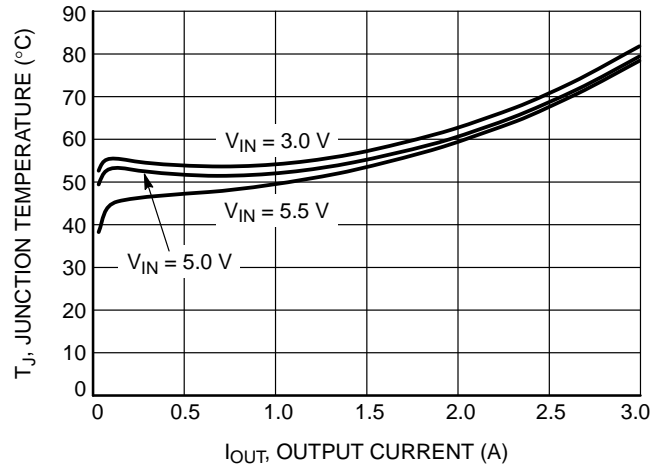

Figure 10. Junction Temperature vs. I_{OUT}

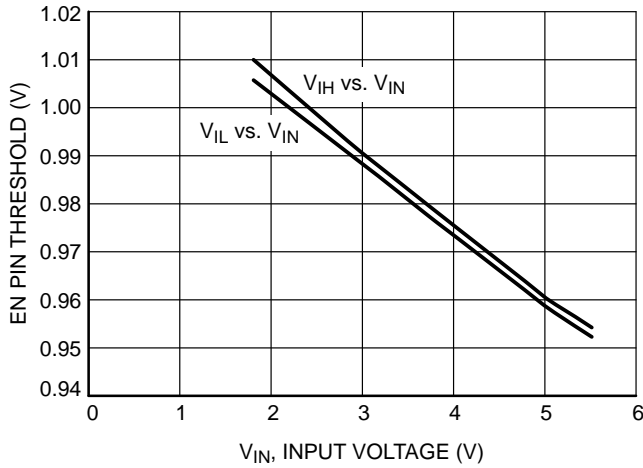

Figure 11. Logic Threshold vs. V_{IN}

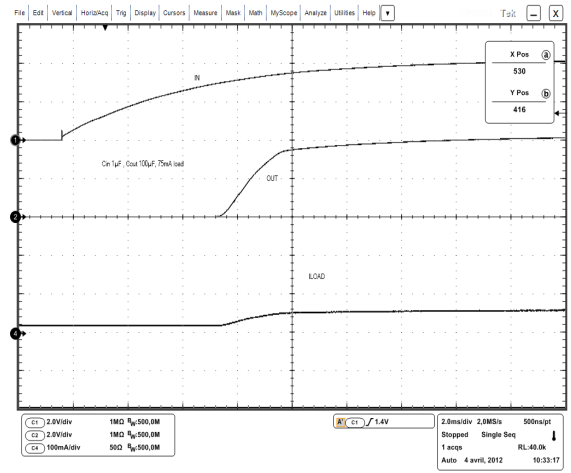

Figure 12. T_{ON} Time on 75 mA Load

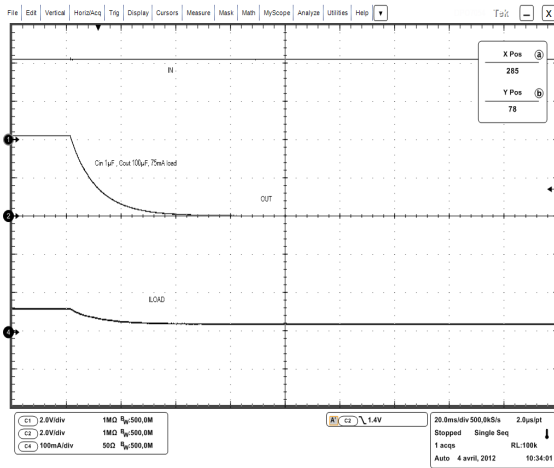

Figure 13. T_{OFF} Time on 75 mA Load

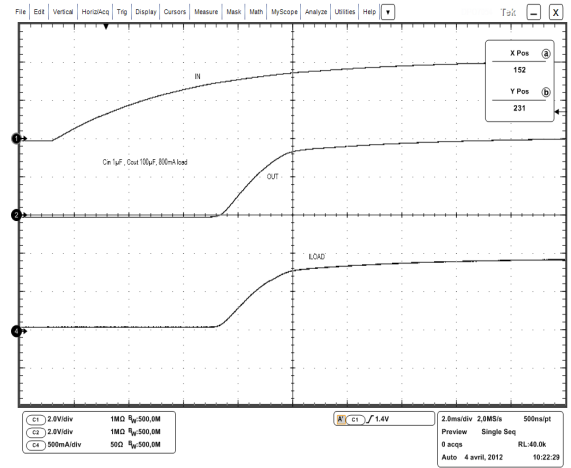

Figure 14. T_{ON} Time on 800 mA Load

NCP340

TYPICAL CHARACTERISTICS

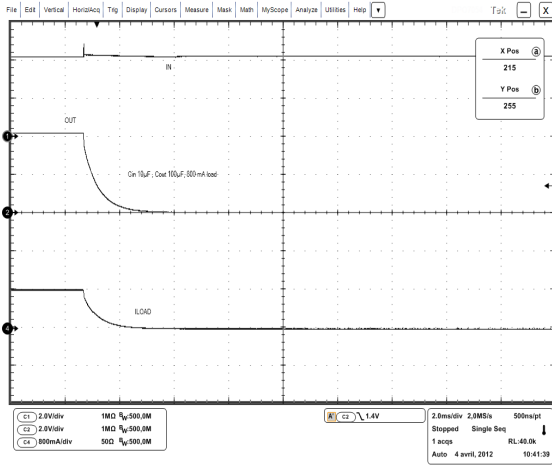

Figure 15. T_{OFF} Time on 800 mA Load

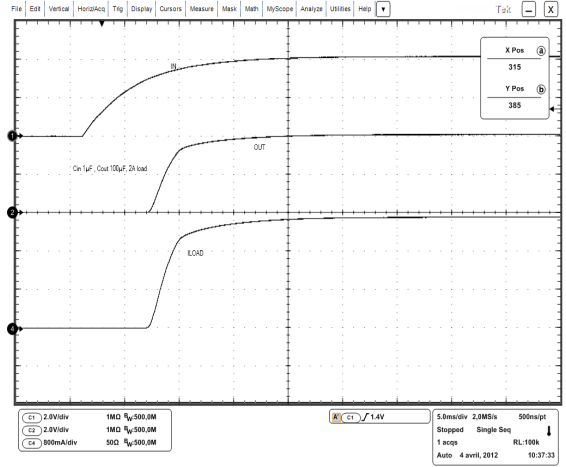

Figure 16. T_{ON} Time on 2 A Load

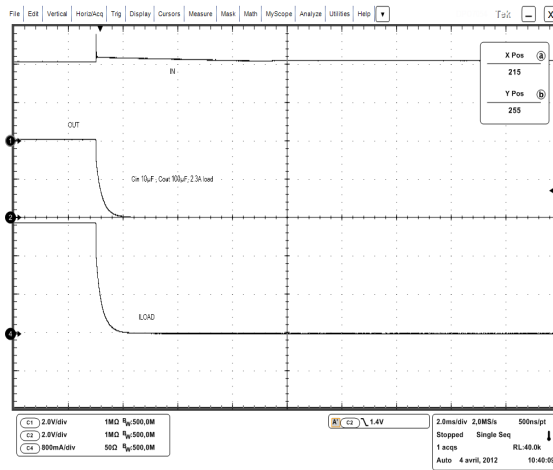

Figure 17. T_{OFF} Time on 2.3 A Load

NCP340

FUNCTIONAL DESCRIPTION

Overview

The NCP340 is a high side N-channel MOSFET power distribution switch designed to connect external voltage directly to the system. The high side MOSFET is automatically turned on if the Vin voltage is applied thanks to internal pull up connected between Vin and EN pin. The turned off is obtained by Vin removal. Due to the soft start circuitry, NCP340 is able to limit large voltage surges.

Enable input

Enable pin is an active high. The part is off when Vin is not present, limiting current consumption from battery to OUT pin.

In the other side, the part is automatically turned on when VIN is applied.

Blocking Control

The blocking control circuitry switches the bulk of the power NMOS. When the part is off (No VIN or EN tied to GND externally), the body diode limits the leakage current I_{REV} from OUT to IN. In this mode, anode of the body diode is connected to IN pin and cathode is connected to OUT pin. In operating condition, anode of the body diode is connected to OUT pin and cathode is connected to IN pin preventing the discharge of the power supply.

Cin Capacitor

A IN capacitor, 1 μF, at least, capacitor must be placed as close as possible the part to be Compliant with IEC61000-4-2 (Level 4).

Cout Capacitor

Depending on the sinking current during system start up and system turn off, a capacitor must be placed on the output. A 1 μF is strongly recommended but can be decreased down to 100 nF if the above two sequences are well controlled and parasitic inductance connected on the Vout line is negligible.

APPLICATION INFORMATION

Power Dissipation

The device's junction temperature depends on different contributor factor such as board layout, ambient temperature, device environment, etc... Yet, the main contributor in term of junction temperature is the power dissipation of the power MOSFET. Assuming this, the power dissipation and the junction temperature in normal mode can be calculated with the following equations:

$$P_D = R_{DS(on)} \times (I_{OUT})^2$$

P_D = Power dissipation (W)

R_{DS(on)} = Power MOSFET on resistance (Ω)

I_{OUT} = Output current (A)

$$T_J = P_D \times R_{\theta JA} + T_A$$

T_J = Junction temperature (°C)

R_{θJA} = Package thermal resistance (°C/W)

T_A = Ambient temperature (°C)

PCB Recommendations

The NCP340 integrates an up to 3 A rated NMOS FET, and the PCB design rules must be respected to properly evacuate the heat out of the silicon. The μDFN4 PAD1 must be connected to ground plane to increase the heat transfer if necessary. By increasing PCB area, the R_{θJA} of the package can be decreased, allowing higher power dissipation.

ORDERING INFORMATION

Device	Marking	Package	Shipping†
NCP340MUTBG	34	μDFN4, 1.2x1.6 mm (Pb-Free)	3000 / Tape & Reel

†For information on tape and reel specifications, including part orientation and tape sizes, please refer to our Tape and Reel Packaging Specifications Brochure, BRD8011/D.





SCALE 4:1

UDFN4 1.2x1.6, 0.5P
CASE 517CE
ISSUE B

DATE 03 APR 2012

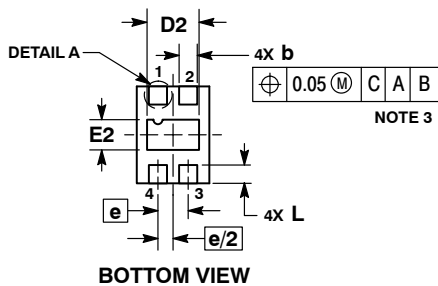
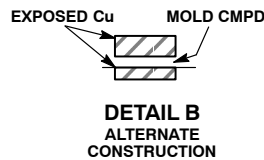
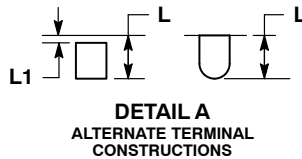
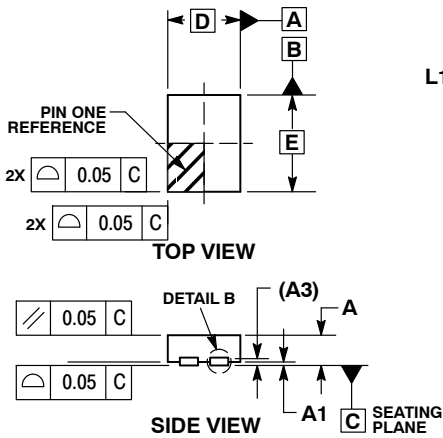

RECOMMENDED MOUNTING FOOTPRINT*

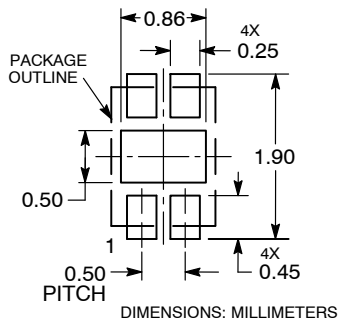

*For additional information on our Pb-Free strategy and soldering details, please download the onsemi Soldering and Mounting Techniques Reference Manual, SOLDERRM/D.

NOTES:

1. DIMENSIONING AND TOLERANCING PER ASME Y14.5M, 1994.
2. CONTROLLING DIMENSION: MILLIMETERS.
3. DIMENSION b APPLIES TO PLATED TERMINAL AND IS MEASURED BETWEEN 0.15 AND 0.20 mm FROM THE TERMINAL TIPS.
4. PACKAGE DIMENSIONS EXCLUSIVE OF BURRS AND MOLD FLASH.

MILLIMETERS			
DIM	MIN	NOM	MAX
A	0.45	0.50	0.55
A1	0.00	---	0.05
A3	0.13 REF		
b	0.25	0.30	0.35
D	1.20 BSC		
D2	0.76	0.86	0.96
E	1.60 BSC		
E2	0.40	0.50	0.60
e	0.50 BSC		
L	0.20	0.30	0.40
L1	---	---	0.15

GENERIC MARKING DIAGRAM*



XX = Specific Device Code
M = Date Code

*This information is generic. Please refer to device data sheet for actual part marking. Pb-Free indicator, "G" or microdot "▪", may or may not be present.

DOCUMENT NUMBER:	98AON6652E	Electronic versions are uncontrolled except when accessed directly from the Document Repository. Printed versions are uncontrolled except when stamped "CONTROLLED COPY" in red.
DESCRIPTION:	UDFN4, 1.2X1.6, 0.5P	PAGE 1 OF 1

onsemi and ONSEMI are trademarks of Semiconductor Components Industries, LLC dba onsemi or its subsidiaries in the United States and/or other countries. onsemi reserves the right to make changes without further notice to any products herein. onsemi makes no warranty, representation or guarantee regarding the suitability of its products for any particular purpose, nor does onsemi assume any liability arising out of the application or use of any product or circuit, and specifically disclaims any and all liability, including without limitation special, consequential or incidental damages. onsemi does not convey any license under its patent rights nor the rights of others.

onsemi, **Onsemi**, and other names, marks, and brands are registered and/or common law trademarks of Semiconductor Components Industries, LLC dba "**onsemi**" or its affiliates and/or subsidiaries in the United States and/or other countries. **onsemi** owns the rights to a number of patents, trademarks, copyrights, trade secrets, and other intellectual property. A listing of **onsemi**'s product/patent coverage may be accessed at www.onsemi.com/site/pdf/Patent-Marking.pdf. **onsemi** reserves the right to make changes at any time to any products or information herein, without notice. The information herein is provided "as-is" and **onsemi** makes no warranty, representation or guarantee regarding the accuracy of the information, product features, availability, functionality, or suitability of its products for any particular purpose, nor does **onsemi** assume any liability arising out of the application or use of any product or circuit, and specifically disclaims any and all liability, including without limitation special, consequential or incidental damages. Buyer is responsible for its products and applications using **onsemi** products, including compliance with all laws, regulations and safety requirements or standards, regardless of any support or applications information provided by **onsemi**. "Typical" parameters which may be provided in **onsemi** data sheets and/or specifications can and do vary in different applications and actual performance may vary over time. All operating parameters, including "Typicals" must be validated for each customer application by customer's technical experts. **onsemi** does not convey any license under any of its intellectual property rights nor the rights of others. **onsemi** products are not designed, intended, or authorized for use as a critical component in life support systems or any FDA Class 3 medical devices or medical devices with a same or similar classification in a foreign jurisdiction or any devices intended for implantation in the human body. Should Buyer purchase or use **onsemi** products for any such unintended or unauthorized application, Buyer shall indemnify and hold **onsemi** and its officers, employees, subsidiaries, affiliates, and distributors harmless against all claims, costs, damages, and expenses, and reasonable attorney fees arising out of, directly or indirectly, any claim of personal injury or death associated with such unintended or unauthorized use, even if such claim alleges that **onsemi** was negligent regarding the design or manufacture of the part. **onsemi** is an Equal Opportunity/Affirmative Action Employer. This literature is subject to all applicable copyright laws and is not for resale in any manner.

ADDITIONAL INFORMATION

TECHNICAL PUBLICATIONS:

Technical Library: www.onsemi.com/design/resources/technical-documentation
onsemi Website: www.onsemi.com

ONLINE SUPPORT: www.onsemi.com/support

For additional information, please contact your local Sales Representative at www.onsemi.com/support/sales