

带可调限流的全功能负载开关

FPF2193, FPF2194, FPF2195



WLCSP6 1.48x0.98x0.582
CASE 567RN

说明

FPF2193、FPF2194和FPF2195构成了一个负载开关系列，为可能会遇到大电流条件的系统和负载提供全面的保护。这些器件集成55 mΩ限流P沟道MOSFET，可在1.8至5.5 V的输入电压范围内工作。当MOSFET处于关闭状态，并且输出电压高于输入电压时，会阻止电流从输出流向输入。开关控制是通过能够直接连接低压控制信号的逻辑输入(ON)来实现的。每个部件均包含热关断保护功能，当持续的过流条件导致过热时，该功能会关闭开关，以防止损坏部件。

当开关电流达到限流值时，部件会在恒流模式下工作，以防止过量电流造成损坏。对于FPF2193和FPF2194，如果30 ms过后恒流条件依然存在，则这些部件将会关闭开关，并拉低故障信号引脚(FLAGB)。FPF2193具有自动重启特性，如果ON引脚在450 ms后仍处于激活状态，则该功能会重新启动开关。FPF2194不具有这项自动重启功能，因此开关将一直处于关闭状态，直到ON引脚被再次激活。出现限流故障后，FPF2195不会关闭，而是无限期地处于恒流模式。最小限流可设为低至45 mA。

这些部件采用节省空间的6球先进0.98 x 1.48 mm WLCSP封装。

特性

- 输入电压范围：<1.8至5.5 V
- 可控导通
- 可调限流范围：0.1至1.5 A
- 欠压锁定
- 热关断
- 关断电流：<2 μA
- 自动重启
- 快速限流响应时间
- 5 μs到中度过流
- 30 ns到短路
- 故障消隐
- 反向电流封锁

应用

- PDAs
- 手机
- 手持 GPS 设备
- 便携式商用/工业设备
- 数码相机
- 周边端口和附件
- 便携式医疗设备
- 热交换电源

MARKING DIAGRAM

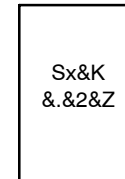

- Sx = Device Code (x = 6, 7, 9, Y)
- &K = 2-Digits Lot Run Traceability Code
- &. = Pin One Dot
- &2 = 2-Digit Date Code
- &Z = Assembly Plant Code

ORDERING INFORMATION

See detailed ordering and shipping information on page 12 of this data sheet.

FPF2193, FPF2194, FPF2195

应用框图



图1. 典型应用

框图

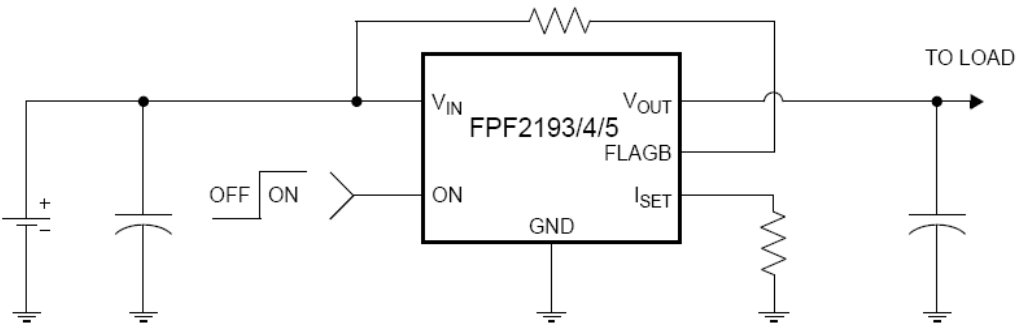

图2. 功能框图

FPF2193, FPF2194, FPF2195

引脚布局

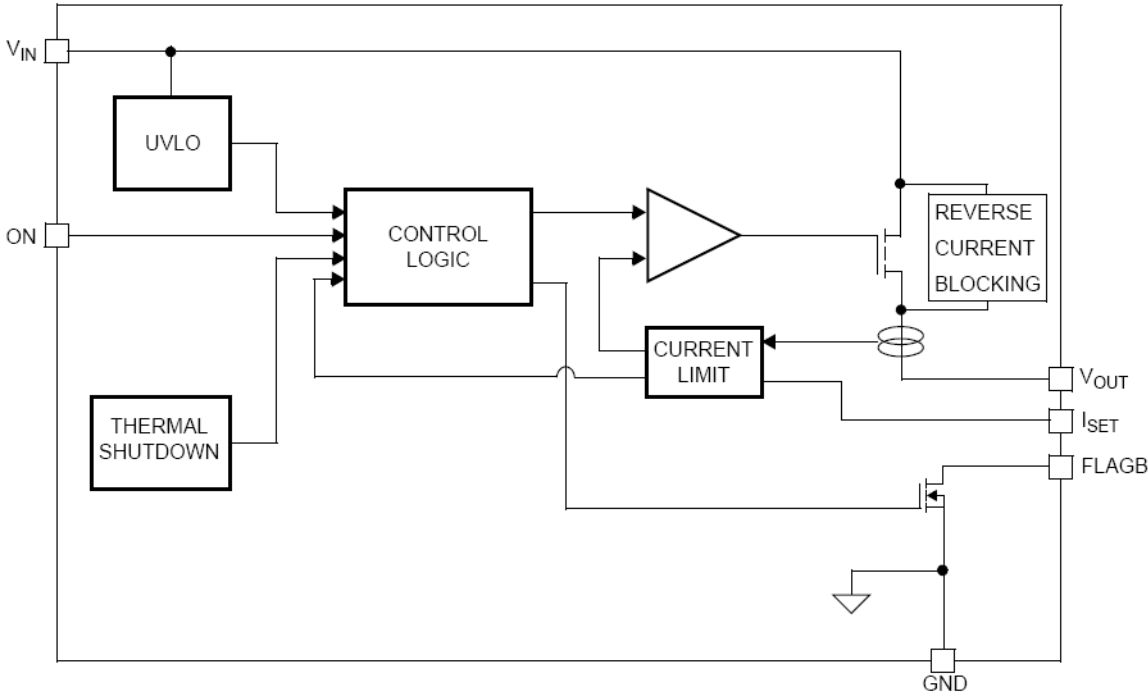

图3. 1.0 x 1.5 mm 晶圆级封装



图4. 引脚布局(底视图)

引脚说明

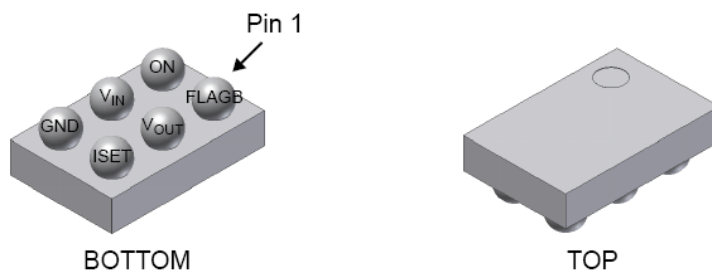
引脚号	名称	说明
C1	I _{SET}	电流限制设置输入。I _{SET} 与地之间的电阻设置开关的限流值。
B2	V _{IN}	电源输入。输入电源开关和 IC 的电源电压。
B1	V _{OUT}	开关输出。电源开关的输出。
A1	FLAGB	故障输出。低电平有效，打开漏极输出，其指示欠压或过温状态下的电流过大。
C2	GND	接地。
A2	ON	导通控制输入，高电平有效。

FPF2193, FPF2194, FPF2195

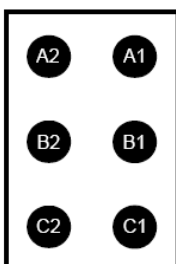
绝对最大额定值

符号	参数	最小值	最大值	单位	
	V_{IN} , V_{OUT} , ON, FLAGB, ISET 至 GND	-0.3	6.0	V	
P_D	$T_A = 25^\circ\text{C}$ (注意 1) 时的功耗	-	1.2	W	
T_J	工作温度范围	-40	+125	$^\circ\text{C}$	
T_{STG}	存储温度	-65	+150	$^\circ\text{C}$	
Θ_{JA}	结至环境热阻	-	85	$^\circ\text{C}/\text{W}$	
ESD	静电放电能力	人体模式, JESD22-A114	8000	-	V
		机械模式, JESD22-A115	400	-	

Stresses exceeding those listed in the Maximum Ratings table may damage the device. If any of these limits are exceeded, device functionality should not be assumed, damage may occur and reliability may be affected.

(参考译文)

如果电压超过最大额定值表中列出的值范围，器件可能会损坏。如果超过任何这些限值，将无法保证器件功能，可能会导致器件损坏，影响可靠性。

1. 在 1 平方英寸垫，2 oz 铜板上的封装功耗。

推荐工作条件

符号	参数	最小值	最大值	单位
V_{IN}	输入电压	1.8	5.5	V
T_A	工作环境温度	-40	+85	$^\circ\text{C}$

Functional operation above the stresses listed in the Recommended Operating Ranges is not implied. Extended exposure to stresses beyond the Recommended Operating Ranges limits may affect device reliability.

(参考译文)

高于推荐工作范围表格中所列电压时，不保证能够正常运行。长时间在推荐工作范围表格中规定范围以外的电压下运行，可能会影响器件的可靠性。

FPF2193, FPF2194, FPF2195

电气特性 ($V_{IN} = 1.8$ 至 5.5 V, 且 $T_A = -40$ 至 $+85^\circ\text{C}$ 除非另有说明。 $V_{IN} = 3.3$ V, $T_A = 25^\circ\text{C}$ 时为典型值)

符号	参数	工作条件	最小值	典型值	最大值	单位
----	----	------	-----	-----	-----	----

基本工作

V_{IN}	工作电压		1.8	-	5.5	V	
I_Q	静态电流	$I_{OUT} = 0$ mA, $V_{ON} = V_{IN}$	$V_{IN} = 1.8$ V	-	70	-	μA
			$V_{IN} = 3.3$ V	-	75	-	
			$V_{IN} = 5.5$ V	-	80	-	
R_{ON}	导通电阻	$T_A = 25^\circ\text{C}$, $I_{OUT} = 200$ mA	-	55	80	$\text{m}\Omega$	
		$T_A = -40$ to 85°C , $I_{OUT} = 200$ mA	-	-	135		
V_{IH}	ON 导通输入逻辑高电压	$V_{IN} = 1.8$ V	0.8	-	-	V	
		$V_{IN} = 5.5$ V	1.4	-	-		
V_{IL}	导通输入逻辑低电压	$V_{IN} = 1.8$ V	-	-	0.5	V	
		$V_{IN} = 5.5$ V	-	-	1.0		
I_{IN}	导通输入漏电流	$V_{ON} = V_{IN}$ 或接地	-1	0	1	μA	
V_{IN_SD}	V_{IN} 关断电流	$V_{ON} = 0$ V, $V_{IN} = 5.5$ V, $V_{OUT} =$ 短路至GND	-2	-	2	μA	
V_{FLB_L}	FLAGB 输出逻辑低电压	$V_{IN} = 5$ V, $I_{SINK} = 10$ mA	-	0.05	0.20	V	
		$V_{IN} = 1.8$ V, $I_{SINK} = 10$ mA	-	0.12	0.30		
I_{FLB_H}	FLAGB 输出逻辑高漏电流	$V_{IN} = 5$ V, 开关导通	-	-	1	μA	

反向阻断

I_{SDT}	V_{OUT} 关断电流	$V_{ON} = 0$ V, $V_{OUT} = 5.5$ V, $V_{IN} =$ 短路至GND	-2	-	2	μA
$V_{breakdown}$	反向击穿电压	$V_{IN} = V_{ON} = 0$ V, $I_{OUT} = 200$ μA	-	9	-	V

保护

I_{LIM}	限流	$V_{IN} = 3.3$ V, $V_{OUT} = 3.0$ V, $R_{SET} = 690$ Ω	600	800	1000	mA
	FPF2195BUCX限流	$V_{IN} = 4.5$ V, $V_{OUT} = 4.2$ V, $R_{SET} = 15.8$ k Ω	35	45	60	mA
$I_{LIM(MIN)}$	电流限值最小值	$V_{IN} = 3.3$ V, $V_{OUT} = 3.0$ V, $R_{SET} = 5516$ Ω	-	100	-	mA
T_{SD}	热关断	关断阈值	-	140	-	$^\circ\text{C}$
		从关闭中恢复	-	130	-	
		滞环	-	10	-	
V_{UVLO}	欠压锁定	V_{IN} 升高	1.55	1.65	1.75	V
V_{UVLO_HYST}	欠压锁定滞环宽度		-	50	-	mV

动态

t_{dON}	延迟导通时间	$R_L = 500$ Ω , $C_L = 0.1$ μF	-	20	-	μs
t_R	V_{OUT} 上升时间	$R_L = 500$ Ω , $C_L = 0.1$ μF	-	20	-	μs
t_{ON}	导通时间	$R_L = 500$ Ω , $C_L = 0.1$ μF	-	40	-	μs
t_{dOFF}	延迟关断时间	$R_L = 500$ Ω , $C_L = 0.1$ μF	-	15	-	μs
t_F	V_{OUT} 下降时间	$R_L = 500$ Ω , $C_L = 0.1$ μF	-	110	-	μs
t_{OFF}	关断时间	$R_L = 500$ Ω , $C_L = 0.1$ μF	-	125	-	μs
t_{BLANK}	过电流死区时间	FPF2193, FPF2194	15	30	60	ms
t_{RSTRT}	自动重启	仅限于FPF2193	225	450	900	ms
t_{SC}	短路响应时间	$V_{IN} = V_{OUT} = 3.3$ V, 中度过流	-	5	-	μs
		$V_{IN} = V_{OUT} = 3.3$ V, 短路	-	30	-	ns

Product parametric performance is indicated in the Electrical Characteristics for the listed test conditions, unless otherwise noted. Product performance may not be indicated by the Electrical Characteristics if operated under different conditions.

(参考译文)

除非另有说明,“电气特性”表格中列出的是所列测试条件下的产品性能参数。如果在不同条件下运行,产品性能可能与“电气特性”表格中所列性能参数不一致。

典型性能特征



图5. 静态电流与输入电压的关系



图6. 静态电流与输入电压的关系

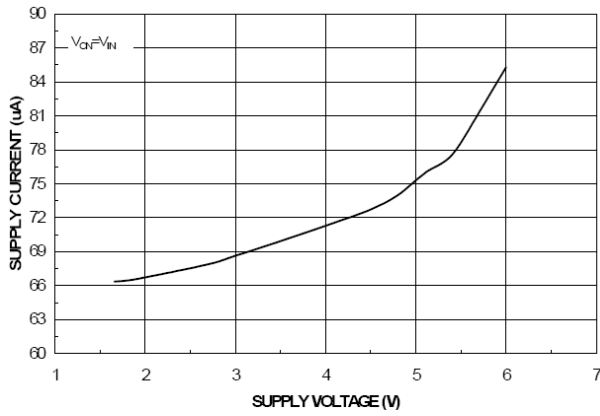

图7. 静态电流与温度的关系

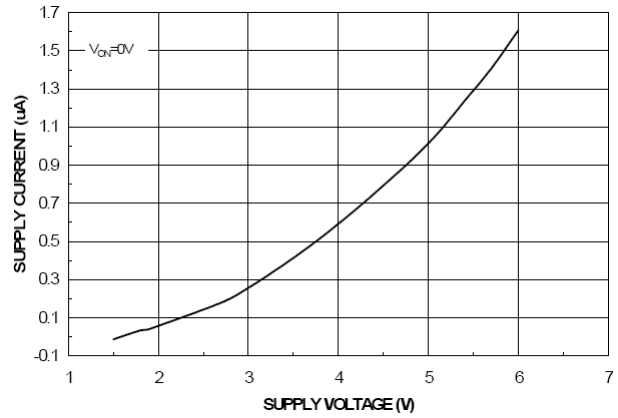

图8. V_ON高电压与输入电压的关系

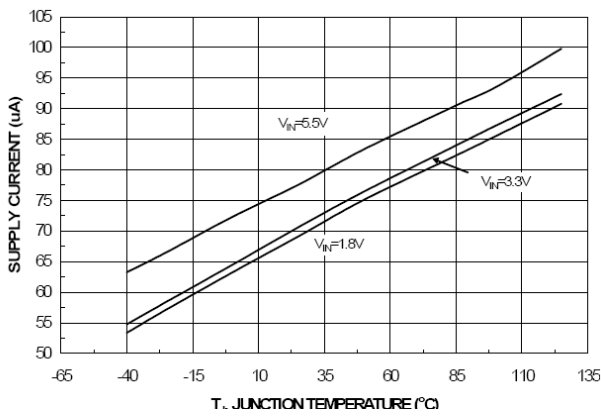

图9. V_ON低电压与输入电压的关系

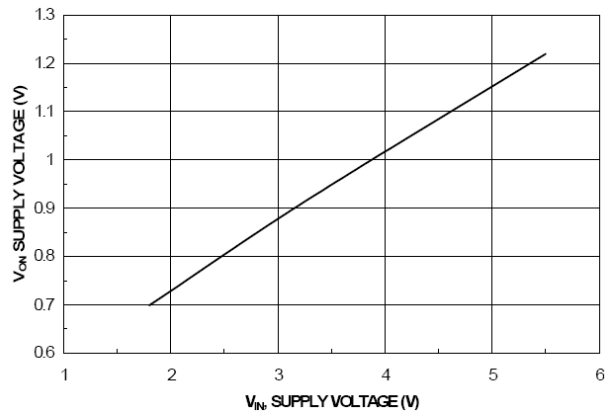

图10. 电流限值与输出电压的关系

FPF2193, FPF2194, FPF2195

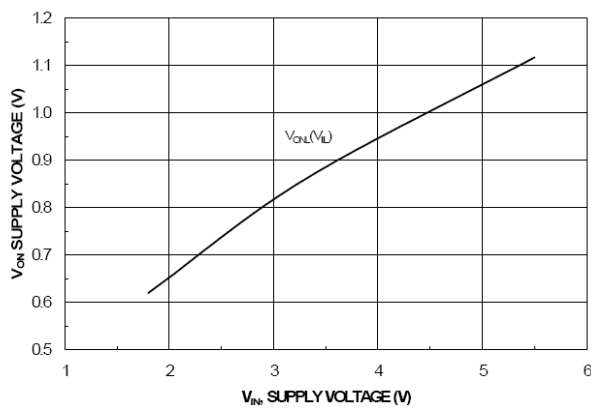
典型性能特征 (接上页)

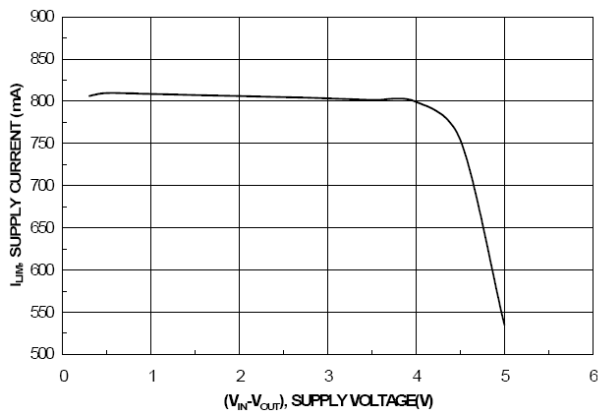

图11. 电流限值与温度的关系



图12. R_{ON}与 V_{IN}的关系

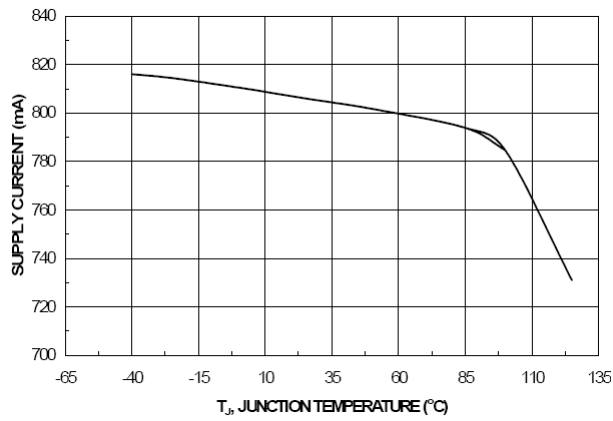

图13. R_{ON}与温度的关系

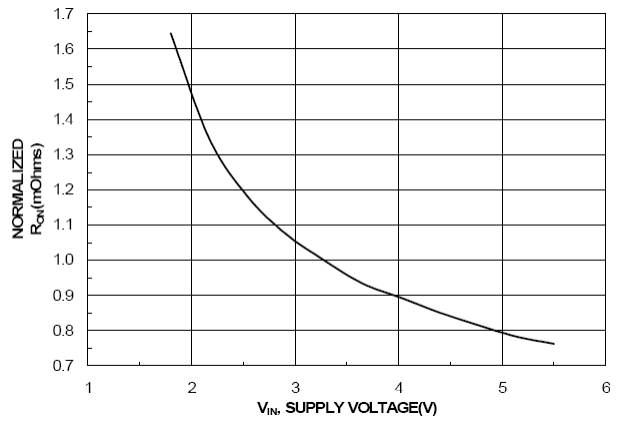

图14. t_{ON} / t_{OFF}与温度的关系

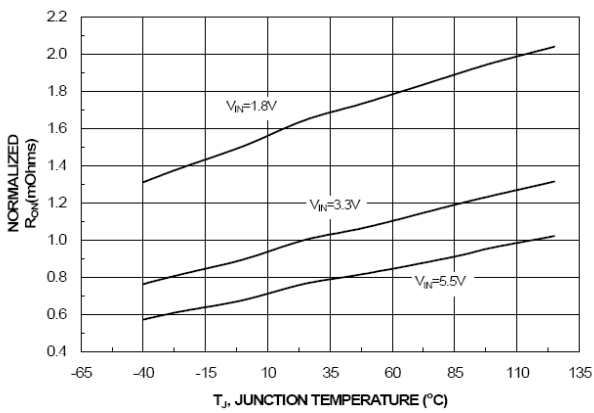

图15. t_{RISE} / t_{FALL}与温度的关系

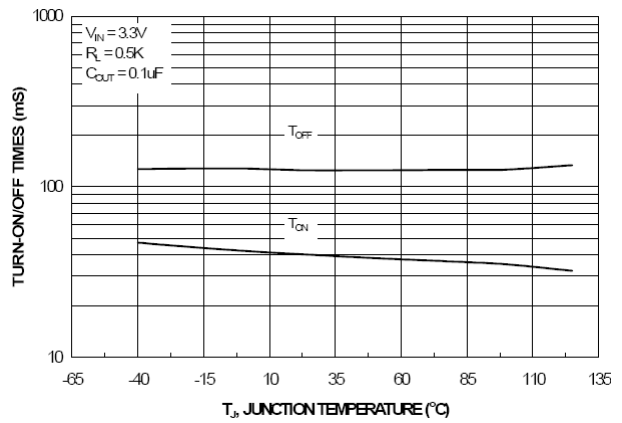

图16. t_{RSTRT}与温度的关系

典型性能特征 (接上页)

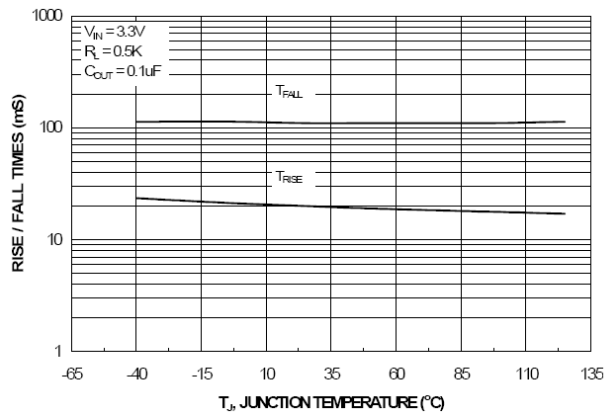

图17. t_{BLANK} 与温度的关系

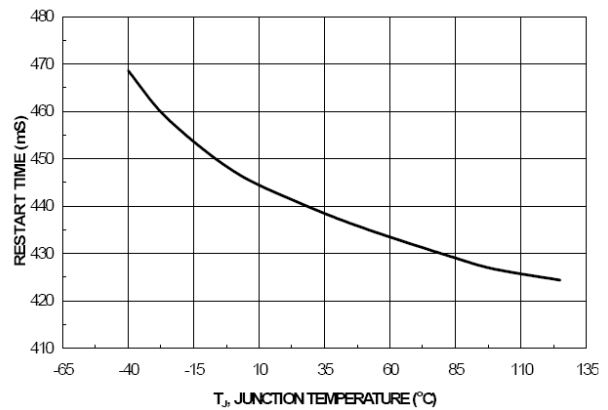

图18. t_{ON} 响应

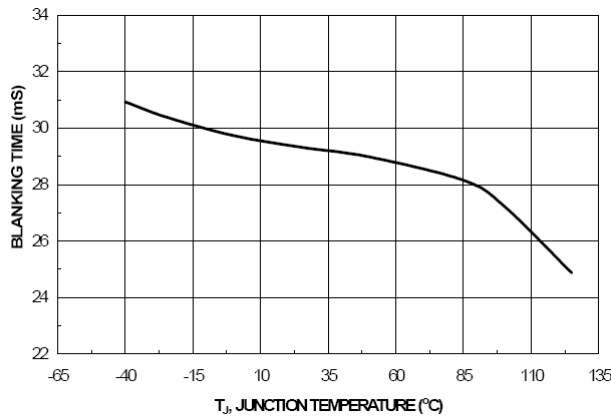

图19. t_{OFF} 响应

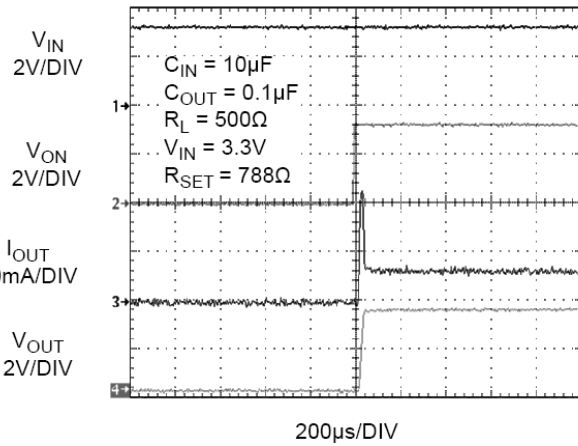

图20. 短路响应时间
(输出短路至GND)

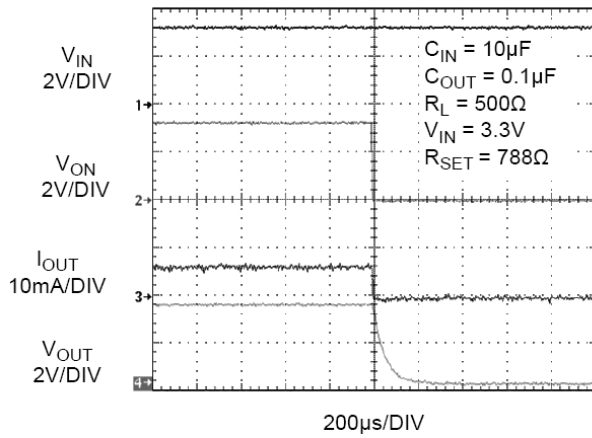

图21. 限流响应时间
(开关上电至短路)

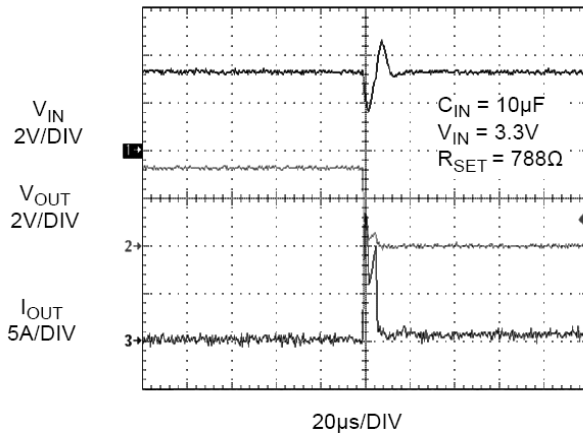

图22. 电流限制响应时间
(输出Ω C_{OUT} = 0.1 µF)

典型性能特征 (接上页)

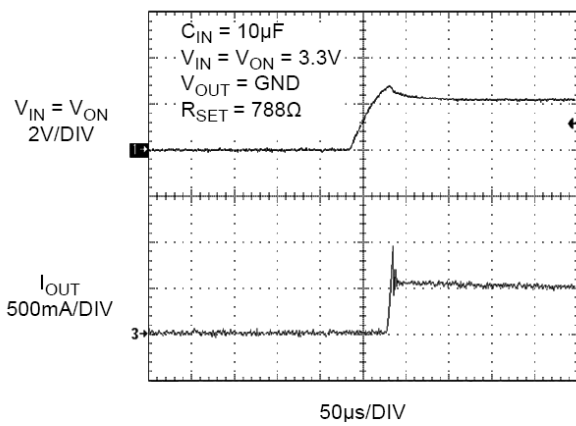

图23. 电流限制响应时间
(输出端 $C_{OUT} = 10 \mu\text{F}$)

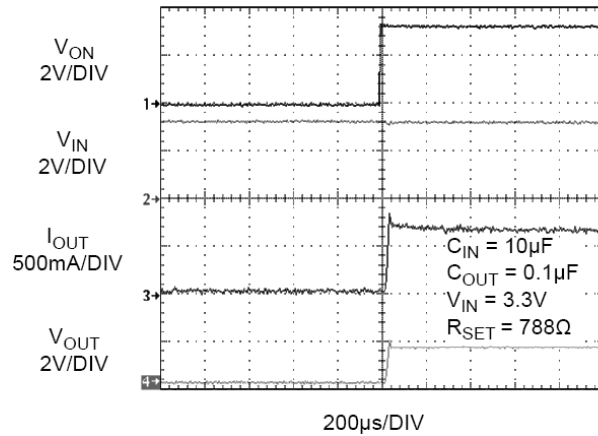

图24. 短路检测功能(注意2)

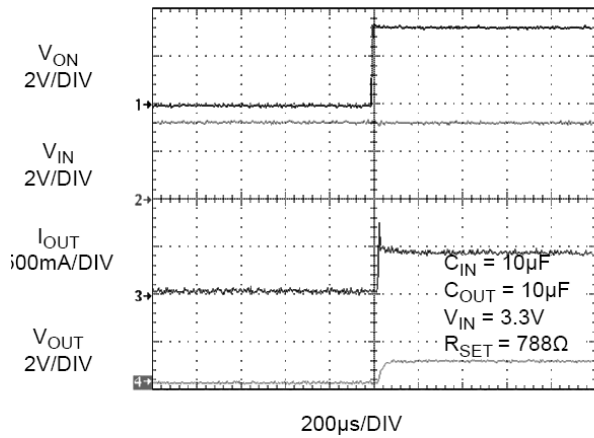

图25. t_{BLANK} 与 响应(注意3)的关系

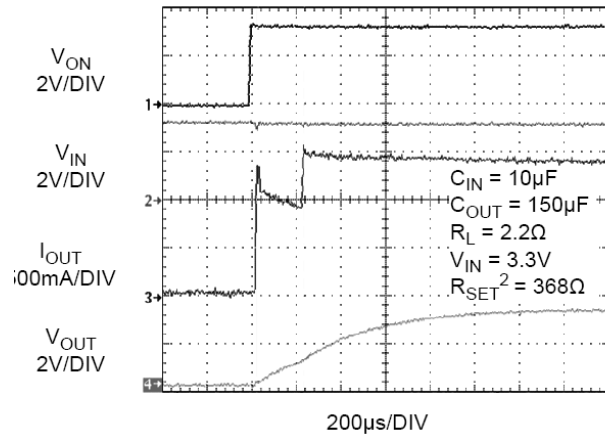

图26. $t_{RESTART}$ 与 响应(注意3)的关系

注意:

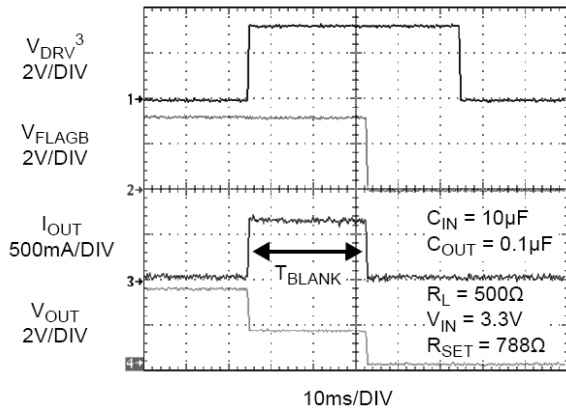
2. 输出电压低于时, 电流限制值设置为限流值的62.5%。
3. V_{DRV} 信号通过负载使器件进入过流状态。

功能说明

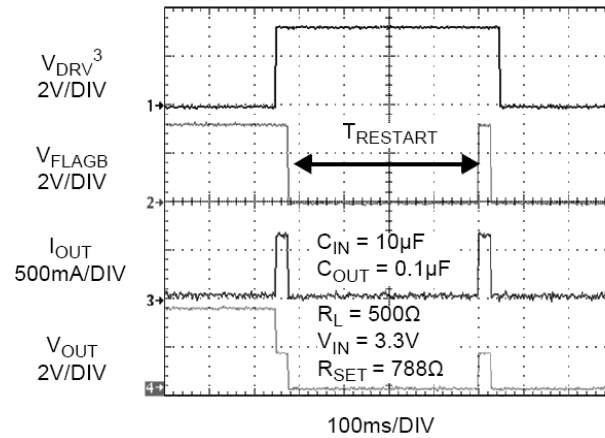
The FPF2193, FPF2194,和FPF2195为电流限制开关,可保护系统和负载避免在过高电流应用时受到损坏。各器件的核心均为55 mΩ P沟道MOSFET和控制器,可在1.8 – 5.5 V宽输入电压范围内工作。控制器利用限流、欠压闭锁和热关断等功能提供针对系统故障的保护。利用所选外部电阻,限流值可在100 mA (FPF2195BUCX为45 mA)至1.5 A范围内调节。

导通/关断控制

ON 引脚控制开关状态。ON 引脚高电平时,开关导通。有效的 ON 引脚可在不出现故障的情况下保持开关的导通状态。对于所有版本, V_{IN} 欠压或结温超过40°C,会覆盖ON 控制,关断开关。此外,过电流会导致FPF2193和FPF2194的开关关闭。FPF2193具有自动重启功能,可在450 ms后自动重新启动开关。对于FPF2194,必须切换ON 引脚,才能再次启动开关。FPF2195不会因响应过电流而关断,但在ON 有效期间将以恒流模式继续工作,且欠压闭锁和热关断功能无效。

故障报告

一旦检测到过流,输入欠压或过温现象,FLAGB 通过启动低电平发出故障模式信号。对于FPF2193 和FPF2194,FLAGB 将在死区时间结束时变为低电平,而FPF2195 上的FLAGB 将立刻变为低电平。FPF2195 的自动重启时间内,FLAGB 保持为低电平。对于FPF2194,FLAGB 锁存于低电平且ON 引脚必须切换进行释放。对于FPF2195,故障期间FLAGB 为低电平,并在故障状态结束时立刻恢复为高电平。FLAGB 是一个开漏MOSFET,需要在 V_{IN} 和FLAGB 之间加上一个上拉电阻。关断期间,禁止下拉FLAGB,以减少对电源电流的需求。

电流限制

电流限制可确保通过开关的电流不会超过一个最大值,而对其最小值不做限制。通过选择与 I_{SET} 连接的外接电阻,可以调节电流限值。关于电阻选择的更多信息,可在应用信息章节查询。FPF2193 和FPF2194 具有一段长30ms 死区时间,在此期间开关将作为恒流源工作。死区时间结束时,开关关断。FPF2195没有电流限制死区时间,因此在ON 引脚无效或热关断关闭开关之前,将持续以恒流状态工作。

在重载或引入短路侦测功能期间,防止开关功耗过高。通过观测输出电压,可侦测短路情况。如果开关电路负载过重,则开关将进入短路电流限制模式。输出电压降至 V_{SCTH} 以下后,短路侦测阈值电压,电流限制值重新调整,且短路电流限值降至电流限值的

62.5%。即便在输入电压达5.5 V时,也可将部件的功耗降至特定限值以下。将 V_{SCTH} 值设为1 V。在1.1 V输出电压附近,移除短路限流模式中的开关,并将限流设为限流值。

欠压闭锁(UVLO)

当输入电压低于欠压闭锁阈值时,欠压闭锁功能将关闭开关。ON 引脚有效,令输入电压提高至欠压闭锁阈值之上,可将限制电流冲击的开关控制导通。

热关断

热关闭可防止晶圆内部或外部产生过高温度。在过温的情况下,FLAGB 有效,且开关关断。当晶圆温度降至阈值温度以下时,开关将再次自动导通。

反向电流封锁

整个FPF2193/94/95系列具有反向电流封锁功能,可保护输入电源,防止电流从输出流向输入。对于一个标准的USB 电源设计而言,该项功能非常重要,可保护USB 主机,避免因 V_{BUS} 反向电流损坏。

负载开关关断时,没有电流从输出流向输入。若开关打开且输出电压大于输入电压,将激活该功能并关断开关。可防止任何电流从输出流向输入。若 $V_{OUT} - V_{IN}$ 小于阈值典型值50 mV,反向电流封锁功能则去激活。在此期间,当输入电压变得比输出电压高时,会有部分电流(50 mV/ R_{ON})从输出流向输入。FLAGB 操作独立于反向电流封锁功能,并且在启用该项功能时不会报告故障情况。



图27. 时序图

其中:

- t_{dON} = 延迟导通时间
- t_r = V_{OUT} 上升时间
- t_{ON} = 导通时间
- t_{dOFF} = 延迟关断时间
- t_f = V_{OUT} 下降时间
- t_{OFF} = 关断时间

应用信息

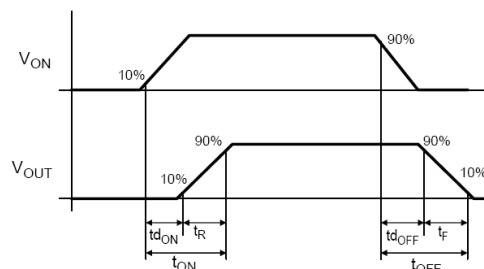

图28. 典型应用

设置电流限制

FPF2193, FPF2194, 和FPF2195 具有电流限制, 通过 I_{SET} 和GND 之间外接的电阻来设置。根据下列公式选择电阻

$$R_{SET} = \frac{551.6}{I_{LIM}} \quad (\text{eq. 1})$$

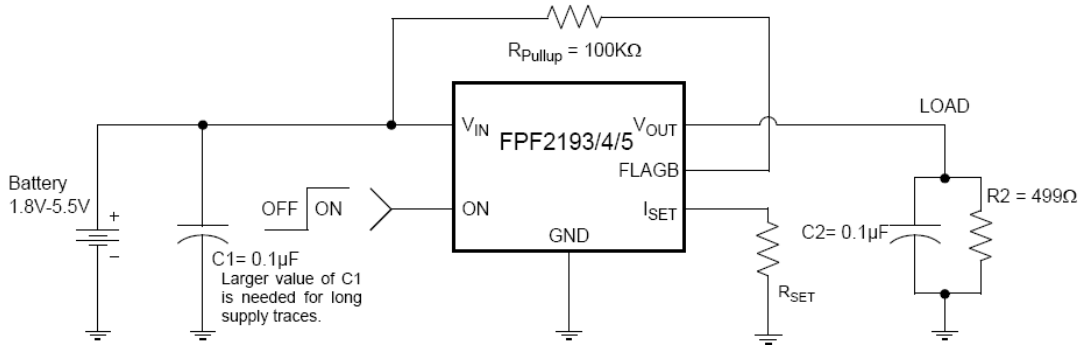
R_{SET} 单位为 Ω , 而 I_{SET} 单位为A。

表1 也可用于选择 R_{SET} 。典型应用为单个USB端口所需的500 mA电流。使用表1, 则选择的 R_{SET} 电阻值应为788 Ω 。从而确保该端口可吸引525 mA的电流, 但不超过 875 mA。双端口系统类似, 阻值为368 Ω 的 R_{SET} 可传输电流至少为1125 mA, 但不超过 1875 mA。

表1. 电流限制不同的 R_{SET} 值

R_{SET} (Ω)	电流限值最小值 (mA)	典型值 电流限值 (mA)	电流限值最大值 (mA)
368	1125	1500	1875
441	928	1250	1562
552	750	1000	1250
613	675	900	1125
690	600	800	1000
788	525	700	875
919	450	600	750
1103	375	500	625
1226	338	450	563
1379	300	400	500
1576	263	350	438
1839	225	300	375
2206	188	250	313
2758	150	200	250
3677	113	150	188
5516	75	100	125
15800 (注意4)	35	45	60

4. 仅FPF2195BUCX。

输入电容

为防止开关导通至放电负载电容或短路造成的瞬态电流冲击造成的输入电源电压跌落, 应在 V_{IN} 和GND 之间放置一个电容。通常靠近引脚放置一个 0.1 μF 的陶瓷电容 C_{IN} 即可。可使用 C_{IN} 的较大值进一步降低电压跌落。

输出电容

应在 V_{OUT} 和GND 之间放置一个0.1 μF 的电容器 C_{OUT} 。开关关断时, 该电容可防止板寄生电感令 V_{OUT} 低于GND。对于FPF2193 和FPF2194, 总输出电容应低于最大值 $C_{OUT(max)}$, 以防止该部件寄存过流状态并关断开关。通过下列公式可确定最大输出电容,

$$C_{OUT(max)} = \frac{I_{LIM(max)} \times t_{BLANK(min)}}{V_{IN}} \quad (\text{eq. 2})$$

功耗

开关正常工作期间, 器件的功耗取决于所设置的电流限制。电流限制允许设置的最大值为1.5 A, 其功耗为,

$$C_{OUT(max)} = \frac{I_{LIM(max)} \times t_{BLANK(min)}}{V_{IN}} \quad (\text{eq. 3})$$

若器件达到电流限值, 输出短接至地时会出现最大功耗。对于FPF2193,功耗与自动重启时间 t_{RSTRT} 和过流死区时间 t_{BLANK} 成比例, 因此最大功耗为:

$$P(max) = \frac{t_{BLANK}}{t_{BLANK} + t_{RSTRT}} \times V_{IN(max)} \times I_{LIM(max)} = \frac{30}{30 + 450} \times 5.5 \times 1.5 = 515.6 \text{ mW} \quad (\text{eq. 4})$$

会出现封装承受的功率, 但器件可启用热关闭, 保护器件免受过高温度的损坏。使用FPF2194 时, 必须认真阅读手册中有关器件重置的内容。结温最高只能达到热关断阈值。达到该温度时, 切换ON 引脚也无法导通开关, 直至结温下降。对于FPF2195,输出短路会造成器件以恒流状态工作, 功耗较大,

$$P(max) = V_{IN(max)} \times I_{LIM(max)} = 5.5 \times 1.5 = 8.25 \text{ W} \quad (\text{eq. 5})$$

FPF2193, FPF2194, FPF2195

大功率会造成热关闭，当ON 引脚有效并出现短路时，器件将在热关闭的开闭之间循环。

线路板布局

若要实现最佳效果，所有的线路应尽量短。若要实现最高效率，输入和输出电容应尽可能靠近器件放置，从而尽量降低正常和短路工作时的寄生电感。 V_{IN} , V_{OUT} , 和GND引脚使用较宽敷线，有助于降低寄生电感，以及壳至环境的热阻。

订购信息

器件编号	电流限值 (mA)	电流限制死区时间 (ms)	自动重启时间 (ms)	激活 ON 引脚	顶标	Package Type	Shipping [†]
FPF2193	100 – 1500	15/30/60	225/450/900	高电平有效	S6	WLCSP6 1.48x0.98x0.582 (Pb-Free)	3000 / Tape & Reel
FPF2194		15/30/60	NA		S7		3000 / Tape & Reel
FPF2195		0	NA		S9		3000 / Tape & Reel
FPF2195BUCX	45 – 1500	0S	NA		SY		3000 / Tape & Reel

[†]For information on tape and reel specifications, including part orientation and tape sizes, please refer to our Tape and Reel Packaging Specifications Brochure, BRD8011/D.



WLCSP6 1.48x0.98x0.582
CASE 567RN
ISSUE O

DATE 30 NOV 2016

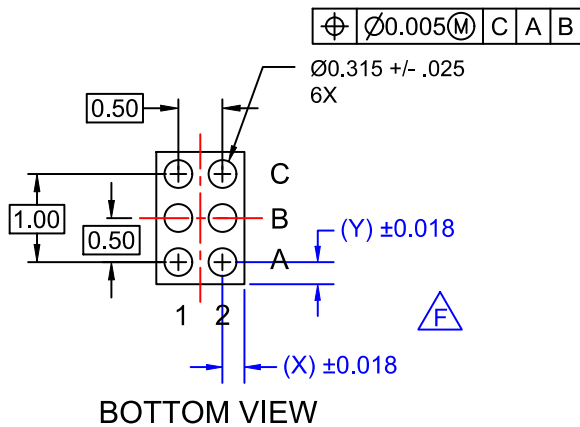
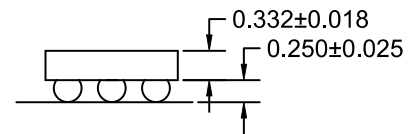
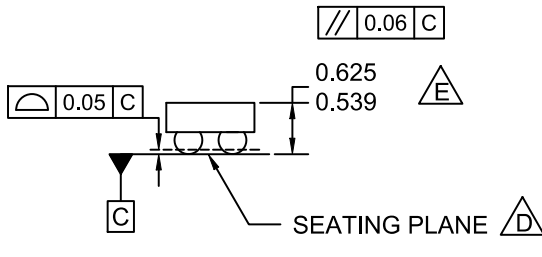
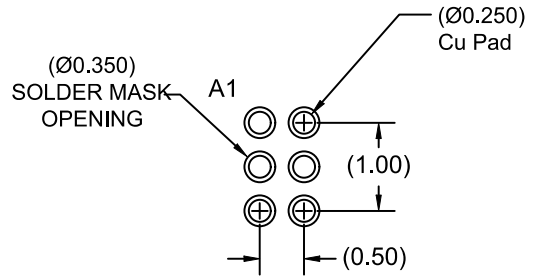
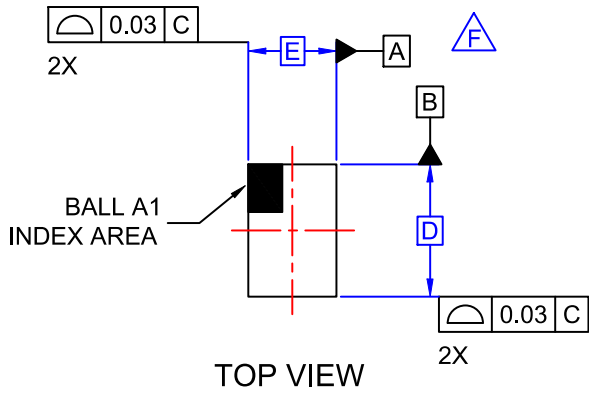

NOTES:

- A. NO JEDEC REGISTRATION APPLIES.
- B. DIMENSIONS ARE IN MILLIMETERS.
- C. DIMENSIONS AND TOLERANCE PER ASMEY14.5M, 1994.
- D** DATUM C IS DEFINED BY THE SPHERICAL CROWNS OF THE BALLS.
- E** PACKAGE NOMINAL HEIGHT IS 582 MICRONS ±43 MICRONS (539-625 MICRONS).
- F** FOR DIMENSIONS D, E, X, AND Y SEE PRODUCT DATASHEET.

DOCUMENT NUMBER:	98AON16581G	Electronic versions are uncontrolled except when accessed directly from the Document Repository. Printed versions are uncontrolled except when stamped "CONTROLLED COPY" in red.
DESCRIPTION:	WLCSP6 1.48x0.98x0.582	PAGE 1 OF 1

ON Semiconductor and are trademarks of Semiconductor Components Industries, LLC dba ON Semiconductor or its subsidiaries in the United States and/or other countries. ON Semiconductor reserves the right to make changes without further notice to any products herein. ON Semiconductor makes no warranty, representation or guarantee regarding the suitability of its products for any particular purpose, nor does ON Semiconductor assume any liability arising out of the application or use of any product or circuit, and specifically disclaims any and all liability, including without limitation special, consequential or incidental damages. ON Semiconductor does not convey any license under its patent rights nor the rights of others.

onsemi, **Onsemi**, and other names, marks, and brands are registered and/or common law trademarks of Semiconductor Components Industries, LLC dba "**onsemi**" or its affiliates and/or subsidiaries in the United States and/or other countries. **onsemi** owns the rights to a number of patents, trademarks, copyrights, trade secrets, and other intellectual property. A listing of **onsemi**'s product/patent coverage may be accessed at www.onsemi.com/site/pdf/Patent-Marking.pdf. **onsemi** reserves the right to make changes at any time to any products or information herein, without notice. The information herein is provided "as-is" and **onsemi** makes no warranty, representation or guarantee regarding the accuracy of the information, product features, availability, functionality, or suitability of its products for any particular purpose, nor does **onsemi** assume any liability arising out of the application or use of any product or circuit, and specifically disclaims any and all liability, including without limitation special, consequential or incidental damages. Buyer is responsible for its products and applications using **onsemi** products, including compliance with all laws, regulations and safety requirements or standards, regardless of any support or applications information provided by **onsemi**. "Typical" parameters which may be provided in **onsemi** data sheets and/or specifications can and do vary in different applications and actual performance may vary over time. All operating parameters, including "Typicals" must be validated for each customer application by customer's technical experts. **onsemi** does not convey any license under any of its intellectual property rights nor the rights of others. **onsemi** products are not designed, intended, or authorized for use as a critical component in life support systems or any FDA Class 3 medical devices or medical devices with a same or similar classification in a foreign jurisdiction or any devices intended for implantation in the human body. Should Buyer purchase or use **onsemi** products for any such unintended or unauthorized application, Buyer shall indemnify and hold **onsemi** and its officers, employees, subsidiaries, affiliates, and distributors harmless against all claims, costs, damages, and expenses, and reasonable attorney fees arising out of, directly or indirectly, any claim of personal injury or death associated with such unintended or unauthorized use, even if such claim alleges that **onsemi** was negligent regarding the design or manufacture of the part. **onsemi** is an Equal Opportunity/Affirmative Action Employer. This literature is subject to all applicable copyright laws and is not for resale in any manner.

ADDITIONAL INFORMATION

TECHNICAL PUBLICATIONS:

Technical Library: www.onsemi.com/design/resources/technical-documentation
onsemi Website: www.onsemi.com

ONLINE SUPPORT: www.onsemi.com/support

For additional information, please contact your local Sales Representative at www.onsemi.com/support/sales