

# IntelliMAX™ Advanced Load Management Products

## FPF1005 - FPF1006

### General Description

The FPF1005 & FPF1006 are low  $R_{DS}$  P-Channel MOSFET load switches with CMOS controlled turn-on targeting small package load switch applications. The input voltage range operates from 1.2 V to 5.5 V. Switch control is by a logic input (ON) capable of interfacing directly with low voltage control signals. In FPF1006, 120  $\Omega$  on-chip load resistor is added for output quick discharge when switch is turned off.

Both FPF1005 & FPF1006 are available in a small 2X2 MicroFET-6 pin plastic package.

### Features

- 1.2 to 5.5 V Input Voltage Range
- Typical  $R_{DS(ON)} = 50 \text{ m}\Omega @ V_{IN} = 5.5 \text{ V}$
- Typical  $R_{DS(ON)} = 55 \text{ m}\Omega @ V_{IN} = 3.3 \text{ V}$
- ESD Protected, above 2000 V HBM
- These Devices are Pb-Free and are RoHS Compliant

### Applications

- PDAs
- Cell Phones
- GPS Devices
- MP3 Players
- Digital Cameras
- Peripheral Ports
- Hot Swap Supplies
- RoHS Compliant



WDFN6 2x2, 0.65P  
CASE 511CY

### MARKING DIAGRAM

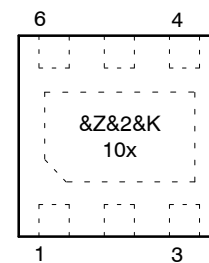

- &Z = Assembly Plant Code
- &2 = 2-Digit Date Code (Year and Week)
- &K = 2-Digit Lot Run Traceability Code
- 10x = Device Code (x = 5, 6)

### ORDERING INFORMATION

See detailed ordering and shipping information on page 2 of this data sheet.

# FPF1005 – FPF1006

## ORDERING INFORMATION

Part Number	Switch	Input Buffer	Output Discharge	ON Pin Activity	Package	Shipping <sup>†</sup>
FPF1005	55 mΩ, PMOS	Schmitt	NA	Active HIGH	(WDFN6), 2x2, 0.65P	3000 / Tape & Reel
FPF1006	55 mΩ, PMOS	Schmitt	120 Ω	Active HIGH	(WDFN6), 2x2, 0.65P	3000 / Tape & Reel

<sup>†</sup>For information on tape and reel specifications, including part orientation and tape sizes, please refer to our Tape and Reel Packaging Specifications Brochure, BRD8011/D.

## TYPICAL APPLICATION CIRCUIT

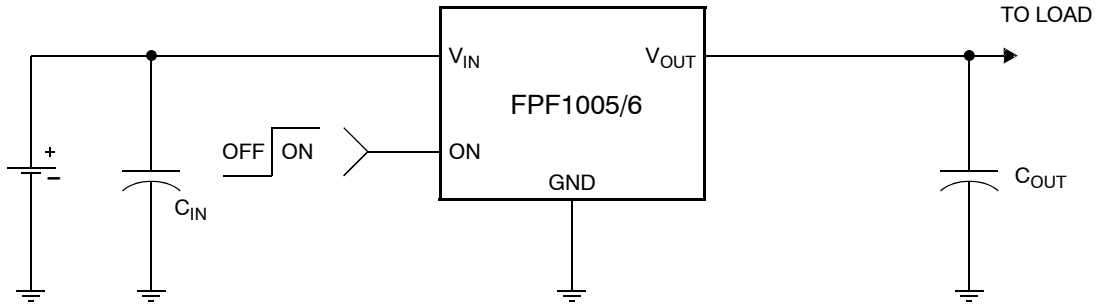

Figure 1. Typical Application Circuit

## FUNCTIONAL BLOCK DIAGRAM

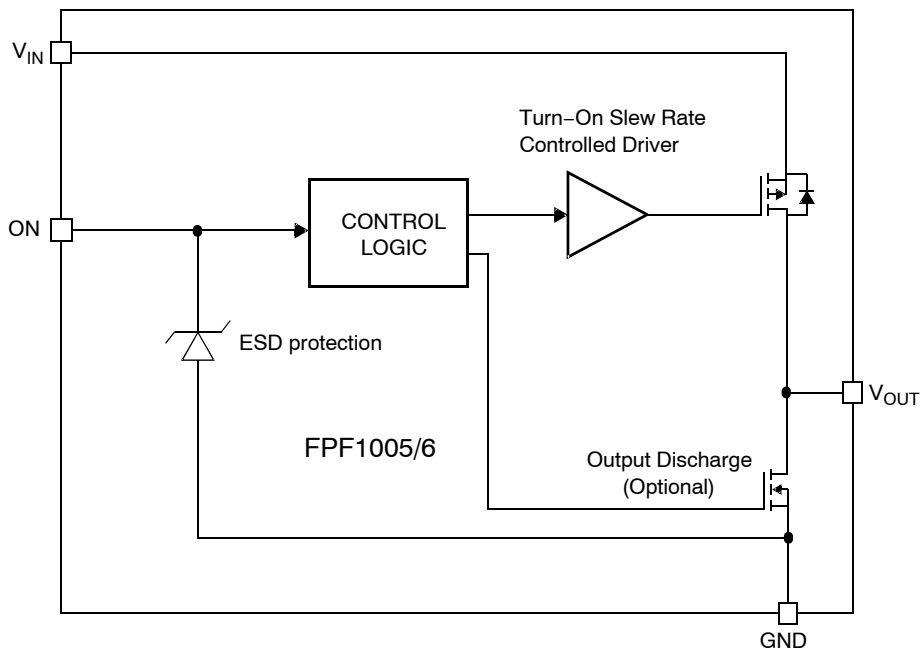
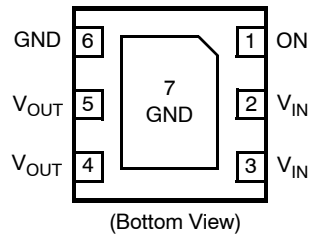

Figure 2. Functional Block Diagram

# FPF1005 – FPF1006

## PIN CONFIGURATION



**Figure 3. Pin Configuration**

### PIN DESCRIPTION

Pin	Name	Function
4, 5	V <sub>OUT</sub>	Switch Output: Output of the power switch
2, 3	V <sub>IN</sub>	Supply Input: Input to the power switch and the supply voltage for the IC
6, 7	GND	Ground
1	ON	ON/OFF Control Input

### ABSOLUTE MAXIMUM RATINGS

Parameter	Min	Max	Unit
V <sub>IN</sub> , V <sub>OUT</sub> , ON to GND	-0.3	6	V
Maximum Continuous Switch Current	-	1.5	A
Power Dissipation @ T <sub>A</sub> = 25°C (Note 1)	-	1.2	W
Operating Temperature Range	-40	85	°C
Storage Temperature	-65	150	°C
Thermal Resistance, Junction to Ambient	-	86	°C/W
Electrostatic Discharge Protection	HBM	2000	V
	MM	200	V

Stresses exceeding those listed in the Maximum Ratings table may damage the device. If any of these limits are exceeded, device functionality should not be assumed, damage may occur and reliability may be affected.

1. Package power dissipation on 1 square inch pad, 2 oz. copper board.

### RECOMMENDED OPERATING RANGE

Parameter	Min	Max	Unit
V <sub>IN</sub>	1.2	5.5	V
Ambient Operating Temperature, T <sub>A</sub>	-40	85	°C

Functional operation above the stresses listed in the Recommended Operating Ranges is not implied. Extended exposure to stresses beyond the Recommended Operating Ranges limits may affect device reliability.

## FPF1005 – FPF1006

**ELECTRICAL CHARACTERISTICS** ( $V_{IN} = 1.2$  to  $5.5$  V,  $T_A = -40$  to  $+85^\circ\text{C}$  unless otherwise noted. Typical values are at  $V_{IN} = 3.3$  V and  $T_A = 25^\circ\text{C}$ .)

Parameter	Symbol	Conditions	Min	Typ	Max	Unit
<b>BASIC OPERATION</b>						
Operating Voltage	$V_{IN}$		1.2	–	5.5	V
Quiescent Current	$I_Q$	$I_{OUT} = 0$ mA, $V_{IN} = V_{ON}$	–	–	1	$\mu\text{A}$
Off Supply Current	$I_{Q(off)}$	$V_{ON} = \text{GND}$ , $\text{OUT} = \text{open}$	–	–	1	$\mu\text{A}$
Off Switch Current	$I_{SD(off)}$	$V_{ON} = \text{GND}$ , $V_{OUT} = 0$ V, @ $V_{IN} = 5.5$ V, $T_A = 85^\circ\text{C}$	–	–	1	$\mu\text{A}$
		$V_{ON} = \text{GND}$ , $V_{OUT} = 0$ V, @ $V_{IN} = 3.3$ V, $T_A = 25^\circ\text{C}$	–	10	100	nA
On-Resistance	$R_{ON}$	$V_{IN} = 5.5$ V, $T_A = 25^\circ\text{C}$	–	50	70	m $\Omega$
		$V_{IN} = 3.3$ V, $T_A = 25^\circ\text{C}$	–	55	80	
		$V_{IN} = 1.5$ V, $T_A = 25^\circ\text{C}$	–	95	135	
		$V_{IN} = 1.2$ V, $T_A = 25^\circ\text{C}$	–	165	250	
Output Pull Down Resistance	$R_{PD}$	$V_{IN} = 3.3$ V, $V_{ON} = 0$ V, $T_A = 25^\circ\text{C}$ , FPF1006	–	75	120	$\Omega$
ON Input Logic Low Voltage	$V_{IL}$	$V_{IN} = 5.5$ V	–	–	1.25	V
		$V_{IN} = 4.5$ V	–	–	1.10	
		$V_{IN} = 1.5$ V	–	–	0.50	
ON Input Logic High Voltage	$V_{IH}$	$V_{IN} = 5.5$ V	2.00	–	–	V
		$V_{IN} = 4.5$ V	1.75	–	–	
		$V_{IN} = 1.5$ V	0.75	–	–	
ON Input Leakage		$V_{ON} = V_{IN}$ or $\text{GND}$	–1	–	1	$\mu\text{A}$

### DYNAMIC

Turn On Delay	$t_{ON}$	$V_{IN} = 3.3$ V, $R_L = 500$ $\Omega$ , $C_L = 0.1$ $\mu\text{F}$ , $T_A = 25^\circ\text{C}$	–	10	–	$\mu\text{s}$
Turn Off Delay	$t_{OFF}$	$V_{IN} = 3.3$ V, $R_L = 500$ $\Omega$ , $C_L = 0.1$ $\mu\text{F}$ , $T_A = 25^\circ\text{C}$ , FPF1005	–	50	–	$\mu\text{s}$
		$V_{IN} = 3.3$ V, $R_L = 500$ $\Omega$ , $C_L = 0.1$ $\mu\text{F}$ , $R_{L\_CHIP} = 120$ $\Omega$ , $T_A = 25^\circ\text{C}$ , FPF1006	–	10	–	
$V_{OUT}$ Rise Time	$t_R$	$V_{IN} = 3.3$ V, $R_L = 500$ $\Omega$ , $C_L = 0.1$ $\mu\text{F}$ , $T_A = 25^\circ\text{C}$	–	10	–	$\mu\text{s}$
$V_{OUT}$ Fall Time	$t_F$	$V_{IN} = 3.3$ V, $R_L = 500$ $\Omega$ , $C_L = 0.1$ $\mu\text{F}$ , $T_A = 25^\circ\text{C}$ , FPF1005	–	100	–	$\mu\text{s}$
		$V_{IN} = 3.3$ V, $R_L = 500$ $\Omega$ , $C_L = 0.1$ $\mu\text{F}$ , $R_{L\_CHIP} = 120$ $\Omega$ , $T_A = 25^\circ\text{C}$ , FPF1006	–	10	–	

Product parametric performance is indicated in the Electrical Characteristics for the listed test conditions, unless otherwise noted. Product performance may not be indicated by the Electrical Characteristics if operated under different conditions.

TYPICAL CHARACTERISTICS

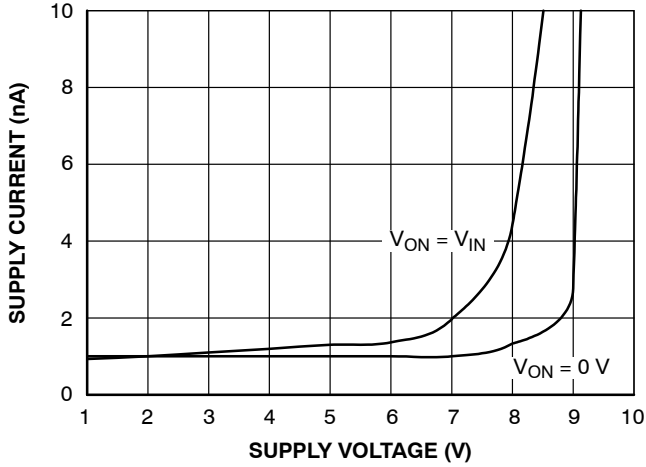

Figure 4. Quiescent Current vs.  $V_{IN}$

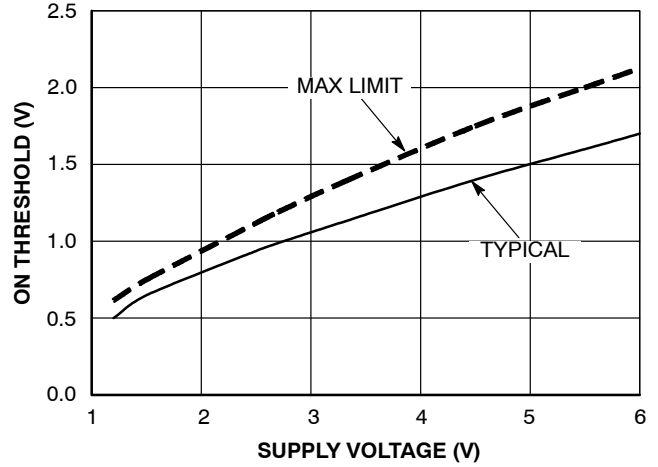

Figure 5. ON Threshold vs.  $V_{IN}$

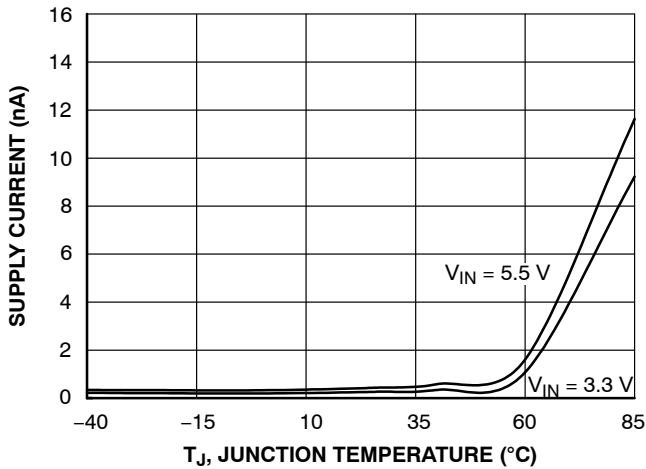

Figure 6. Quiescent Current vs. Temperature

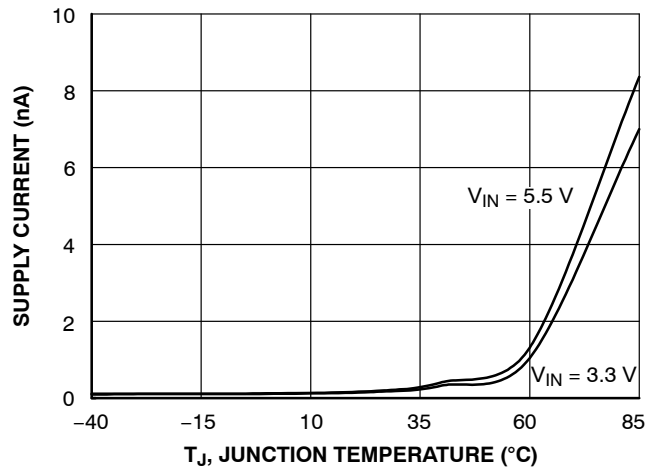

Figure 7. Quiescent Current (off) vs. Temperature

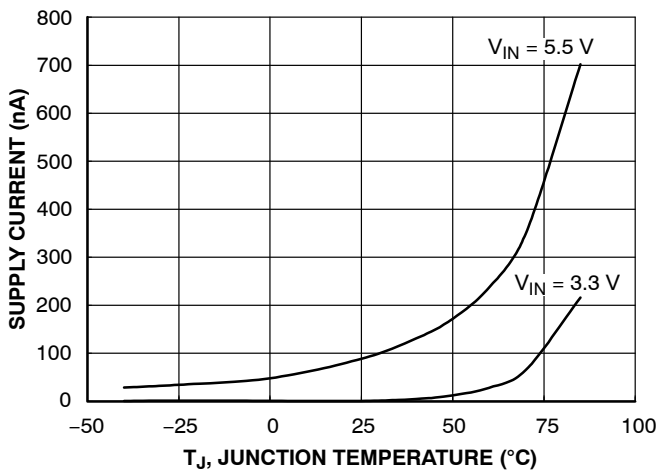

Figure 8.  $I_{SWITCH-OFF}$  Current vs. Temperature

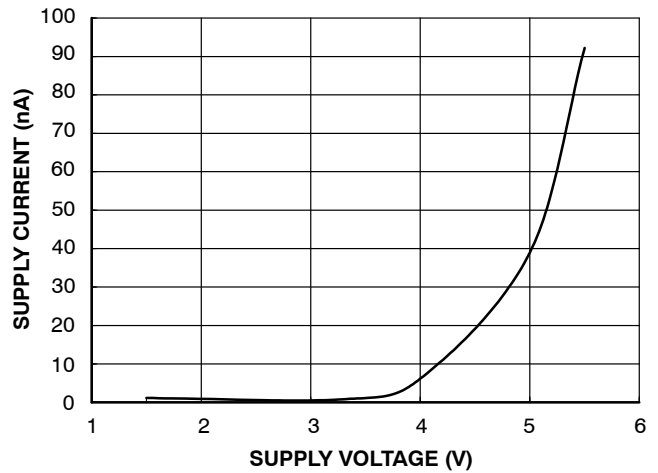

Figure 9.  $I_{SWITCH-OFF}$  Current vs.  $V_{IN}$

# FPF1005 – FPF1006

## TYPICAL CHARACTERISTICS (continued)

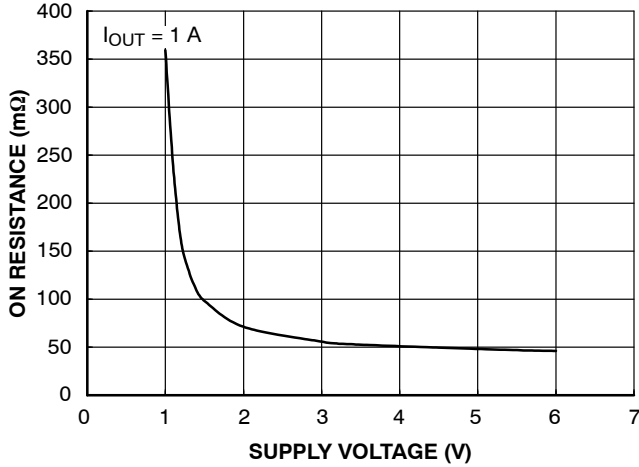

Figure 10.  $R_{ON}$  vs.  $V_{IN}$

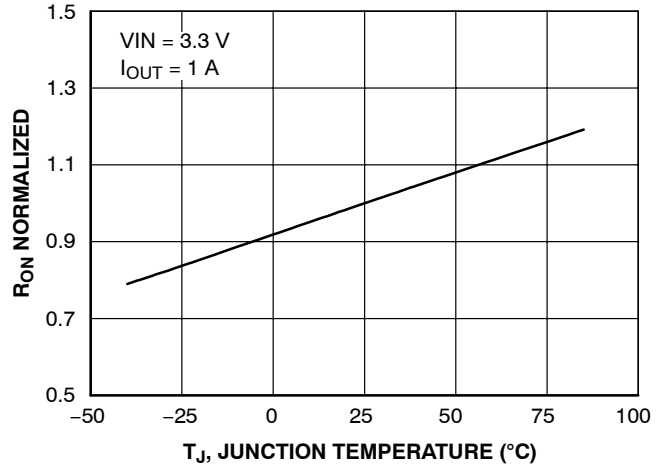

Figure 11.  $R_{ON}$  vs. Temperature

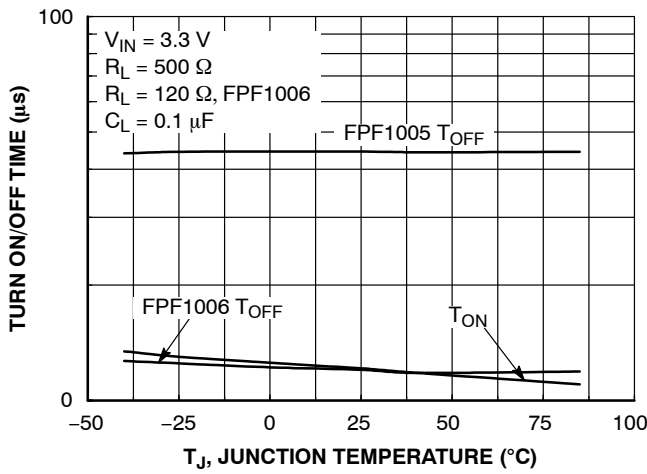

Figure 12.  $T_{ON}/T_{OFF}$  vs. Temperature

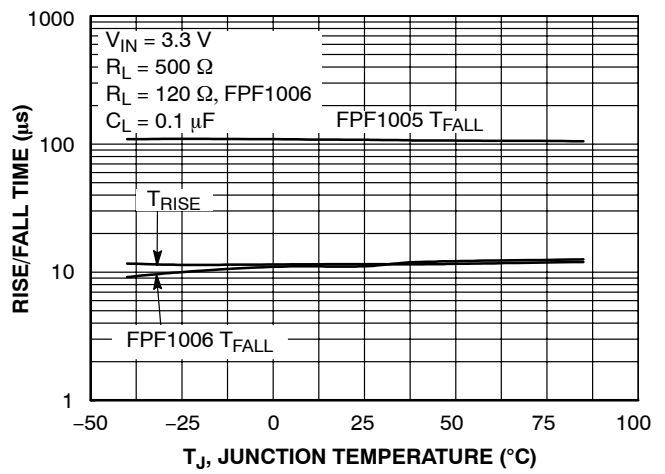

Figure 13.  $T_{RISE}/T_{FALL}$  vs. Temperature

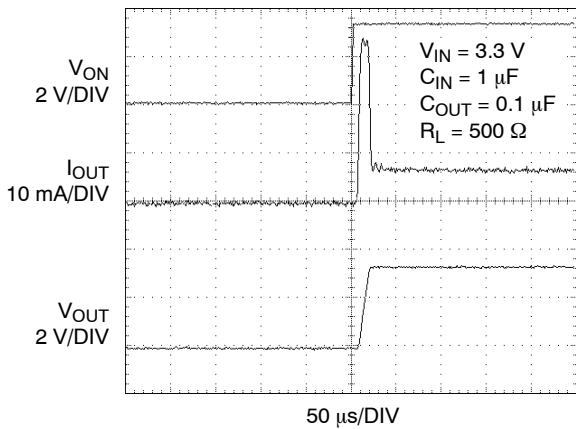

Figure 14. FPF1005  $T_{ON}$  Response

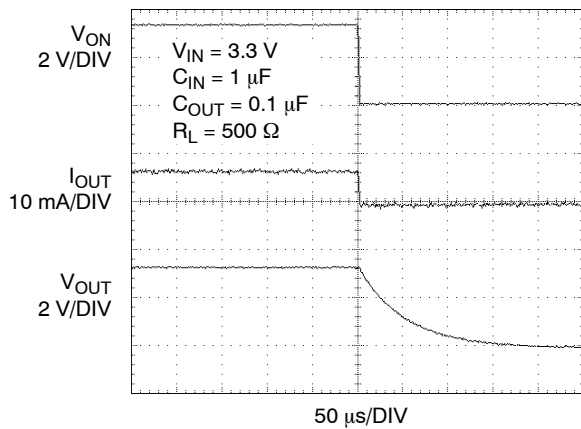

Figure 15. FPF1005  $T_{OFF}$  Response

# FPF1005 – FPF1006

## TYPICAL CHARACTERISTICS (continued)

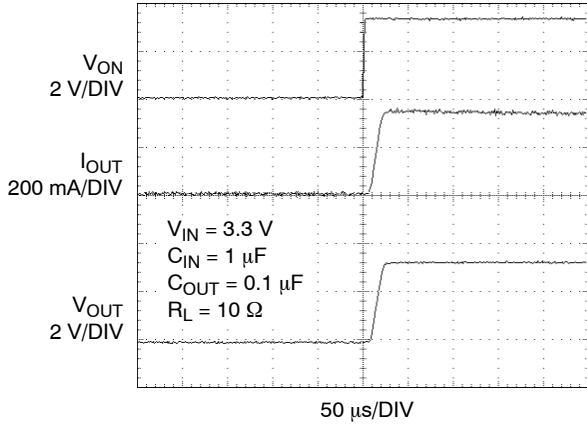

Figure 16. FPF1005  $T_{ON}$  Response

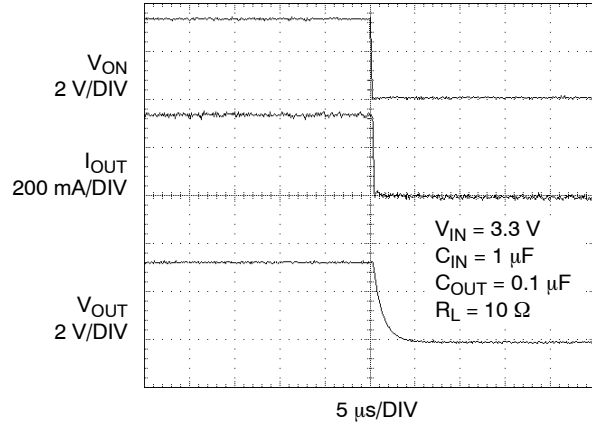

Figure 17. FPF1005  $T_{OFF}$  Response

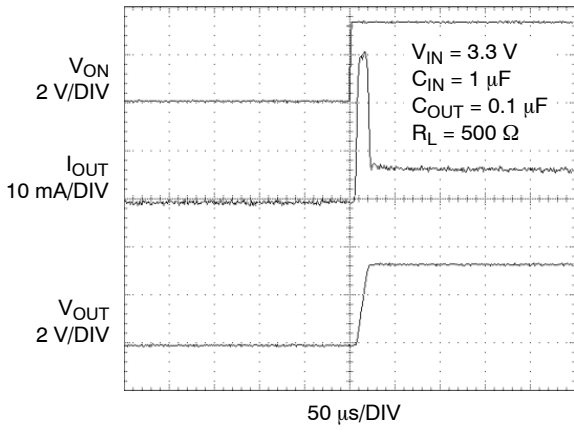

Figure 18. FPF1006  $T_{ON}$  Response

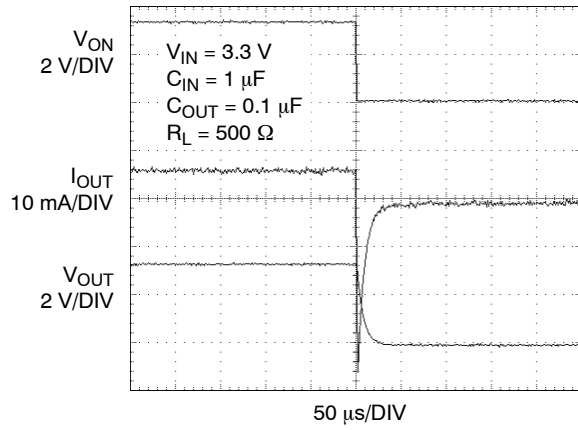

Figure 19. FPF1006  $T_{OFF}$  Response

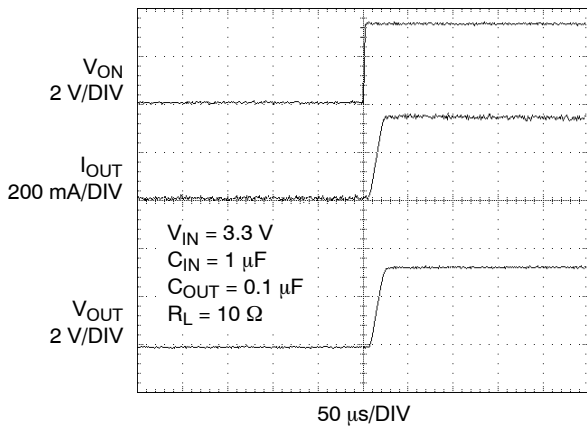

Figure 20. FPF1006  $T_{ON}$  Response

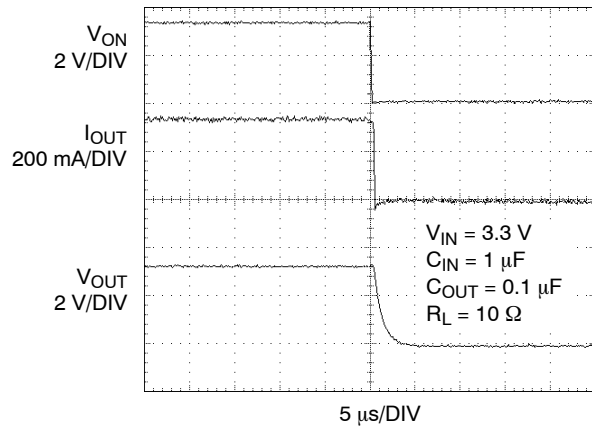

Figure 21. FPF1006  $T_{OFF}$  Response

# FPF1005 – FPF1006

## DESCRIPTION OF OPERATION

The FPF1005 & FPF1006 are low  $R_{DS(ON)}$  P-Channel load switches with controlled turn-on. The core of each device is a 55 m $\Omega$  P-Channel MOSFET and a controller capable of functioning over a wide input operating range of 1.2–5.5 V. The ON pin, an active HI TTL compatible input, controls the state of the switch. The FPF1006 contains a

120  $\Omega$  on-chip load resistor for quick output discharge when the switch is turned off.

However,  $V_{OUT}$  pin of FPF1006 should not be connected directly to the battery source due to the discharge mechanism of the load switch.

## APPLICATION INFORMATION

### Typical Application

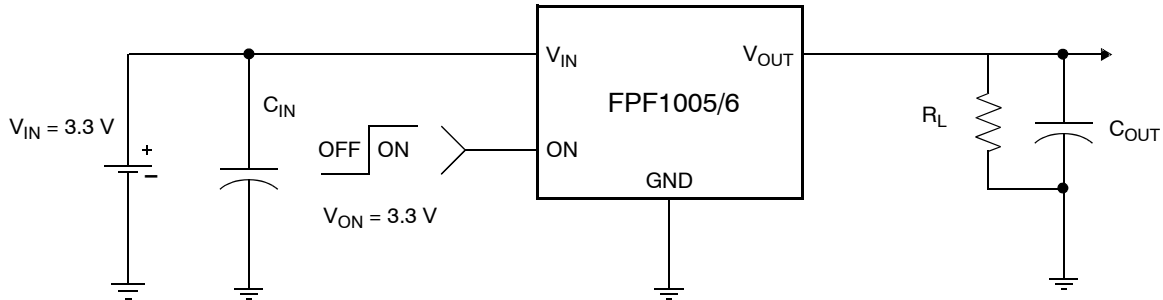

Figure 22. Typical Application

### Input Capacitor

To limit the voltage drop on the input supply caused by transient in-rush currents when the switch turns-on into a discharged load capacitor or a short-circuit, a capacitor needs to be placed between  $V_{IN}$  and GND. A 1  $\mu\text{F}$  ceramic capacitor,  $C_{IN}$ , placed close to the pins is usually sufficient. Higher values of  $C_{IN}$  can be used to further reduce the voltage drop during higher current application.

### Output Capacitor

A 0.1  $\mu\text{F}$  capacitor,  $C_{OUT}$ , should be placed between  $V_{OUT}$  and GND. This capacitor will prevent parasitic board inductance from forcing  $V_{OUT}$  below GND when the switch turns-off. Due to the integral body diode in the PMOS switch, a  $C_{IN}$  greater than  $C_{OUT}$  is highly recommended. A  $C_{OUT}$  greater than  $C_{IN}$  can cause  $V_{OUT}$  to exceed  $V_{IN}$  when the system supply is removed. This could result in current flow through the body diode from  $V_{OUT}$  to  $V_{IN}$ .

### Board Layout

For best performance, all traces should be as short as possible. To be most effective, the input and output capacitors should be placed close to the device to minimize the effects that parasitic trace inductance may have on normal and short-circuit operation. Using wide traces or large copper planes for all pins ( $V_{IN}$ ,  $V_{OUT}$ , ON and GND) will help minimize the parasitic electrical effects along with minimizing the case to ambient thermal impedance.

### Evaluation Board Layout

FPF1005/6 Demo board has the components and circuitry to demonstrate the load switch functions. Thermal performance of the load switch can be improved significantly by connecting the middle pad (pin 7) to the GND area of the PCB.

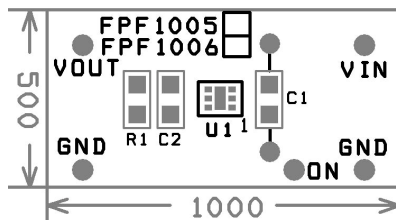

Figure 23. Demo Board Silk Screen Top and Component Assembly Drawing

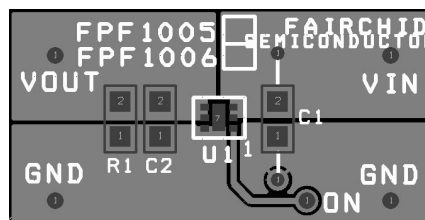

Figure 24. Demo Board Top and Surface Mount Top Layers View (Pin 7 is Connected to GND)

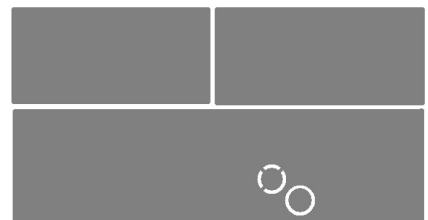

Figure 25. Demo Board Bottom Layer View



# MECHANICAL CASE OUTLINE

## PACKAGE DIMENSIONS

ON Semiconductor®



WDFN6 2x2, 0.65P  
CASE 511CY  
ISSUE O

DATE 31 JUL 2016

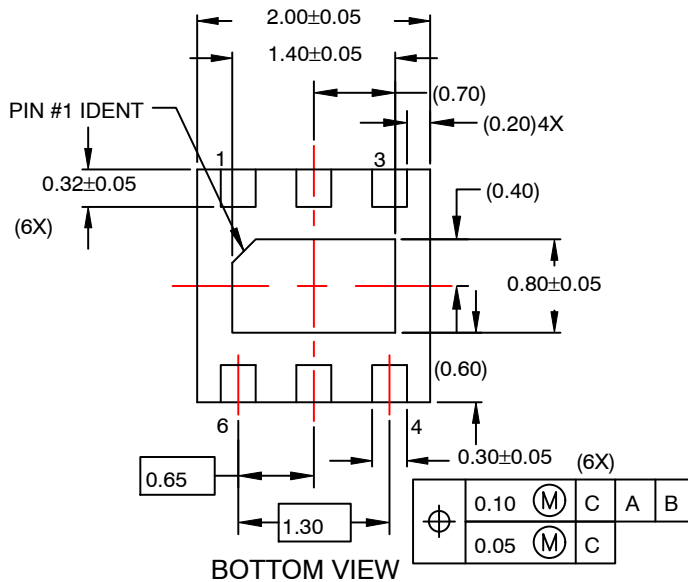
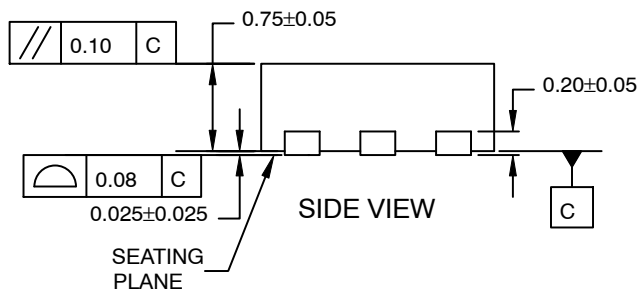
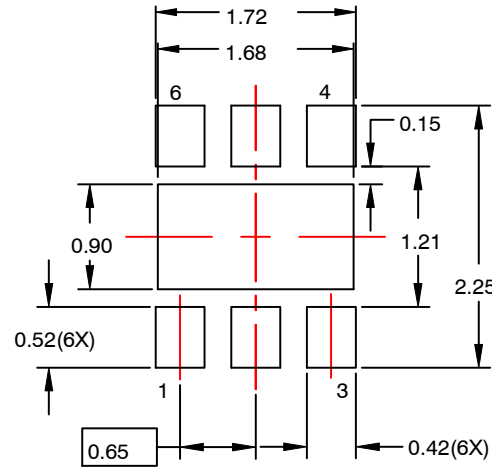
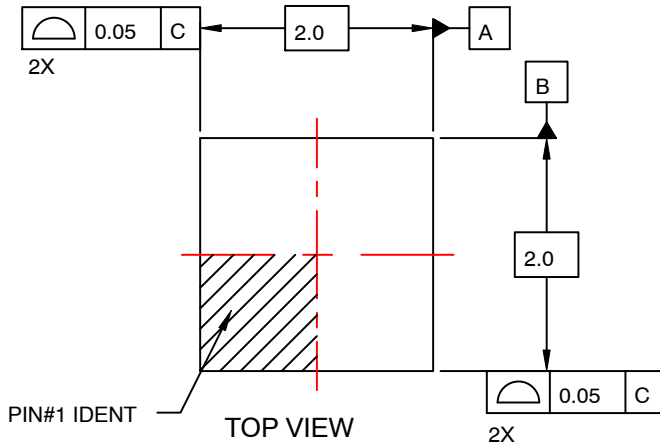

NOTES:

- A. PACKAGE DOES NOT FULLY CONFORM TO JEDEC MO-229 REGISTRATION
- B. DIMENSIONS ARE IN MILLIMETERS.
- C. DIMENSIONS AND TOLERANCES PER ASME Y14.5M, 2009.
- D. LAND PATTERN RECOMMENDATION IS EXISTING INDUSTRY LAND PATTERN.

<b>DOCUMENT NUMBER:</b>	<b>98AON13613G</b>	Electronic versions are uncontrolled except when accessed directly from the Document Repository. Printed versions are uncontrolled except when stamped "CONTROLLED COPY" in red.
<b>DESCRIPTION:</b>	<b>WDFN6 2X2, 0.65P</b>	<b>PAGE 1 OF 1</b>

ON Semiconductor and are trademarks of Semiconductor Components Industries, LLC dba ON Semiconductor or its subsidiaries in the United States and/or other countries. ON Semiconductor reserves the right to make changes without further notice to any products herein. ON Semiconductor makes no warranty, representation or guarantee regarding the suitability of its products for any particular purpose, nor does ON Semiconductor assume any liability arising out of the application or use of any product or circuit, and specifically disclaims any and all liability, including without limitation special, consequential or incidental damages. ON Semiconductor does not convey any license under its patent rights nor the rights of others.

**onsemi**, **Onsemi**, and other names, marks, and brands are registered and/or common law trademarks of Semiconductor Components Industries, LLC dba "**onsemi**" or its affiliates and/or subsidiaries in the United States and/or other countries. **onsemi** owns the rights to a number of patents, trademarks, copyrights, trade secrets, and other intellectual property. A listing of **onsemi**'s product/patent coverage may be accessed at [www.onsemi.com/site/pdf/Patent-Marking.pdf](http://www.onsemi.com/site/pdf/Patent-Marking.pdf). **onsemi** reserves the right to make changes at any time to any products or information herein, without notice. The information herein is provided "as-is" and **onsemi** makes no warranty, representation or guarantee regarding the accuracy of the information, product features, availability, functionality, or suitability of its products for any particular purpose, nor does **onsemi** assume any liability arising out of the application or use of any product or circuit, and specifically disclaims any and all liability, including without limitation special, consequential or incidental damages. Buyer is responsible for its products and applications using **onsemi** products, including compliance with all laws, regulations and safety requirements or standards, regardless of any support or applications information provided by **onsemi**. "Typical" parameters which may be provided in **onsemi** data sheets and/or specifications can and do vary in different applications and actual performance may vary over time. All operating parameters, including "Typicals" must be validated for each customer application by customer's technical experts. **onsemi** does not convey any license under any of its intellectual property rights nor the rights of others. **onsemi** products are not designed, intended, or authorized for use as a critical component in life support systems or any FDA Class 3 medical devices or medical devices with a same or similar classification in a foreign jurisdiction or any devices intended for implantation in the human body. Should Buyer purchase or use **onsemi** products for any such unintended or unauthorized application, Buyer shall indemnify and hold **onsemi** and its officers, employees, subsidiaries, affiliates, and distributors harmless against all claims, costs, damages, and expenses, and reasonable attorney fees arising out of, directly or indirectly, any claim of personal injury or death associated with such unintended or unauthorized use, even if such claim alleges that **onsemi** was negligent regarding the design or manufacture of the part. **onsemi** is an Equal Opportunity/Affirmative Action Employer. This literature is subject to all applicable copyright laws and is not for resale in any manner.

## ADDITIONAL INFORMATION

### TECHNICAL PUBLICATIONS:

Technical Library: [www.onsemi.com/design/resources/technical-documentation](http://www.onsemi.com/design/resources/technical-documentation)  
onsemi Website: [www.onsemi.com](http://www.onsemi.com)

### ONLINE SUPPORT: [www.onsemi.com/support](http://www.onsemi.com/support)

For additional information, please contact your local Sales Representative at [www.onsemi.com/support/sales](http://www.onsemi.com/support/sales)