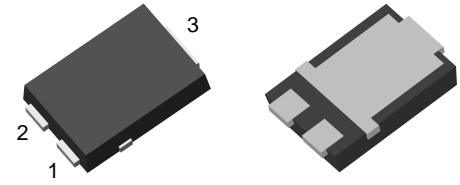
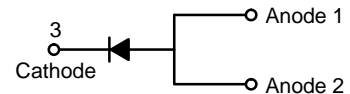
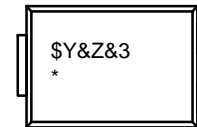

Ultrafast Rectifiers, Surface Mount, 6 A, 200 V - 600 V FES6, NRVFES6 Series

**TO-277-3LD
CASE 340BQ**
Features

- Very Low Profile: Typical Height of 1.1 mm
- Ultrafast Recovery Time
- Low Forward Voltage Drop
- Low Thermal Resistance
- Very Stable Operation at Industrial Temperature, 150°C
- RoHS Compliant
- Green Molding Compound as per IEC61249 Standard
- Lead Free in Compliance with EU RoHS 2011/65/EU Directive
- With DAP Option Only
- NRV Prefix for Automotive and Other Applications Requiring Unique Site and Control Change Requirements; AEC-Q101 Qualified and PPAP Capable

MARKING DIAGRAM

- \$Y = onsemi Logo
- &Z = Assembly Plant Code
- &3 = Date Code (Year & Week)
- * = Specific Device Code
FES6D, FES6G, FES6J

MAXIMUM RATINGS

Parameter	Symbol	Value	Unit
Repetitive Peak Reverse Voltage FES6D FES6G FES6J	V_{RRM}	200 400 600	V
Average Forward Rectified Current	$I_{F(AV)}$	6	A
Peak Forward Surge Current: 8.3 ms Single Half Sine-Wave Superimposed on Rated Load	I_{FSM}	80	A
Operating Junction Temperature Range	T_J	-55 to +175	°C
Storage Temperature Range	T_{STG}	-55 to +175	°C

Stresses exceeding those listed in the Maximum Ratings table may damage the device. If any of these limits are exceeded, device functionality should not be assumed, damage may occur and reliability may be affected.

ORDERING INFORMATION

Part Number	Top Mark	Package	Shipping†
FES6D	FES6D	TO-277 3L (with DAP Option only)	5000 / Tape & Reel
FES6G	FES6G		
NRVFES6G*			
FES6J	FES6J		
NRVFES6J*			

DISCONTINUED (Note 1)

NRVFES6D*	FES6D	TO-277 3L (with DAP Option only)	5000 / Tape & Reel
-----------	-------	----------------------------------	--------------------

†For information on tape and reel specifications, including part orientation and tape sizes, please refer to our Tape and Reel Packaging Specifications Brochure, BRD8011/D.

*NRV Prefix for Automotive and Other Applications Requiring Unique Site and Control Change Requirements; AEC-Q101 Qualified and PPAP Capable.

1. **DISCONTINUED:** This device is not recommended for new design. Please contact your onsemi representative for information. The most current information on this device may be available on www.onsemi.com.

FES6, NRVFES6 Series

THERMAL CHARACTERISTICS (Values are at $T_A = 25^\circ\text{C}$ unless otherwise noted) (Note 2)

Parameter	Symbol	Value	Unit
Thermal Characteristics, Junction-to-Lead, Thermocouple Soldered to Cathode	Ψ_{JL}	6	$^\circ\text{C/W}$
Thermal Resistance, Junction-to-Ambient	$R_{\theta JA}$	100	$^\circ\text{C/W}$

2. Per JESD51-3 Recommended Thermal Test Board.

ELECTRICAL CHARACTERISTICS (Values are at $T_A = 25^\circ\text{C}$ unless otherwise noted)

Symbol	Parameter	Conditions	Value			Unit
			FES6D	FES6G	FES6J	
V_F	Maximum Instantaneous Forward Voltage (Note 3)	$I_F = 6\text{ A}$	1.05	1.20	2.2	V
		$I_F = 6\text{ A}, T_J = 125^\circ\text{C}$	0.90	1.00	1.80	
I_R	Maximum Reverse Current at Rated V_R	$T_J = 25^\circ\text{C}$	2			μA
		$T_J = 125^\circ\text{C}$	200	500		
C_J	Typical Junction Capacitance	$V_R = 4\text{ V}, f = 1\text{ MHz}$	60		45	pF
T_{rr}	Typical Reverse Recovery Time	$I_F = 0.5\text{ A}, I_R = 1\text{ A}, I_{RR} = 0.25\text{ A}$	25			ns
		$I_F = 1\text{ A}, di/dt = 50\text{ A}/\mu\text{s}, V_R = 30\text{ V}$	45			

Product parametric performance is indicated in the Electrical Characteristics for the listed test conditions, unless otherwise noted. Product performance may not be indicated by the Electrical Characteristics if operated under different conditions.

3. Pulse test with $PW = 300\ \mu\text{s}$, 1% duty cycle

FES6, NRVFES6 Series

TYPICAL CHARACTERISTICS

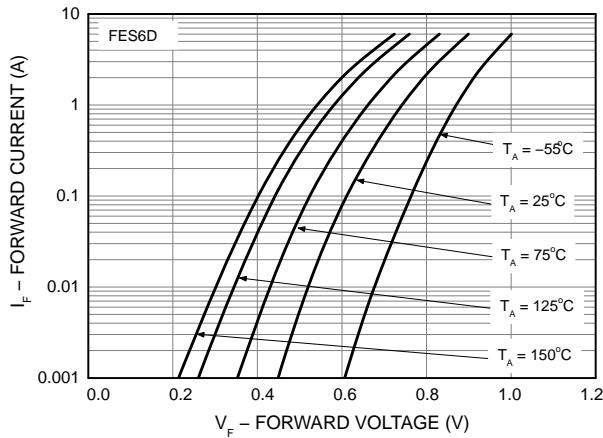

Fig 1. Typical Forward Characteristics for FES6D

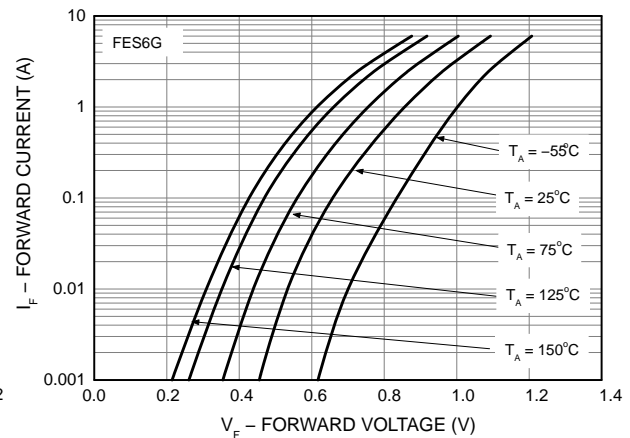

Fig 2. Typical Forward Characteristics for FES6G

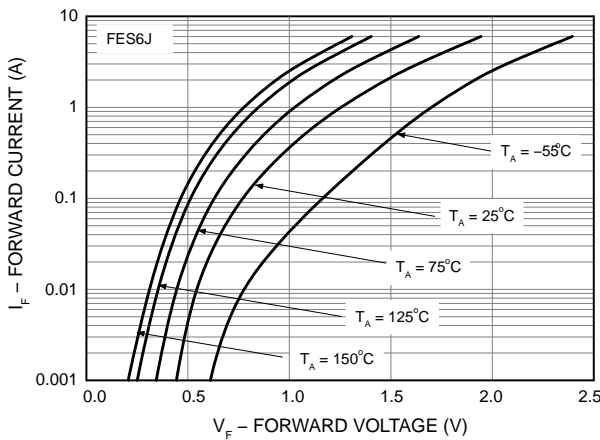

Fig 3. Typical Forward Characteristics for FES6J

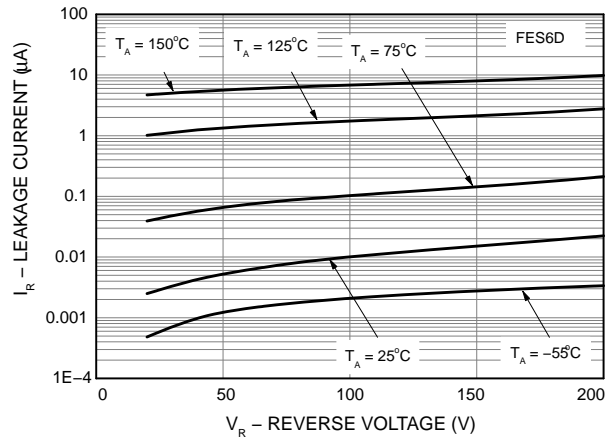

Fig 4. Typical Reverse Characteristics for FES6D

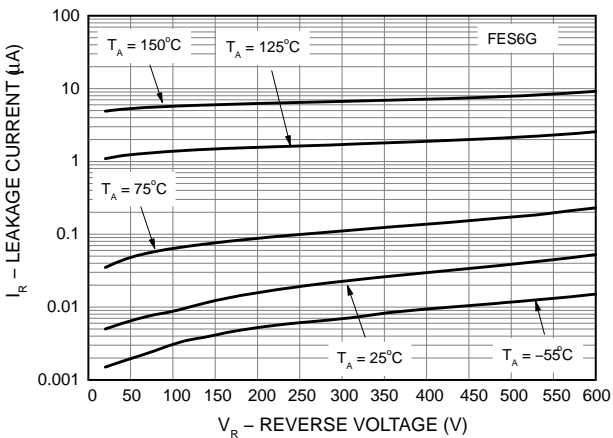

Fig 5. Typical Reverse Characteristics for FES6G

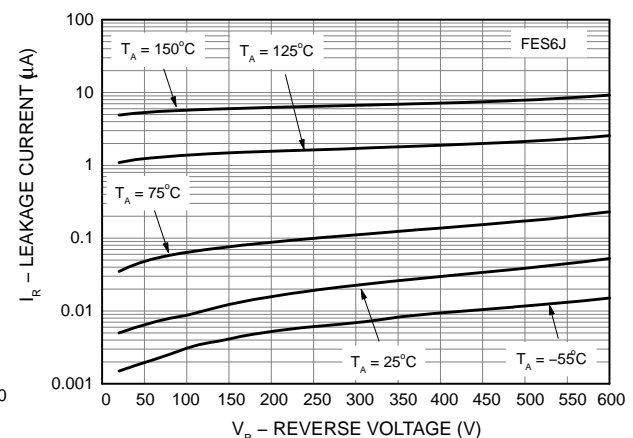

Fig 6. Typical Reverse Characteristics for FES6J

FES6, NRVFES6 Series

TYPICAL CHARACTERISTICS

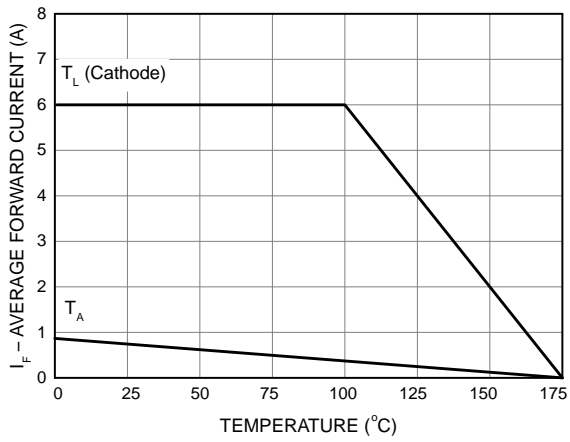

Fig 7. Forward Current Derating Curve

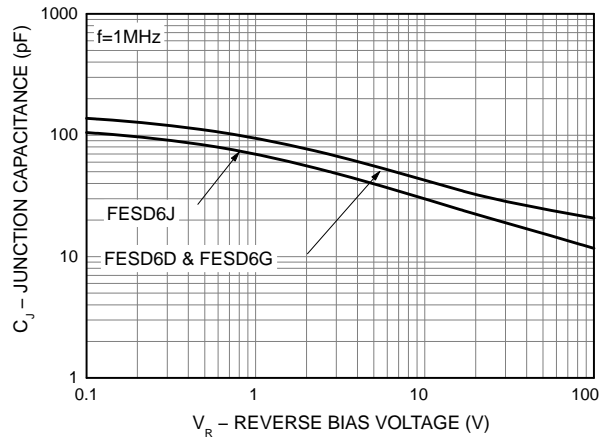
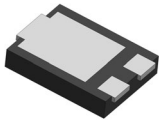

Fig 8. Typical Junction Capacitance



TO-277-3 5.91x4.44x1.10, 2.10P
CASE 340BQ
ISSUE A

DATE 16 APR 2026

NOTES:

1. DIMENSIONING AND TOLERANCING AS PER ASME Y14.5M, 2018.
2. CONTROLLING DIMENSION: MILLIMETERS.
3. DIMENSIONS D1 AND E1 DO NOT INCLUDE MOLD FLASH, MOLD FLASH SHALL NOT EXCEED 0.13 mm PER SIDE.

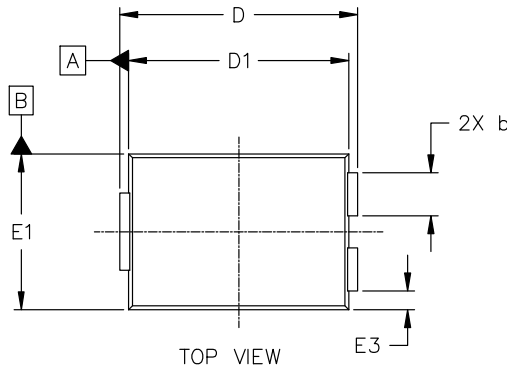

TOP VIEW

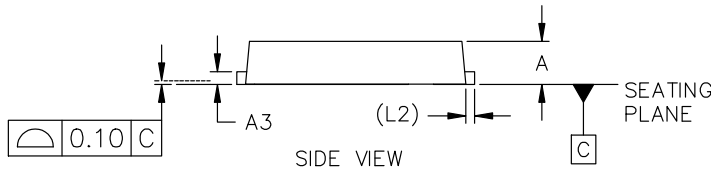

SIDE VIEW

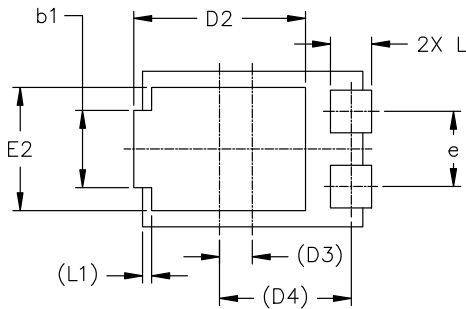

BOTTOM VIEW

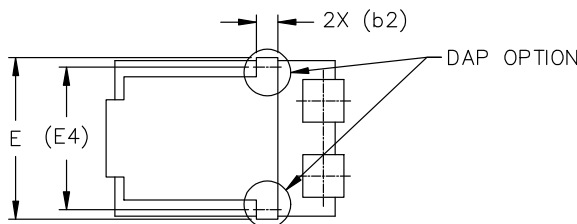

BOTTOM VIEW - DAP OPTION

MILLIMETERS			
DIM	MIN	NOM	MAX
A	1.00	1.10	1.20
A3	0.23	0.32	0.40
b	1.10	1.25	1.40
b1	1.95	2.10	2.25
b2	0.60 REF		
D	6.35	6.50	6.65
D1	5.67	5.91	6.15
D2	4.23	4.57	4.90
D3	0.913 REF		
D4	3.680 REF		
E	---	---	4.75
E1	4.25	4.44	4.63
E2	3.25	3.48	3.70
E3	0.43	0.53	0.63
E4	3.680 REF		
e	2.00	2.10	2.20
L	0.90	1.08	1.25
L1	0.25 REF		
L2	0.35 REF		

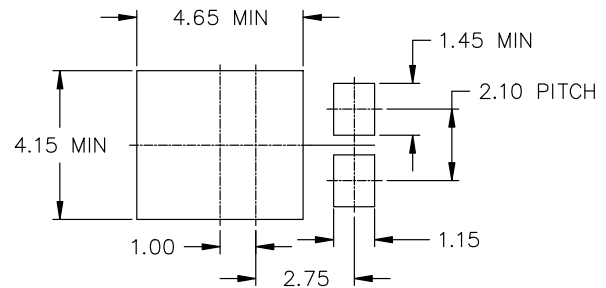

RECOMMENDED MOUNTING FOOTPRINT

*For additional information on our Pb-Free strategy and soldering details, please download the onsemi Soldering and Mounting Techniques Reference Manual, SOLDERRM/D.

DOCUMENT NUMBER:	98AON13861G	Electronic versions are uncontrolled except when accessed directly from the Document Repository. Printed versions are uncontrolled except when stamped "CONTROLLED COPY" in red.
DESCRIPTION:	TO-277-3 5.91x4.44x1.10, 2.10P	PAGE 1 OF 1

onsemi and Onsemi are trademarks of Semiconductor Components Industries, LLC dba onsemi or its subsidiaries in the United States and/or other countries. onsemi reserves the right to make changes without further notice to any products herein. onsemi makes no warranty, representation or guarantee regarding the suitability of its products for any particular purpose, nor does onsemi assume any liability arising out of the application or use of any product or circuit, and specifically disclaims any and all liability, including without limitation special, consequential or incidental damages. onsemi does not convey any license under its patent rights nor the rights of others.

onsemi, **Onsemi**, and other names, marks, and brands are registered and/or common law trademarks of Semiconductor Components Industries, LLC dba "**onsemi**" or its affiliates and/or subsidiaries in the United States and/or other countries. **onsemi** owns the rights to a number of patents, trademarks, copyrights, trade secrets, and other intellectual property. A listing of **onsemi**'s product/patent coverage may be accessed at www.onsemi.com/site/pdf/Patent-Marking.pdf. **onsemi** reserves the right to make changes at any time to any products or information herein, without notice. The information herein is provided "as-is" and **onsemi** makes no warranty, representation or guarantee regarding the accuracy of the information, product features, availability, functionality, or suitability of its products for any particular purpose, nor does **onsemi** assume any liability arising out of the application or use of any product or circuit, and specifically disclaims any and all liability, including without limitation special, consequential or incidental damages. Buyer is responsible for its products and applications using **onsemi** products, including compliance with all laws, regulations and safety requirements or standards, regardless of any support or applications information provided by **onsemi**. "Typical" parameters which may be provided in **onsemi** data sheets and/or specifications can and do vary in different applications and actual performance may vary over time. All operating parameters, including "Typicals" must be validated for each customer application by customer's technical experts. **onsemi** does not convey any license under any of its intellectual property rights nor the rights of others. **onsemi** products are not designed, intended, or authorized for use as a critical component in life support systems or any FDA Class 3 medical devices or medical devices with a same or similar classification in a foreign jurisdiction or any devices intended for implantation in the human body. Should Buyer purchase or use **onsemi** products for any such unintended or unauthorized application, Buyer shall indemnify and hold **onsemi** and its officers, employees, subsidiaries, affiliates, and distributors harmless against all claims, costs, damages, and expenses, and reasonable attorney fees arising out of, directly or indirectly, any claim of personal injury or death associated with such unintended or unauthorized use, even if such claim alleges that **onsemi** was negligent regarding the design or manufacture of the part. **onsemi** is an Equal Opportunity/Affirmative Action Employer. This literature is subject to all applicable copyright laws and is not for resale in any manner.

ADDITIONAL INFORMATION

TECHNICAL PUBLICATIONS:

Technical Library: www.onsemi.com/design/resources/technical-documentation
onsemi Website: www.onsemi.com

ONLINE SUPPORT: www.onsemi.com/support

For additional information, please contact your local Sales Representative at www.onsemi.com/support/sales