

Field Stop Trench IGBT With Soft Fast Recovery Diode and $V_{CE(sat)}$, V_{TH} Binning

650 V, 160 A

AFGY160T65SPD-B4

Features

- AEC-Q101 Qualified and PPAP Capable
- Very Low Saturation Voltage: $V_{CE(sat)} = 1.6$ V (Typ.) @ $I_C = 160$ A
- Maximum Junction Temperature: $T_J = 175^\circ\text{C}$
- Positive Temperature Co-Efficient
- Tight Parameter Distribution
- High Input Impedance
- 100% of the Parts are Dynamically Tested
- Short Circuit Ruggedness $> 6 \mu\text{s}$ @ 25°C
- Copacked with Soft, Fast Recovery Extremefast Diode
- This Device is Pb-Free, Halogen Free/BFR Free and are RoHS Compliant

Benefits

- Very Low Conduction and Switching Losses for a High Efficiency Operation in Various Applications
- Rugged Transient Reliability
- Outstanding Parallel Operation Performance with Balance Current Sharing
- Low EMI

Applications

- Traction Inverter for HEV/EV
- Auxiliary DC/AC Converter
- Motor Drives
- Other Power-Train Applications Requiring High Power Switch



ON Semiconductor®

www.onsemi.com

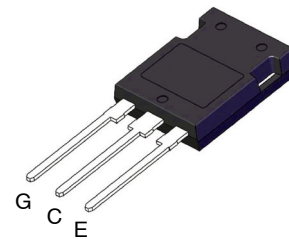
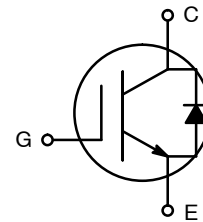

TO-247-3LD
CASE 340CU

MARKING DIAGRAM

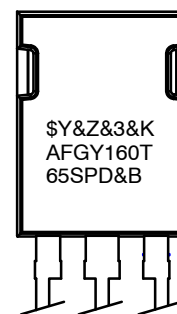

\$Y	= ON Semiconductor Logo
&Z	= Assembly Plant Code
&3	= Date Code (Year & Week)
&K	= Lot Traceability Code
AFGY160T65SPD	= Specific Device Code
&B	= BIN Designator

ORDERING INFORMATION

See detailed ordering and shipping information in the package dimensions section on page 2 of this data sheet.

AFGY160T65SPD-B4

ABSOLUTE MAXIMUM RATINGS

Symbol	Parameter	Ratings	Unit
V_{CES}	Collector to Emitter Voltage	650	V
V_{GES}	Gate to Emitter Voltage	± 20	V
	Transient Gate to Emitter Voltage	± 30	V
I_C	Collector Current @ $T_C = 25^\circ\text{C}$ (Note 1)	240	A
	Collector Current @ $T_C = 100^\circ\text{C}$	220	A
$I_{Nominal}$	Nominal Current	160	A
I_{CM}	Pulsed Collector Current	480	A
I_{FM}	Diode Forward Current @ $T_C = 25^\circ\text{C}$ (Note 1)	240	A
	Diode Forward Current @ $T_C = 100^\circ\text{C}$	188	A
P_D	Maximum Power Dissipation @ $T_C = 25^\circ\text{C}$	882	W
	Maximum Power Dissipation @ $T_C = 100^\circ\text{C}$	441	W
SCWT	Short Circuit Withstand Time @ $T_C = 25^\circ\text{C}$	6	μs
$\Delta V/\Delta t$	Voltage Transient Ruggedness (Note 2)	10	V/ns
T_J	Operating Junction Temperature	-55 to +175	$^\circ\text{C}$
T_{stg}	Storage Temperature Range	-55 to +175	$^\circ\text{C}$
T_L	Maximum Lead Temp. for soldering Purposes, 1/8" from case for 5 seconds	300	$^\circ\text{C}$

Stresses exceeding those listed in the Maximum Ratings table may damage the device. If any of these limits are exceeded, device functionality should not be assumed, damage may occur and reliability may be affected.

1. Limited to bondwire.
2. $V_{CC} = 400\text{ V}$, $V_{GE} = 15\text{ V}$, $I_{CE} = 480\text{ A}$, Inductive load.

THERMAL CHARACTERISTICS

Symbol	Parameter	Typ.	Max.	Units
$R_{\theta JC}$ (IGBT)	Thermal Resistance, Junction to Case	-	0.17	$^\circ\text{C}/\text{W}$
$R_{\theta JC}$ (Diode)	Thermal Resistance, Junction to Case	-	0.32	$^\circ\text{C}/\text{W}$
$R_{\theta JA}$	Thermal Resistance, Junction to Ambient	-	40	$^\circ\text{C}/\text{W}$

PACKAGE MARKING AND ORDERING INFORMATION

Device Marking	Device	Bin Designator	Packing Type	Qty per Tube/Reel*
AFGY160T65SPDA	AFGY160T65SPD-B4	A	Tube	30
AFGY160T65SPDB	AFGY160T65SPD-B4	B	Tube	30
AFGY160T65SPDC	AFGY160T65SPD-B4	C	Tube	30
AFGY160T65SPDD	AFGY160T65SPD-B4	D	Tube	30

*Generally all tubes in one box will belong to the same bin. In rare and unusual cases there may be tubes from more than one bin inside one box. Such mixing would not be considered a quality excursion.

The primary container quantity (MPQ) for these binning products is 30 units and therefore partial box shipment can be expected.

AFGY160T65SPD-B4

ELECTRICAL CHARACTERISTICS OF THE IGBT ($T_J = 25^\circ\text{C}$ unless otherwise noted)

Symbol	Parameter	Test Conditions	Min.	Typ.	Max.	Unit
--------	-----------	-----------------	------	------	------	------

OFF CHARACTERISTICS

BV_{CES}	Collector to Emitter Breakdown Voltage	$V_{GE} = 0\text{ V}, I_C = 1\text{ mA}$	650	-	-	V
$\frac{\Delta BV_{CES}}{\Delta T_J}$	Temperature Coefficient of Breakdown Voltage	$V_{GE} = 0\text{ V}, I_C = 1\text{ mA}$	-	0.6	-	$\text{V}/^\circ\text{C}$
I_{CES}	Collector Cut-Off Current	$V_{CE} = V_{CES}, V_{GE} = 0\text{ V}$	-	-	40	μA
I_{GES}	G-E Leakage Current	$V_{GE} = V_{GES}, V_{CE} = 0\text{ V}$	-	-	± 250	nA

ON CHARACTERISTICS

$V_{GE(th)A}$	G-E Threshold (Bin A)	$I_C = 160\text{ mA}; V_{CE} = V_{GE}$	5.15	5.5	6.3	V
$V_{CE(sat)A}$	Collector to Emitter Saturation Voltage (Bin A)	$I_C = 160\text{ A}; V_{GE} = 15\text{ V}$	1.5	1.6	1.67	V
$V_{GE(th)B}$	G-E Threshold (Bin B)	$I_C = 160\text{ mA}; V_{CE} = V_{GE}$	5.15	5.5	6.3	V
$V_{CE(sat)B}$	Collector to Emitter Saturation Voltage (Bin B)	$I_C = 160\text{ A}; V_{GE} = 15\text{ V}$	1.57	1.64	2.05	V
$V_{GE(th)C}$	G-E Threshold (Bin C)	$I_C = 160\text{ mA}; V_{CE} = V_{GE}$	4.3	5.3	5.65	V
$V_{CE(sat)C}$	Collector to Emitter Saturation Voltage (Bin C)	$I_C = 160\text{ A}; V_{GE} = 15\text{ V}$	1.5	1.6	1.67	V
$V_{GE(th)D}$	G-E Threshold (Bin D)	$I_C = 160\text{ mA}; V_{CE} = V_{GE}$	4.3	5.3	5.65	V
$V_{CE(sat)D}$	Collector to Emitter Saturation Voltage (Bin D)	$I_C = 160\text{ A}; V_{GE} = 15\text{ V}$	1.57	1.64	2.05	V
$V_{GE(th)}$	G-E Threshold	$I_C = 160\text{ mA}; V_{CE} = V_{GE}$	4.3	5.3	6.3	V
$V_{CE(sat)}$	Collector to Emitter Saturation Voltage	$I_C = 160\text{ A}; V_{GE} = 15\text{ V}$	-	1.6	2.05	V
		$I_C = 160\text{ A}; V_{GE} = 15\text{ V}; T_J = 175^\circ\text{C}$	-	2.15	-	V

DYNAMIC CHARACTERISTICS

C_{ies}	Input Capacitance	$V_{CE} = 30\text{ V}, V_{GE} = 0\text{ V}, f = 1\text{ MHz}$	-	6710	-	pF
C_{oes}	Output Capacitance		-	450	-	pF
C_{res}	Reverse Transfer Capacitance		-	55	-	pF
R_G	Internal Gate Resistance	$f = 1\text{ MHz}$	-	3	-	Ω

SWITCHING CHARACTERISTICS

$T_{d(on)}$	Turn-On Delay Time	$V_{CC} = 400\text{ V}, I_C = 160\text{ A}, R_G = 5\ \Omega, V_{GE} = 15\text{ V}, \text{Inductive Load}, T_J = 25^\circ\text{C}$	-	53	-	ns
T_r	Rise Time		-	197	-	ns
$T_{d(off)}$	Turn-Off Delay Time		-	98	-	ns
T_f	Fall Time		-	141	-	ns
E_{on}	Turn-On Switching Loss		-	12.4	-	mJ
E_{off}	Turn-Off Switching Loss		-	5.7	-	mJ
E_{ts}	Total Switching Loss		-	18.1	-	mJ
$T_{d(on)}$	Turn-On Delay Time	$V_{CC} = 400\text{ V}, I_C = 160\text{ A}, R_G = 5\ \Omega, V_{GE} = 15\text{ V}, \text{Inductive Load}, T_J = 175^\circ\text{C}$	-	52	-	ns
T_r	Rise Time		-	236	-	ns
$T_{d(off)}$	Turn-Off Delay Time		-	104	-	ns
T_f	Fall Time		-	204	-	ns
E_{on}	Turn-On Switching Loss		-	21	-	mJ
E_{off}	Turn-Off Switching Loss		-	8.5	-	mJ
E_{ts}	Total Switching Loss		-	29.5	-	mJ

AFGY160T65SPD-B4

ELECTRICAL CHARACTERISTICS OF THE IGBT ($T_J = 25^\circ\text{C}$ unless otherwise noted) (continued)

Symbol	Parameter	Test Conditions	Min.	Typ.	Max.	Unit
SWITCHING CHARACTERISTICS						
Q_g	Total Gate Charge	$V_{CE} = 400\text{ V}$, $I_C = 160\text{ A}$, $V_{GE} = 15\text{ V}$	-	163	245	nC
Q_{ge}	Gate to Emitter Charge		-	50	-	nC
Q_{gc}	Gate to Collector Charge		-	49	-	nC

Product parametric performance is indicated in the Electrical Characteristics for the listed test conditions, unless otherwise noted. Product performance may not be indicated by the Electrical Characteristics if operated under different conditions.

ELECTRICAL CHARACTERISTICS OF THE DIODE ($T_J = 25^\circ\text{C}$ unless otherwise noted)

Symbol	Parameter	Test Conditions	Min.	Typ.	Max.	Unit	
V_{FM}	Diode Forward Voltage	$I_F = 160\text{ A}$	$T_J = 25^\circ\text{C}$	-	1.4	1.7	V
			$T_J = 175^\circ\text{C}$	-	1.35	-	
E_{rec}	Reverse Recovery Energy	$V_{CE} = 400\text{ V}$, $I_F = 160\text{ A}$, $\Delta I_F/\Delta t = 1000\text{ A}/\mu\text{s}$	$T_J = 25^\circ\text{C}$	-	598	-	μJ
			$T_J = 175^\circ\text{C}$	-	4000	-	
T_{rr}	Diode Reverse Recovery Time		$T_J = 25^\circ\text{C}$	-	132	-	ns
			$T_J = 175^\circ\text{C}$	-	245	-	
Q_{rr}	Diode Reverse Recovery Charge		$T_J = 25^\circ\text{C}$	-	3.3	-	μC
			$T_J = 175^\circ\text{C}$	-	12.5	-	

Product parametric performance is indicated in the Electrical Characteristics for the listed test conditions, unless otherwise noted. Product performance may not be indicated by the Electrical Characteristics if operated under different conditions.

TYPICAL PERFORMANCE CHARACTERISTICS

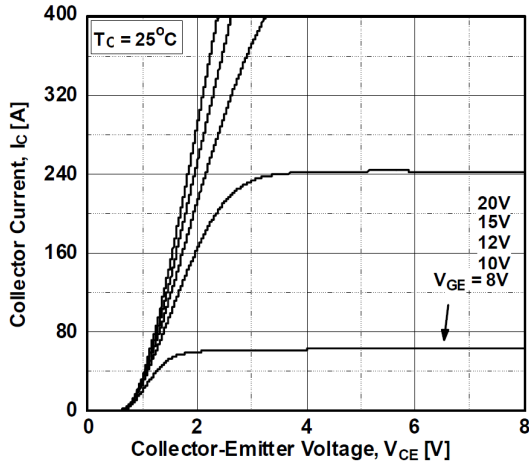

Figure 1. Typical Output Characteristics

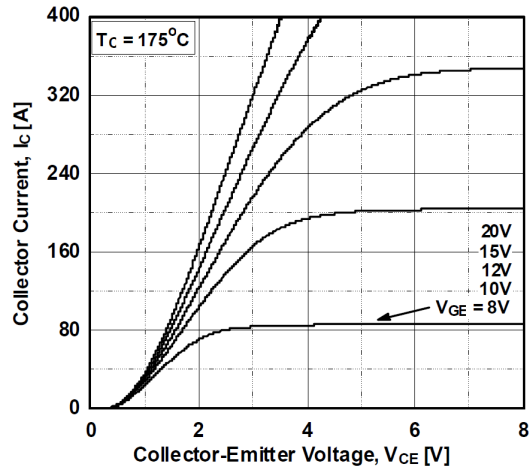

Figure 2. Typical Output Characteristics

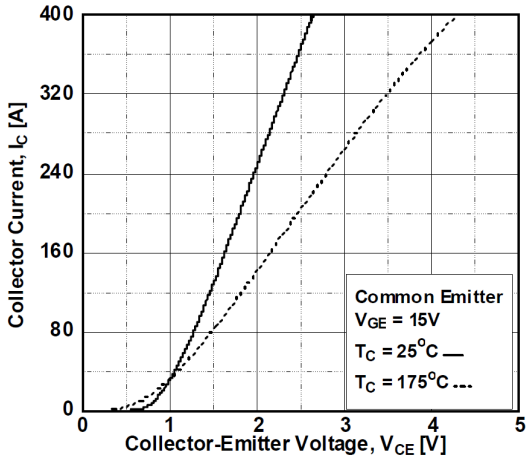

Figure 3. Typical Saturation Voltage Characteristics

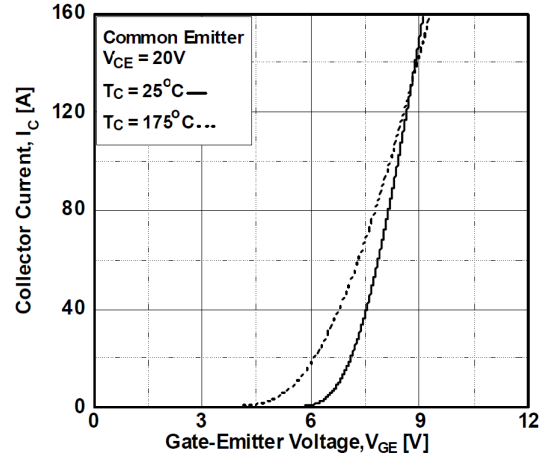

Figure 4. Transfer Characteristics

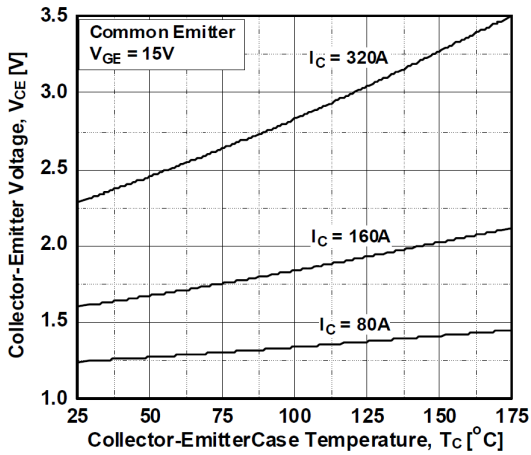

Figure 5. Saturation Voltage vs. Case Temperature at Variant Current Level

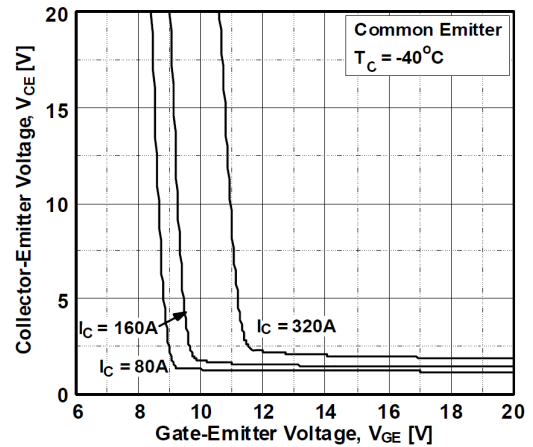

Figure 6. Saturation Voltage vs. Vge

TYPICAL PERFORMANCE CHARACTERISTICS

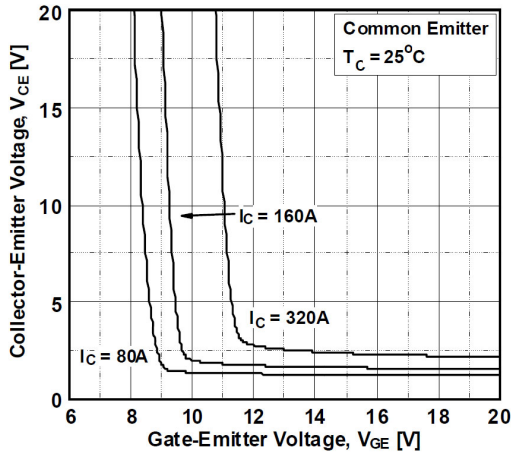

Figure 7. Saturation Voltage vs. V_{GE}

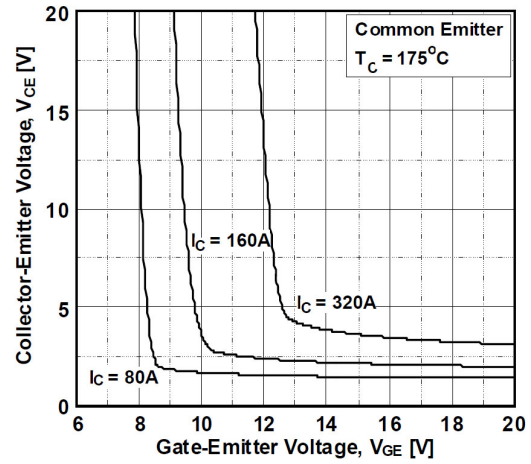

Figure 8. Saturation Voltage vs. V_{GE}

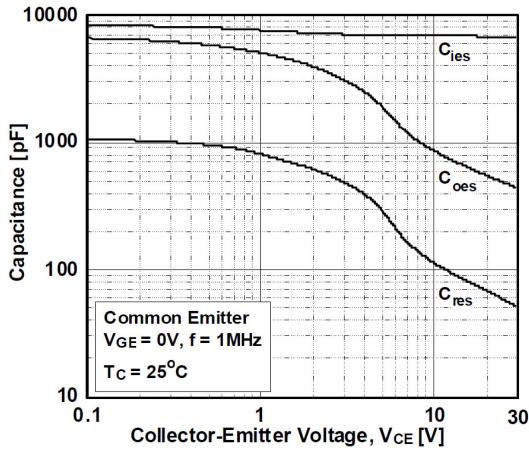

Figure 9. Capacitance Characteristics

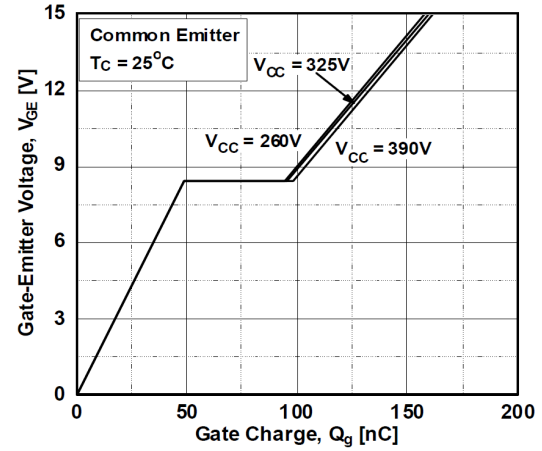

Figure 10. Gate Charge Characteristics

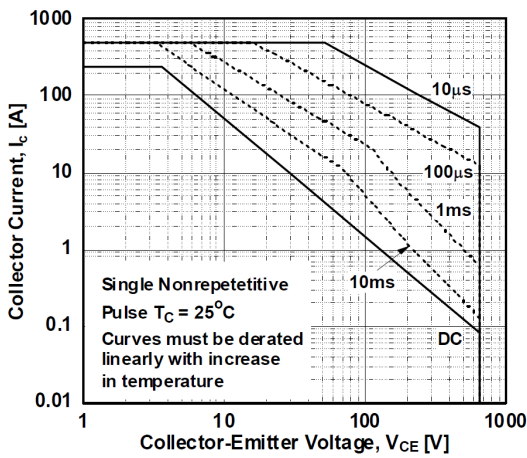

Figure 11. SOA Characteristics

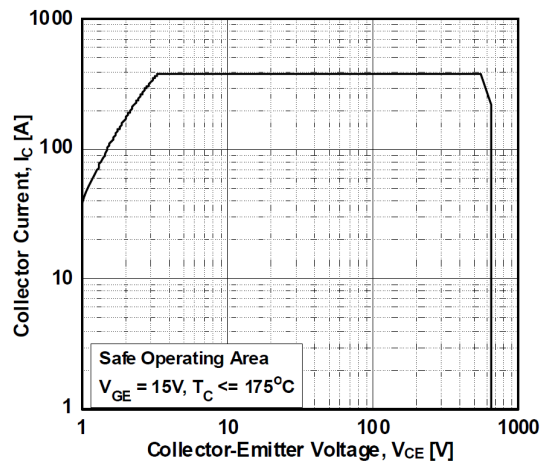

Figure 12. Turn Off Switching SOA Characteristics

TYPICAL PERFORMANCE CHARACTERISTICS

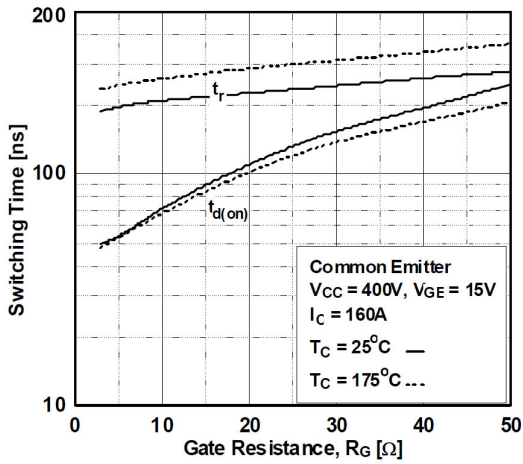

Figure 13. Turn-on Characteristics vs. Gate Resistance

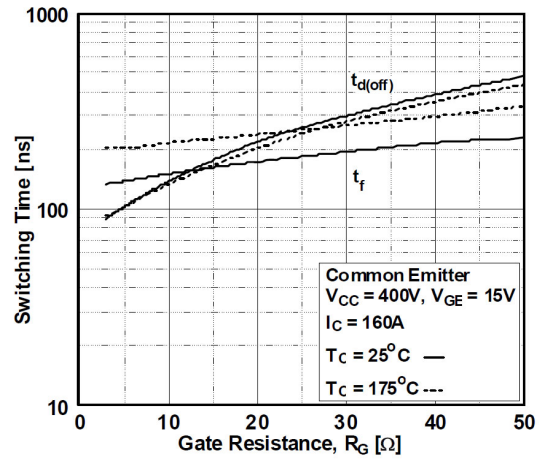

Figure 14. Turn-off Characteristics vs. Gate Resistance

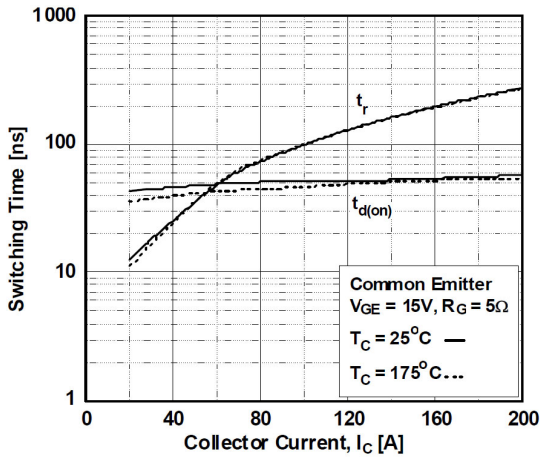

Figure 15. Turn-on Characteristics vs. Collector Current

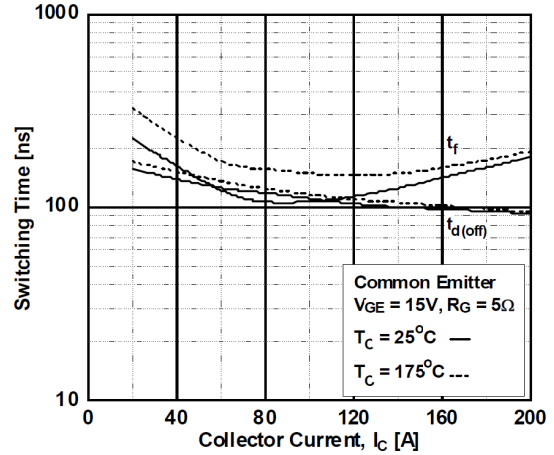

Figure 16. Turn-off Characteristics vs. Collector Current

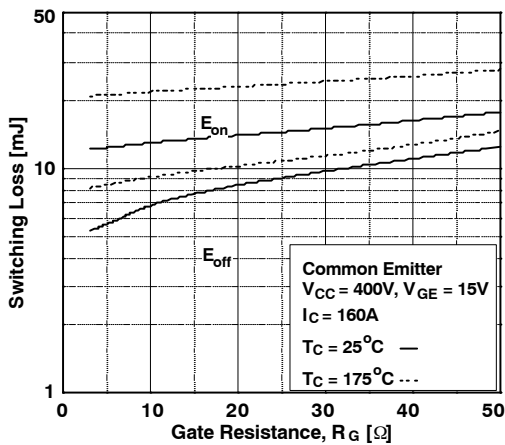

Figure 17. Switching Loss vs. Gate Resistance

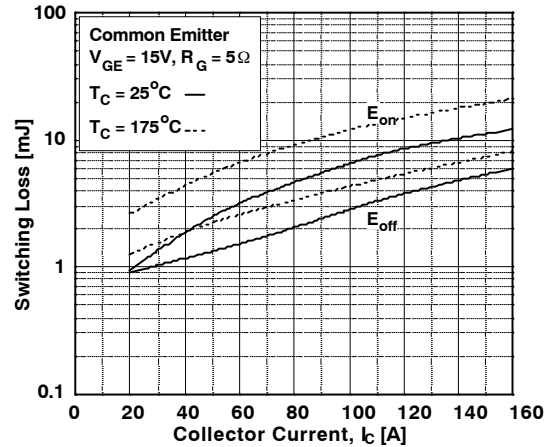

Figure 18. Switching Loss vs. Collector Current

TYPICAL PERFORMANCE CHARACTERISTICS

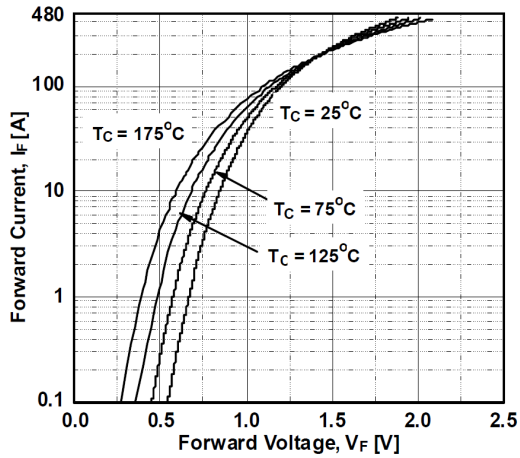

Figure 19. Forward Characteristics

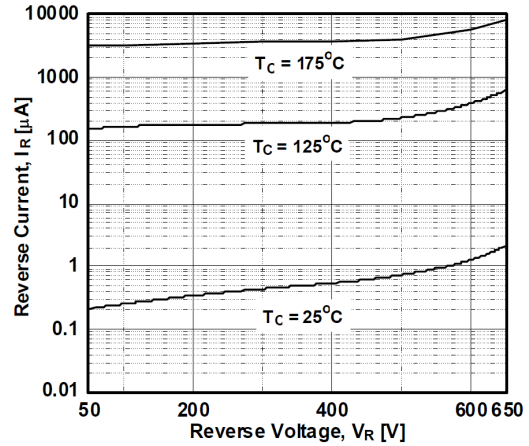

Figure 20. Reverse Current

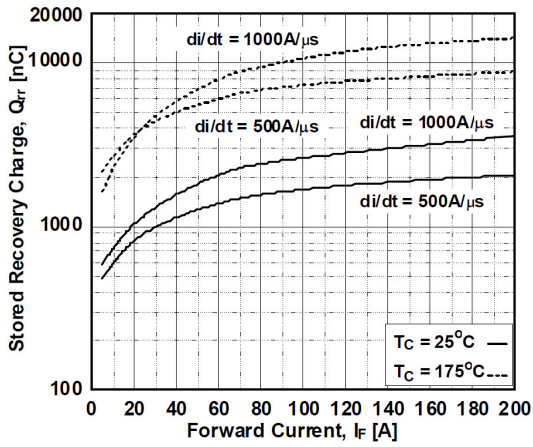

Figure 21. Stored Charge

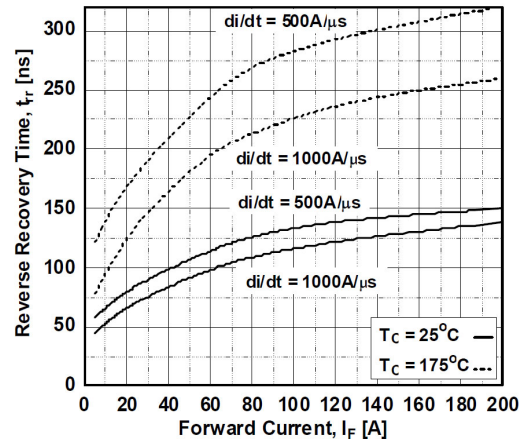

Figure 22. Reverse Recovery Time

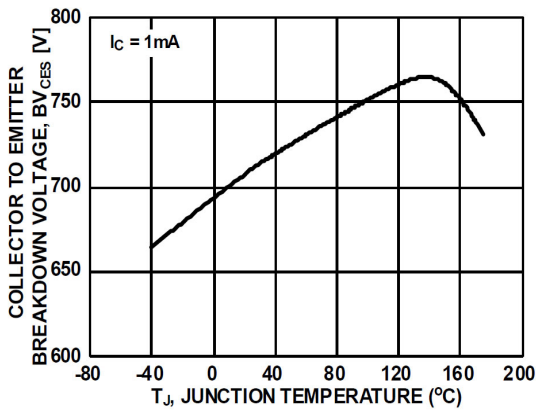

Figure 23. Collector to Emitter Breakdown Voltage vs. Junction Temperature

TYPICAL PERFORMANCE CHARACTERISTICS

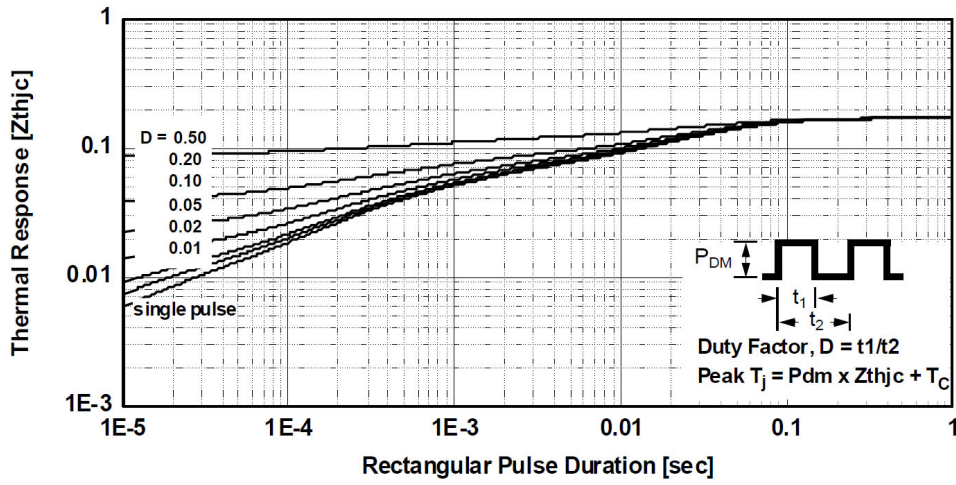

Figure 24. Transient Thermal Impedance of IGBT

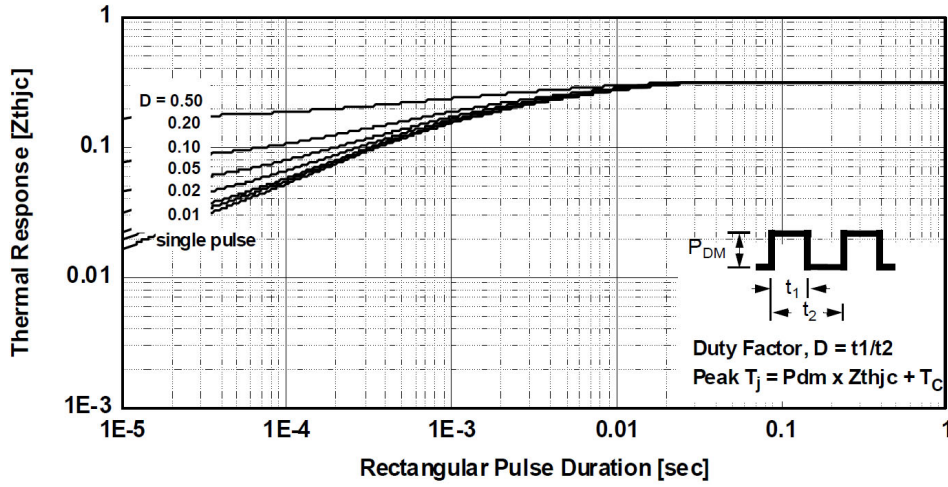
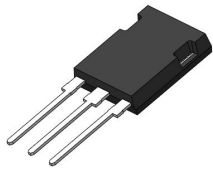

Figure 25. Transient Thermal Impedance of Diode

MECHANICAL CASE OUTLINE

PACKAGE DIMENSIONS



TO-247-3LD
CASE 340CU
ISSUE B

DATE 28 OCT 2021

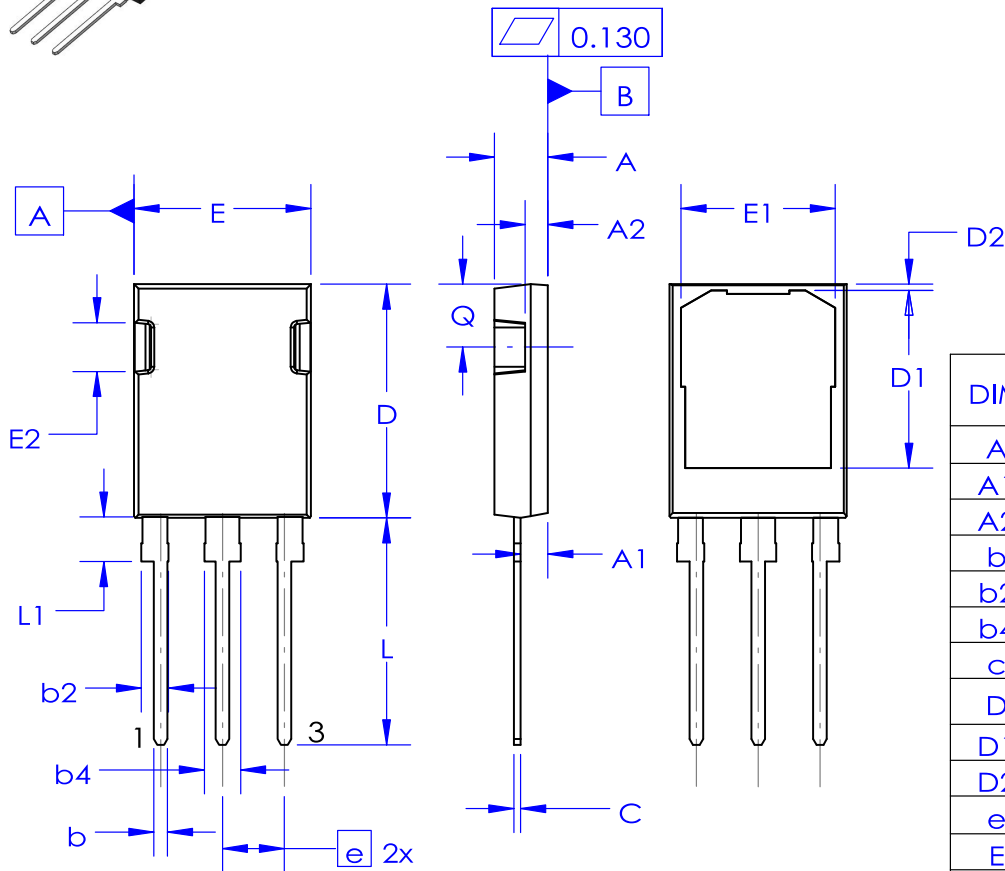

DIM	MILLIMETERS		
	MIN	NOM	MAX
A	4.60	4.70	4.80
A1	2.10	2.40	2.70
A2	1.70	2.00	2.30
b	1.16	1.20	1.26
b2	2.20	2.40	2.60
b4	3.00	3.20	3.40
c	0.59	0.60	0.66
D	20.40	20.60	20.80
D1	15.47	15.67	15.87
D2	0.25	0.55	0.85
e	5.45 BSC		
E	15.40	15.60	15.80
E1	13.40	13.60	13.80
E2	4.12	4.30	4.52
L	19.70	20.00	20.30
L1	3.65	3.85	4.05
Q	5.35	5.55	5.75

NOTES:

- A. NO INDUSTRY STANDARDS APPLIES TO THIS PACKAGE.
- B. ALL DIMENSIONS ARE IN MILLIMETERS.
- C. DIMENSIONS ARE EXCLUSIVE OF BURRS, MOLD FLASH AND TIE BAR PROTRUSIONS.
- D. DRAWING CONFORMS TO ASME Y14.5-2009.

GENERIC MARKING DIAGRAM*

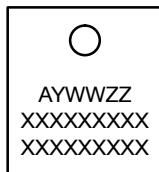

XXXX = Specific Device Code
 A = Assembly Site Code
 Y = Year
 WW = Work Week
 ZZ = Assembly Lot Code

*This information is generic. Please refer to device data sheet for actual part marking. Pb-Free indicator, "G" or microdot "μ", may or may not be present. Some products may not follow the Generic Marking.

DOCUMENT NUMBER:	98AON13773G	Electronic versions are uncontrolled except when accessed directly from the Document Repository. Printed versions are uncontrolled except when stamped "CONTROLLED COPY" in red.
DESCRIPTION:	TO-247-3LD	PAGE 1 OF 1

onsemi and ONSEMI are trademarks of Semiconductor Components Industries, LLC dba onsemi or its subsidiaries in the United States and/or other countries. onsemi reserves the right to make changes without further notice to any products herein. onsemi makes no warranty, representation or guarantee regarding the suitability of its products for any particular purpose, nor does onsemi assume any liability arising out of the application or use of any product or circuit, and specifically disclaims any and all liability, including without limitation special, consequential or incidental damages. onsemi does not convey any license under its patent rights nor the rights of others.

onsemi, **Onsemi**, and other names, marks, and brands are registered and/or common law trademarks of Semiconductor Components Industries, LLC dba "**onsemi**" or its affiliates and/or subsidiaries in the United States and/or other countries. **onsemi** owns the rights to a number of patents, trademarks, copyrights, trade secrets, and other intellectual property. A listing of **onsemi**'s product/patent coverage may be accessed at www.onsemi.com/site/pdf/Patent-Marking.pdf. **onsemi** reserves the right to make changes at any time to any products or information herein, without notice. The information herein is provided "as-is" and **onsemi** makes no warranty, representation or guarantee regarding the accuracy of the information, product features, availability, functionality, or suitability of its products for any particular purpose, nor does **onsemi** assume any liability arising out of the application or use of any product or circuit, and specifically disclaims any and all liability, including without limitation special, consequential or incidental damages. Buyer is responsible for its products and applications using **onsemi** products, including compliance with all laws, regulations and safety requirements or standards, regardless of any support or applications information provided by **onsemi**. "Typical" parameters which may be provided in **onsemi** data sheets and/or specifications can and do vary in different applications and actual performance may vary over time. All operating parameters, including "Typicals" must be validated for each customer application by customer's technical experts. **onsemi** does not convey any license under any of its intellectual property rights nor the rights of others. **onsemi** products are not designed, intended, or authorized for use as a critical component in life support systems or any FDA Class 3 medical devices or medical devices with a same or similar classification in a foreign jurisdiction or any devices intended for implantation in the human body. Should Buyer purchase or use **onsemi** products for any such unintended or unauthorized application, Buyer shall indemnify and hold **onsemi** and its officers, employees, subsidiaries, affiliates, and distributors harmless against all claims, costs, damages, and expenses, and reasonable attorney fees arising out of, directly or indirectly, any claim of personal injury or death associated with such unintended or unauthorized use, even if such claim alleges that **onsemi** was negligent regarding the design or manufacture of the part. **onsemi** is an Equal Opportunity/Affirmative Action Employer. This literature is subject to all applicable copyright laws and is not for resale in any manner.

ADDITIONAL INFORMATION

TECHNICAL PUBLICATIONS:

Technical Library: www.onsemi.com/design/resources/technical-documentation
onsemi Website: www.onsemi.com

ONLINE SUPPORT: www.onsemi.com/support

For additional information, please contact your local Sales Representative at www.onsemi.com/support/sales