

CM1410

4-Channel Headset EMI Filter Array with ESD Protection

Product Description

The CM1410 is a quad low-pass filter array integrating four pi-style filters (C-R-C) that reduce EMI/RFI emissions while at the same time providing ESD protection. This device is custom-designed to interface with the headset port on a cellular telephone, and contains three different filter values. Each high quality filter provides more than 20 dB attenuation in the 800–2700 MHz range. These pi-style filters support bidirectional filtering, controlling EMI both to and from the microphone and speaker elements. They also support bipolar signals, enabling audio signals to pass through without distortion.

In addition, the CM1410 provides a very high level of protection for sensitive electronic components that may be subject to electrostatic discharge (ESD). The CM1410 can safely dissipate ESD strikes of ± 8 kV, the maximum requirement of the IEC 61000-4-2 international standard. Using the MIL-STD-883 (Method 3015) specification for Human Body Model (HBM) ESD, the device provides protection for contact discharges to greater than ± 15 kV. The CM1410 also includes a single channel of ESD-only protection.

The CM1410 is particularly well suited for portable electronics (e.g., cellular telephones, PDAs, notebook computers) because of its small package format and low weight.

The CM1410 incorporates *OptiGuard*[™] coating which results in improved reliability at assembly. The CM1410 is available in a space-saving, low-profile Chip Scale Package with RoHS-compliant lead-free finishing.

Features

- Functionally and Pin Compatible with CSPEMI200A Device
- Pi-Style EMI Filters in a Capacitor-Resistor-Capacitor (C-R-C) Network
- Four Channels of EMI Filtering with ESD Protection
- Includes One Channel of ESD-Only Protection
- Greater than 30 dB Attenuation at 1 GHz
- ± 8 kV ESD Protection on Each Channel (IEC 61000-4-2 Level 4, Contact Discharge)
- ± 15 kV ESD Protection on Each Channel (HBM)
- Supports Bipolar Signals – Ideal for Audio Applications
- These Devices are Pb-Free and are RoHS Compliant

Applications

- EMI Filtering and ESD Protection for Audio Ports
- Wireless Handsets
- Handheld PCs / PDAs
- MP3 Players
- Digital Camcorders
- Notebooks
- Desktop PCs



ON Semiconductor®

<http://onsemi.com>



WLCSP11
CP SUFFIX
CASE 567BN

MARKING DIAGRAM

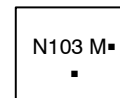

N103 = CM1410-03CP
M = Date Code
▪ = Pb-Free Package
(Note: Microdot may be in either location)

ORDERING INFORMATION

Device	Package	Shipping [†]
CM1410-03CP	CSP-11 (Pb-Free)	3500/Tape & Reel

[†]For information on tape and reel specifications, including part orientation and tape sizes, please refer to our Tape and Reel Packaging Specification Brochure, BRD8011/D.

CM1410

BLOCK DIAGRAM

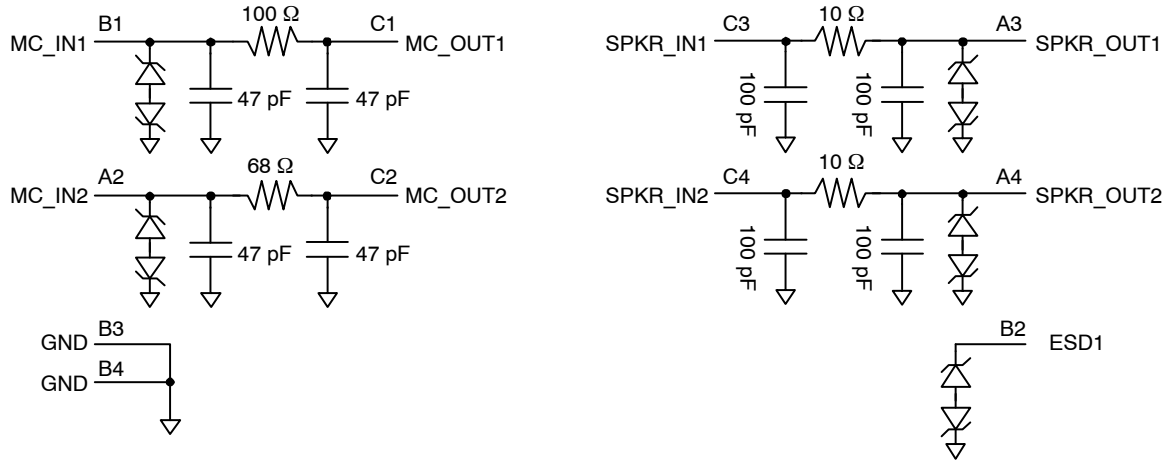
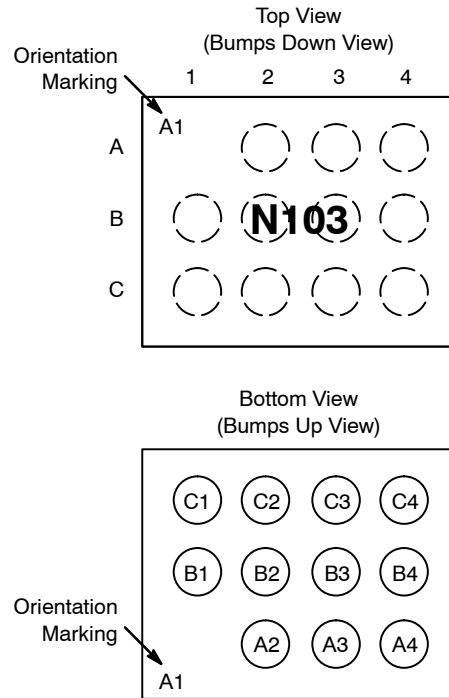

Table 1. PIN DESCRIPTIONS

11-bump CSP Package		
Pin	Name	Description
A1	N.B.	No Bump – used for orientation / alignment
A2	MIC_IN2	Microphone Input 2 (from microphone)
A3	SPKR_OUT1	Speaker Output 1 (to speaker)
A4	SPKR_OUT2	Speaker Output 2 (to speaker)
B1	MIC_IN1	Microphone Input 1 (from microphone)
B2	ESD1	ESD Protection Input. Provides a channel specifically for ESD protection purposes.
B3	GND	Device Ground
B4	GND	Device Ground
C1	MIC_OUT1	Microphone Output 1 (to audio circuitry)
C2	MIC_OUT2	Microphone Output 1 (to audio circuitry)
C3	SPKR_IN1	Speaker Input 1 (from audio circuitry)
C4	SPKR_IN2	Speaker Input 2 (from audio circuitry)

PACKAGE / PINOUT DIAGRAMS



CM1410
CSP Package

SPECIFICATIONS

Table 2. ABSOLUTE MAXIMUM RATINGS

Parameter	Rating	Units
Storage Temperature Range	-65 to +150	°C
DC Power per Resistor	100	mW
DC Package Power Rating	400	mW

Stresses exceeding Maximum Ratings may damage the device. Maximum Ratings are stress ratings only. Functional operation above the Recommended Operating Conditions is not implied. Extended exposure to stresses above the Recommended Operating Conditions may affect device reliability.

CM1410

Table 3. STANDARD OPERATING CONDITIONS

Parameter	Rating	Units
Operating Temperature Range	-40 to +85	°C

Table 4. ELECTRICAL OPERATING CHARACTERISTICS (Note 1)

Symbol	Parameter	Conditions	Min	Typ	Max	Units
R ₁	Resistance 1		90	100	110	Ω
R ₂	Resistance 2		61	68	75	Ω
R ₃	Resistance 3		9	10	11	Ω
C ₁	Capacitance 1		38	47	57	pF
C ₂	Capacitance 2		80	100	120	pF
I _{LEAK}	Diode Leakage Current	V _{IN} = 5.0 V			1.0	μA
V _{SIG}	Signal Voltage Positive Clamp Negative Clamp	I _{LOAD} = 10 mA	5 -15	7 -10	15 -5	V
V _{ESD}	In-system ESD Withstand Voltage a) Human Body Model, MIL-STD-883, Method 3015 b) Contact Discharge per IEC 61000-4-2 Level 4	(Notes 2 and 4)	±15 ±8			kV
V _{CL}	Clamping Voltage during ESD Discharge MIL-STD-883 (Method 3015), 8 kV Positive Transients Negative Transients	(Notes 2, 3 and 4)		+15 -19		V
f _{C1}	Cut-off Frequency 1 (Note 5)	R = 100 Ω, C = 47 pF		53		MHz
f _{C2}	Cut-off Frequency 2 (Note 5)	R = 68 Ω, C = 47 pF		61		MHz
f _{C3}	Cut-off Frequency 3 (Note 5)	R = 10 Ω, C = 100 pF		33		MHz

1. T_A = 25°C unless otherwise specified.
2. ESD applied to input pins with respect to GND, one at a time, pins A2, A3, A4, B1 and B2 only.
3. Clamping voltage is measured at the opposite side of the EMI filter to the ESD pin. For example, if ESD is applied to Pin B1, then clamping voltage is measured at Pin C1.
4. Unused pins are left open
5. Z_{SOURCE} = 50 Ω, Z_{LOAD} = 50 Ω

CM1410

PERFORMANCE INFORMATION

Typical Filter Performance (nominal conditions unless specified otherwise)

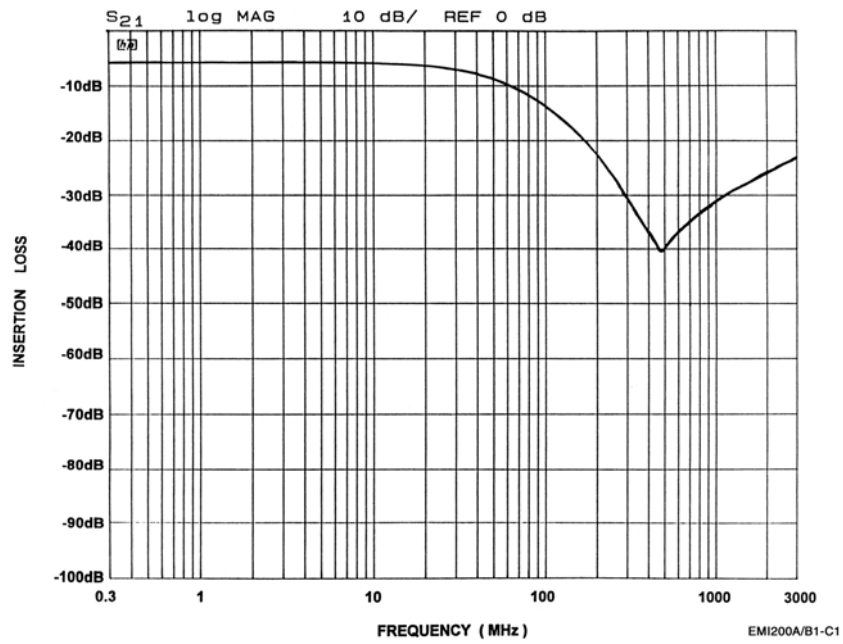

Figure 1. Microphone 1 Circuit (B1-C1) EMI Filter Performance

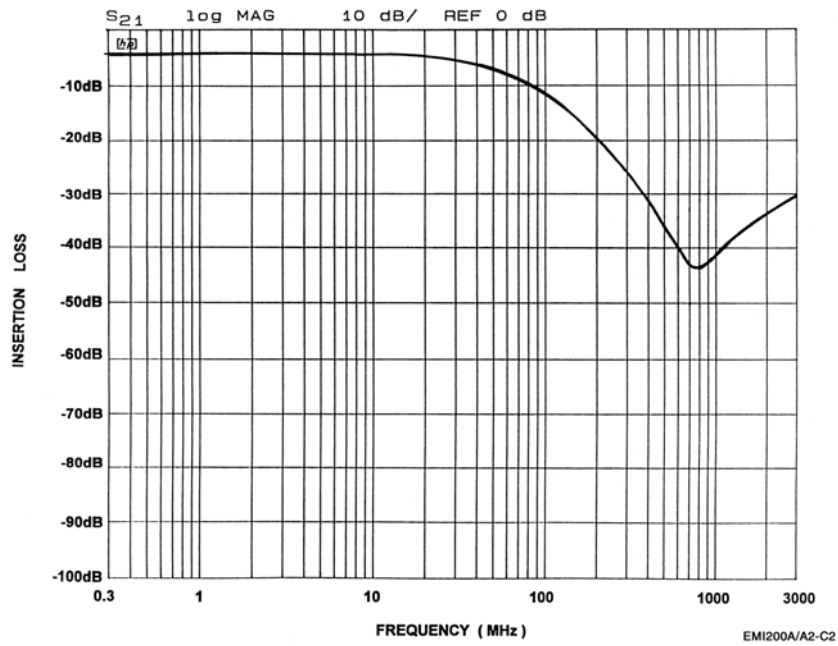

Figure 2. Microphone 2 Circuit (A2-C2) EMI Filter Performance

CM1410

PERFORMANCE INFORMATION

Typical Filter Performance (nominal conditions unless specified otherwise)

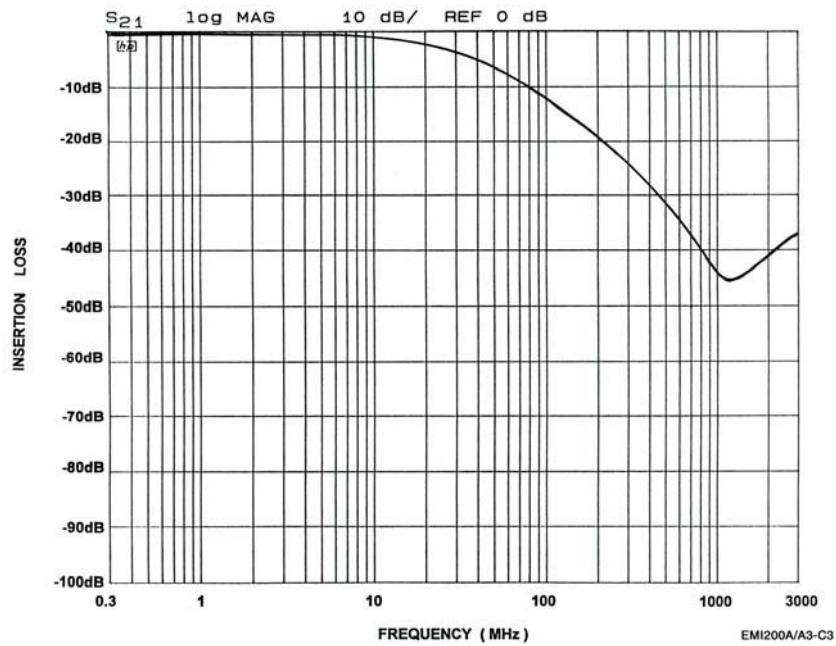

Figure 3. Speaker 1 Circuit (A3-C3) EMI Filter Performance

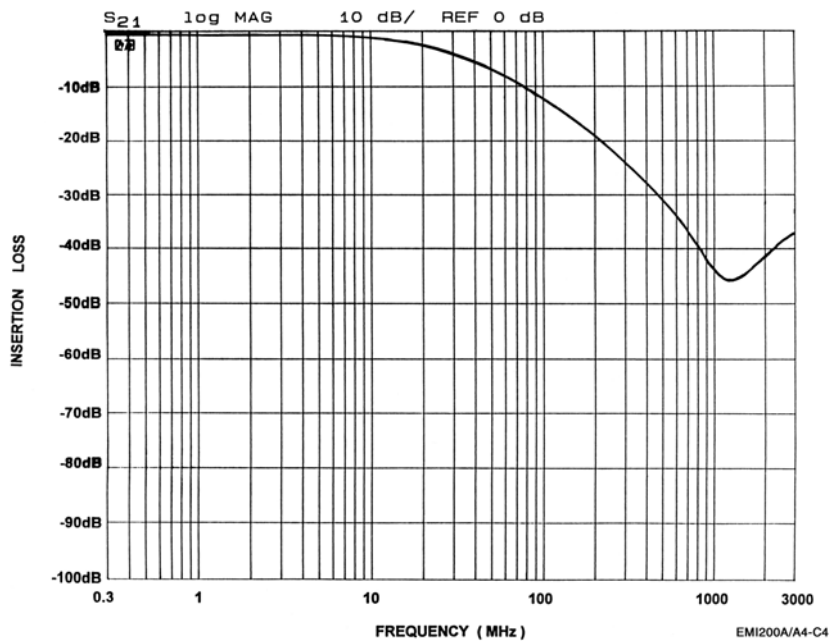

Figure 4. Speaker 2 Circuit (A4-C4) EMI Filter Performance

APPLICATION INFORMATION

Table 5. PRINTED CIRCUIT BOARD RECOMMENDATIONS

Parameter	Value
Pad Size on PCB	0.240 mm
Pad Shape	Round
Pad Definition	Non-Solder Mask defined pads
Solder Mask Opening	0.290 mm Round
Solder Stencil Thickness	0.125 – 0.150 mm
Solder Stencil Aperture Opening (laser cut, 5% tapered walls)	0.300 mm Round
Solder Flux Ratio	50/50 by volume
Solder Paste Type	No Clean
Pad Protective Finish	OSP (Entek Cu Plus 106A)
Tolerance – Edge To Corner Ball	±50 µm
Solder Ball Side Coplanarity	±20 µm
Maximum Dwell Time Above Liquidous	60 seconds
Maximum Soldering Temperature for Lead-free Devices using a Lead-free Solder Paste	260°C

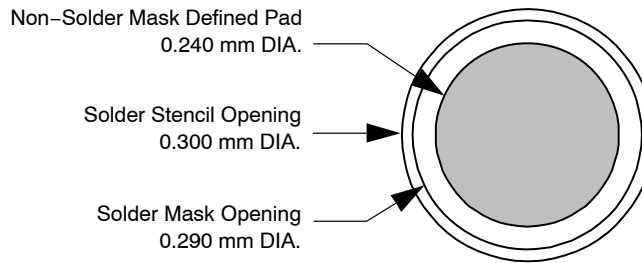

Figure 5. Recommended Non-Solder Mask Defined Pad Illustration

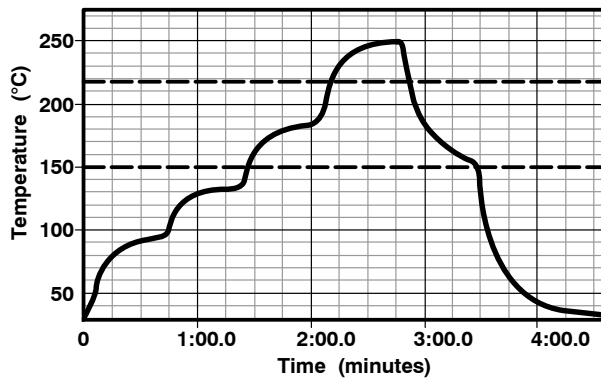

Figure 6. Lead-free (SnAgCu) Solder Ball Reflow Profile

MECHANICAL CASE OUTLINE

PACKAGE DIMENSIONS

ON Semiconductor®



SCALE 4:1

WLCSP11, 2.05x1.44
CASE 567BN-01
ISSUE O

DATE 26 JUL 2010

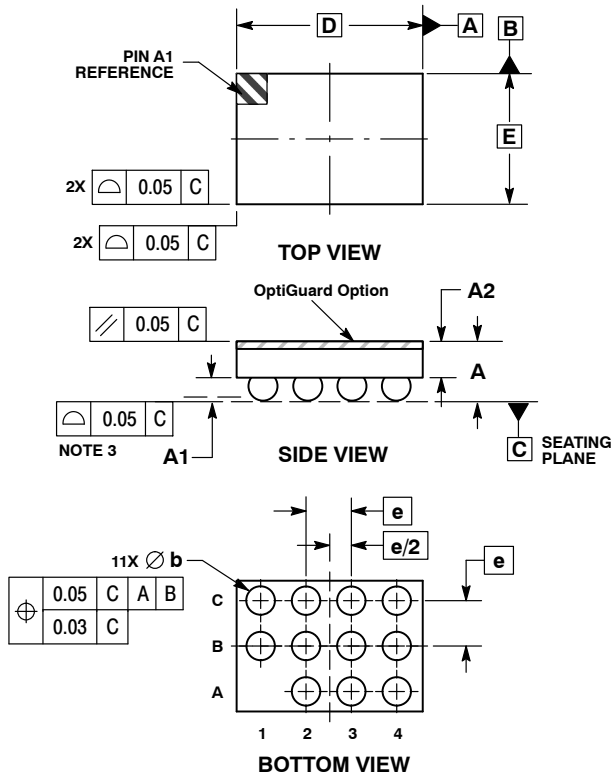

NOTES:

1. DIMENSIONING AND TOLERANCING PER ASME Y14.5M, 1994.
2. CONTROLLING DIMENSION: MILLIMETERS.
3. COPLANARITY APPLIES TO SPHERICAL CROWNS OF SOLDER BALLS.

DIM	MILLIMETERS	
	MIN	MAX
A	0.56	0.72
A1	0.21	0.27
A2	0.42 REF	
b	0.29	0.35
D	2.05 BSC	
E	1.44 BSC	
e	0.50 BSC	

RECOMMENDED SOLDERING FOOTPRINT*

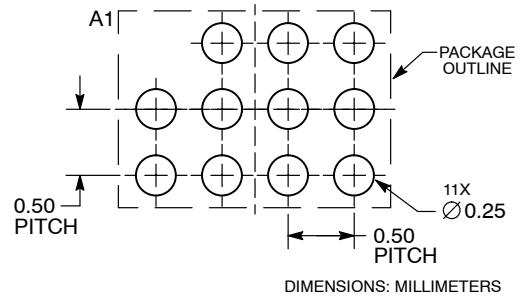

*For additional information on our Pb-Free strategy and soldering details, please download the ON Semiconductor Soldering and Mounting Techniques Reference Manual, SOLDERRM/D.

DOCUMENT NUMBER:	98AON49822E	Electronic versions are uncontrolled except when accessed directly from the Document Repository. Printed versions are uncontrolled except when stamped "CONTROLLED COPY" in red.
DESCRIPTION:	WLCSP11, 2.05X1.44	PAGE 1 OF 1

ON Semiconductor and are trademarks of Semiconductor Components Industries, LLC dba ON Semiconductor or its subsidiaries in the United States and/or other countries. ON Semiconductor reserves the right to make changes without further notice to any products herein. ON Semiconductor makes no warranty, representation or guarantee regarding the suitability of its products for any particular purpose, nor does ON Semiconductor assume any liability arising out of the application or use of any product or circuit, and specifically disclaims any and all liability, including without limitation special, consequential or incidental damages. ON Semiconductor does not convey any license under its patent rights nor the rights of others.

onsemi, **Onsemi**, and other names, marks, and brands are registered and/or common law trademarks of Semiconductor Components Industries, LLC dba "**onsemi**" or its affiliates and/or subsidiaries in the United States and/or other countries. **onsemi** owns the rights to a number of patents, trademarks, copyrights, trade secrets, and other intellectual property. A listing of **onsemi**'s product/patent coverage may be accessed at www.onsemi.com/site/pdf/Patent-Marking.pdf. **onsemi** reserves the right to make changes at any time to any products or information herein, without notice. The information herein is provided "as-is" and **onsemi** makes no warranty, representation or guarantee regarding the accuracy of the information, product features, availability, functionality, or suitability of its products for any particular purpose, nor does **onsemi** assume any liability arising out of the application or use of any product or circuit, and specifically disclaims any and all liability, including without limitation special, consequential or incidental damages. Buyer is responsible for its products and applications using **onsemi** products, including compliance with all laws, regulations and safety requirements or standards, regardless of any support or applications information provided by **onsemi**. "Typical" parameters which may be provided in **onsemi** data sheets and/or specifications can and do vary in different applications and actual performance may vary over time. All operating parameters, including "Typicals" must be validated for each customer application by customer's technical experts. **onsemi** does not convey any license under any of its intellectual property rights nor the rights of others. **onsemi** products are not designed, intended, or authorized for use as a critical component in life support systems or any FDA Class 3 medical devices or medical devices with a same or similar classification in a foreign jurisdiction or any devices intended for implantation in the human body. Should Buyer purchase or use **onsemi** products for any such unintended or unauthorized application, Buyer shall indemnify and hold **onsemi** and its officers, employees, subsidiaries, affiliates, and distributors harmless against all claims, costs, damages, and expenses, and reasonable attorney fees arising out of, directly or indirectly, any claim of personal injury or death associated with such unintended or unauthorized use, even if such claim alleges that **onsemi** was negligent regarding the design or manufacture of the part. **onsemi** is an Equal Opportunity/Affirmative Action Employer. This literature is subject to all applicable copyright laws and is not for resale in any manner.

ADDITIONAL INFORMATION

TECHNICAL PUBLICATIONS:

Technical Library: www.onsemi.com/design/resources/technical-documentation
onsemi Website: www.onsemi.com

ONLINE SUPPORT: www.onsemi.com/support

For additional information, please contact your local Sales Representative at www.onsemi.com/support/sales